



Integra[®] MicroFrance[®]
Integra ENT - Ear catalogue

Table of contents	ii - iii	Self-retaining retractor	21	Towel clamp - Forceps with teeth	42
Ordering and warranty informations	iv	straight	21	Suction tube	
Indications / Contraindications	v	with blade	21	with finger control	43 - 44
Diagnosis	2 - 4	Large self-retaining retractor	22	Ferguson-Frazier	44
Angled stylet probe caustic holder	2	Articulated self-retaining retractor	23	Frazier	44
Cotton carrier	2	Mallet	24 - 25	Jankowski	43
Kidney bowl	4	Chisel - Gouge	26	Lempert	43
Loop	3, 4	Rongeur	27	Suction irrigation tube	
Micro hook	2	Double-action rongeur	28	with finger control	43
Diagnosis forceps	5	Small scissors, pointed blades, matt finish	29	Wertheimer	43
Myringoplasty	6 - 7	Small scissors, blunt tip, matt finish	30	Micro suction tube - Adapters	45
Lancet handle	6	Metzenbaum scissors, small, matt finish	31	Curved suction tube	45
Myringotomy lancet	6	Mayo scissors, matt finish	32	Luer-lock adapter	45
Myringoplasty knife	6	Fine dissecting forceps	33	Suction tube adapter	
Scalpel handle, non sterile	7	with serrated jaws	33	with finger control	45
Sterile knife blade lancet, single use	7	with teeth	33	Micro suction tube	46
T-tube® inserter	6	with teeth and platform	33	with finger control	46
Scalpel	8	Adson dissecting forceps	34	Micro suction tube	48
Speculum	9 - 11	Medium dissecting forceps	35	Angled suction with luer-lock	48
Diagnosis speculum	9, 10	with serrated jaws	35	Blunt eyes suction tube	48
Dilator	11	with teeth	35	Malleable suction tube	48
Self-retaining speculum	11	with teeth and platform	35	Micro malleable suction tube	48
Speculum with handle	11	Medium bipolar dissecting forceps	36	Suction tube adapter	
Flexible tension arm	12 - 13	Bipolar cables	36	with finger control	48
Accessories for tension arm	12	Forceps with serrated jaws	36	Micro forceps with serrated jaws -	
Ear speculum holder	13	Forceps with smooth jaws	36	Alligator forceps	49 - 50
Tension arm	12	Forceps with teeth	36	Alligator forceps	49
Universal flexible arm	13	Medium monopolar dissecting forceps	37	Micro forceps with serrated jaws	49
Angled dissecting forceps	14	Adson forceps	37	Micro forceps with serrated jaws	50
with serrated jaws	14	Forceps with serrated jaws	37	Micro scissors -	
with smooth jaws	14	Forceps with smooth jaws	37	Micro cup forceps	51 - 52
with spoon jaws	14	Forceps with teeth	37	Microcut forceps	53
with teeth	14	Monopolar cables	37	Micro piston forceps	54 - 55
Syringe	15	Tungsten needle-holder	38	Micro knife	56
Injection needles	15	Fine haemostatic forceps	39	Micro chisel	56
Pushing syringe	15	Medium haemostatic forceps	40	Micro double instrument	56
Replacement tube	15	Haemostatic forceps, serrated jaws	41	Micro Knife	56
Syringe luer-lock	15			Oval knife	56
Washer for syringe	15			Sickle knife	56
Elevator - Raspatory	16			Suction round knife	56
Curved raspatory	17			Micro mirror - Micro raspatory -	
Retractor	18 - 19			Micro elevator	57
Curved self-retaining retractor	20			Straight curette - Micro curette	58
				Micro pick - Tenotome probe	59
				Micro hook	60

Miscellaneous micro hook -					
Micro raspatory	61	Thomassin set	78 - 79	MicroFrance® drilling	87
Micro hook	61	Angled suction tube	79	6 sided burs	87
Micro instrument, spoon handle	61	Cup forceps	79	Diamond burs	87
Micro joint knife	61	Double elevator	78	Diamond knife	87
Micro raspatory	61	Forceps, serrated jaws	79	Drill burr	87
		Hook - Raspatory	78	Perforer six sided burr	87
Micro coagulation	62	Sterilization case	79	Sterilization case	87
Bipolar cables	62	Sterilization tray	79	Sterilization tray	87
Bipolar forceps	62	Suction tube adapter	79	Tungsten helicoidal pear burr	87
Monopolar cables	62			Tungsten round burr	87
Monopolar curved elevator	62	Presutti set for endoscopic surgery of			
Monopolar pick	62	the ear	80 - 81	Stainless steel cup, tray -	
		Alligator forceps	81	Surgical instrument oil	88
Micro measuring rod	63	Curved curette double-ended	80	Cup	88
		Fascia press	81	Sterilization tray	88
Prosthesis placement	64 - 65	Lancet knife	80	Surgical instrument oil	88
Cartilage cutting block	65	Sterilization case	80		
Fascia press	65	Sterilization tray	80	Stainless steel sterilization tray	
Hubbard instruments	64	Suction tube elevator	80	and case	89
Ossicle holding clamp	64	Suction tube with finger control	81		
Ossiculoplasty sizer	64	Wire crimper forceps	81	Aluminum and plastic	
Punch for silastic	64			sterilization case	90
Replacement blade for		Otoneurosurgery	82 - 84		
cartilage cutting block	65	Ball seeker	84	Numerical index	91
Schuknecht device	64	Blunt eyes suction tube	82		
Wire guide	64	Cup forceps	84	Table for corresponding manufacturer	
		Curved elevator	84	part numbers for information purposes	
Piston placement	66	Fenestrated curette	84	only	97
Hand drill perforator	66	Hook	84		
Piston trimming gauge	66	Knife	84	Global alphabetical index	99
Preparation glass plate	66	Micro forceps	83		
Teflon cutting block	66	Micro pick	84	Alphabetical index	
		Micro scissors	83	Search by name	103
Otoplasty - Suction foot switch -		Raspatory	84		
Holder	67	Self-retaining retractor	83		
		Suction irrigation tube with finger control	82		
Cause set	68	Suction tube with finger control	82		
Marquet micro instruments	70	Selesnick set	85 - 86		
		Bipolar forceps	86		
Austin micro instruments	71	Cup forceps	85		
		Curette	85		
Guilford-Wright, Shea		Curved self-retaining retractor	86		
micro instruments	72	Elevator	85		
		Hook	85		
Hough micro instruments	73	Knife	85		
		Scissors	85		
House micro instruments	74 - 75	Sterilization case	86		
Jordan, Rosen, Paparella					
micro instruments	76				
McCabe micro instruments	77				

Pricing :

Prices stated in specific written quotations are firm for thirty days from the date given, and are otherwise subject to change without prior notice. Pricing terms stated on written agreements are governed by such agreements.

Minimum Order Requirements :

The minimum ordering amount is €250 (Integra reserves the right to apply €20 handling fees and transport fees for any order below €250). For partial unit orders, please contact the customer service to obtain a quote.

Administrative fees :

Administrative fees may be charged for any order.

Ordering Procedure :

A written purchase order is required for the purchase of Integra MicroFrance® products.

Acceptance of Orders :

Orders are accepted upon approval by Integra Customer Service.

Return Policy :

- Authorization from Customer Service must be obtained prior to returning product.
- Sterile product must be returned in unopened, undamaged cartons, packed to prevent damage.
- Non-sterile product must be returned in unused saleable condition in original package.
- No credit will be issued for special orders.
- A credit note will be issued for products returned less than ninety days from shipment date with a 20% restocking fee, provided that the product being returned is not damaged and it is possible to verify that the product has not been used or opened.

Integra Limited Warranty

Please refer to the warranty included in the packaging of each product to know the applicable warranty.

Contacts Customer service :**International**

+33 (0) 4 37 47 59 50
+33 (0) 4 37 47 59 25 (fax)
csemea@integralife.com

France

+33 (0) 4 37 47 59 10
+33 (0) 4 37 47 59 29 (Fax)
custsvcfrence@integralife.com

Benelux

+32 (0) 2 257 4130
+32 (0) 2 253 2466 (Fax)
custsvcbenelux@integralife.com

United Kingdom

+44 (0) 1264 345 780
+44 (0) 1264 363 782 (Fax)
custsvcs.uk@integralife.com

Germany

+49 (0) 2102 5535 6200
+49 (0) 2102 5536 636 (Fax)
custsvcgermany@integralife.com

Italy

+39 (0) 2 577 8921
+39 (0) 2 575 113 71 (Fax)
custsvcitaly@integralife.com

MicroFrance® ENT Instrumentation

INDICATIONS

- All the medical devices showed in this catalogue have indications for diagnosis and/or ENT surgery.
- Sizes are not contractual and are given for information purposes only.

CONTRAINDICATIONS

- Do not use in indications other than the indications mentioned in the DFU or Labeling.

How to read the catalogue

Diagram illustrating the layout of the catalogue page for ENT instrumentation, showing various instruments and their corresponding tables.

Annotations:

- Title and/or product family
- Detail view of the instrument
- Instrument to a 1/1 scale except mentioned otherwise
- Explanatory table see below

Micro crochets mousses 90°			Micro crochets mousses 45°		Porte-coton bout torsillé	Sonde stylet caudé à plaque protège-auriculaire
MCO805	MCO806A	MCO806	MCO807	7719-2	7721	
16mm	16mm	16mm	16mm	140mm	110mm	longueur utile 80mm
2mm	2,5mm	0,8mm	1mm	Ø 1,2mm		

DOCUMENT DESTINÉ À L'EUROPE, AU MOYEN-ORIENT ET À L'AFRIQUE. 3

Explanation of the table reference and complementary product description

Title or subtitles	
Global complementary description	
Product ref.1	complementary description 1
Product ref.2	complementary description 2

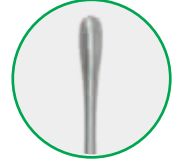
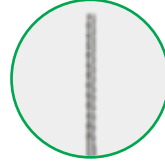
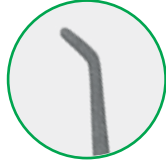

Marquet

Legent



Micro blunt hook
90°

165mm

MCO805	MCO805A	MCO950
2mm	2.5mm	0.8mm



Micro blunt hook
45°

165mm

MCO807

1mm



Cotton carrier, twist end
15mm

140mm

7719-2

Ø 1.2mm



Angled stylet probe
caustic holder

110mm

7731

working length 80mm

Billeau

Snellen

Trautmann

Saint-Paul



Oval loop

160mm	140mm	200mm	170mm	90mm
7718	7885	7885A	7888	7886
4mm	4.5mm	4mm	4mm	2.5mm

Buck



Loop 45° 165mm

3724013 2x3mm n° 1

Sprague



Loop 180mm

3724024 Ø 3mm



Picture for information, without scale

Stainless steel kidney bowl

7875^(D)

^(D) Distributed by Integra MicroFrance SAS (France) - For corresponding manufacturer part numbers, see table in annex

«L» Working length

Micro forceps

Corgill-Hartmann

3724265

2x3mm

L 100mm



Strümpel

3721005

2.5x5mm

L 80mm



Hartmann

3721000

2x6mm

L 65mm



Tobey

3721001

2x4mm

L 65mm



“LU” Longueur utile

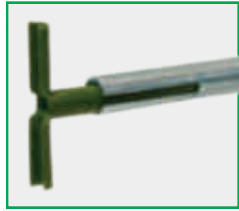

T-tube® 12mm inserter

MCO781

LU 95mm



Politzer

Myringotomy lancet

80mm - Pack 3

7725P1	7725P2	7725P3
N° 1	N° 2	N° 3



Politzer

Lancet handle

85mm

7725

Myringotomy lancet angled shaft

170mm

7721-1



Myringoplasty double knife 2x3mm 165mm

3722151

3722149 90° et 120°

3722150 90° et 115°

3722151 25° et 45°



Myringotomy knife blade, sterile, disposable, handle included, Pk 10

Scale 2/3



Myringotomy knife spear blade

1411000



Myringotomy knife lancet blade

1411050

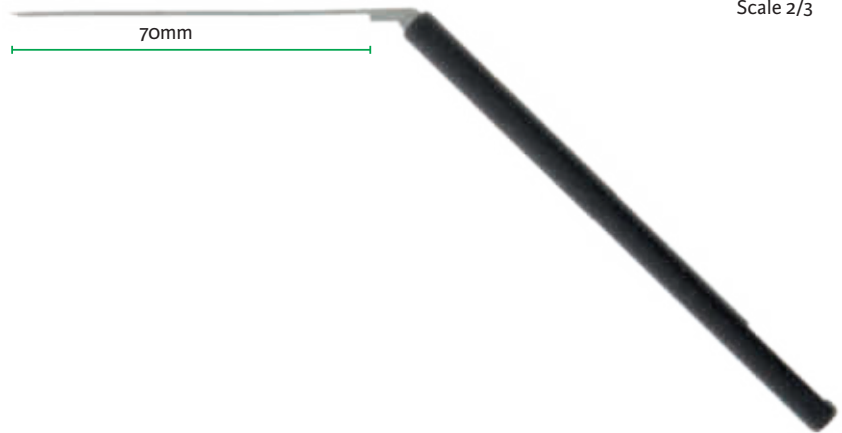

Scalpel handle, non sterile

Chuck



Micro otologic blade, sterile, disposable, Pk 5

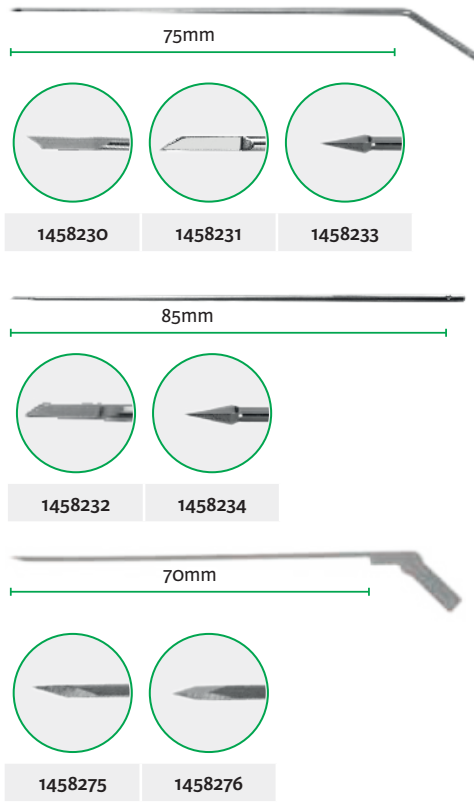

Knife blade, sterile, disposable, Pk 25



^(D) Distributed by Integra MicroFrance SAS (France) - For corresponding manufacturer part numbers, see table in annex



120mm

160mm

200mm

150mm

120mm

1003IG^(D)

1005I^(D)

1003LI^(D)

CP821

1004IG^(D)

N° 3

N° 7

N° 3L

N° 4

use with blades 11/15

blades 23

^(D) Distributed by Integra MicroFrance SAS (France) - For corresponding manufacturer part numbers, see table in annex

Le Mée



45mm

Farrior



43mm





Legent



40mm

Diameter	45mm	43mm	Pack 1, unit	Pack 100, non sterile, individual packaging
○ 2mm	Pack 1, unit		Pack 1, unit	
○ 2,5mm	9913-1 ^(D)	-	-	-
○ 3mm	9913-2 ^(D)	-	-	-
○ 4mm	9913-3 ^(D)	-	8812-1	8814T1
○ 4,5mm	9913-4 ^(D)	-	-	-
○ 5mm	-	-	8812-2	8814T2
○ 5,5mm	9913-5 ^(D)	-	8812-3	8814T3
○ 6mm	-	-	8812-4	8814T4
○ 7mm	9913-6 ^(D)	3724102	8812-5	8814T5
○ 8mm	9912-7 ^(D)	3724103	-	-
○ 9mm	9912-8 ^(D)	3724104	-	-
○ 9mm	9912-9 ^(D)	-	-	-

^(D) Distributed by Integra MicroFrance SAS (France) - For corresponding manufacturer part numbers, see table in annex

	Shape	Size	Diameter	N°	Reference
 <p>Farrior</p>	Oval	43mm	4,5x5,5mm	1	3724108
			5,5x6,5mm	2	3724109
			6,5x7,5mm	3	3724110
			7,5x8,5mm	4	3724111
			8x10mm	5	3724112
			9x11mm	6	3724113
			10x12mm	7	3724114
 <p>Farrior</p>	Oblique oval	43mm	5x6mm	1	3724122
			8x10mm	4	3724125
			9x11mm	5	3724126
			10x12mm	6	3724127
			11x13mm	7	3724128
 <p>Gruber</p>	Oval	37mm	4x5,5mm	3	3724161
 <p>Hartmann</p>	Round	35mm	5mm	2	3724142
			6mm	3	3724143
			7mm	4	3724144
 <p>Black finish</p>	Oblique oval	42mm	3x4mm	1	3724401
			3,5x4,5mm	2	3724402
			4x5mm	3	3724403
			4,5x5,5mm	4	3724404
			5x6mm	5	3724405
			5,5x6,5mm	6	3724406
			6x7mm	7	3724407
			6,5x7,5mm	8	3724408
			7x8mm	9	3724409
			7,5x8,5mm	10	3724410
			8x9mm	11	3724411



Hartmann

160mm

7898

Tieck-Halle



130mm

7897

Beckman



140mm

7899

Left hand

Vienna



140mm

MCO233

Dilator



140mm

MCO237

self-retaining
serrated blades

Tension arm



Legent

Flexible tension arm, complete

MCO980

delivered with MCO981, MCO982 et MCO983



Darrouzet

Flexible tension arm

MCO978

delivered with MCO978S

Table clamp



CEV984

CEV985

Accessories for tension arm



Ear quick-lock speculum

MCO981



Nasal speculum holder

MCO982



Articulated kneecap

MCO983-4



Malleable blade

MCO983

Devèze



Self-retaining speculum

MCO981D



MCO978S

Universal flexible arm

Scale 1/2

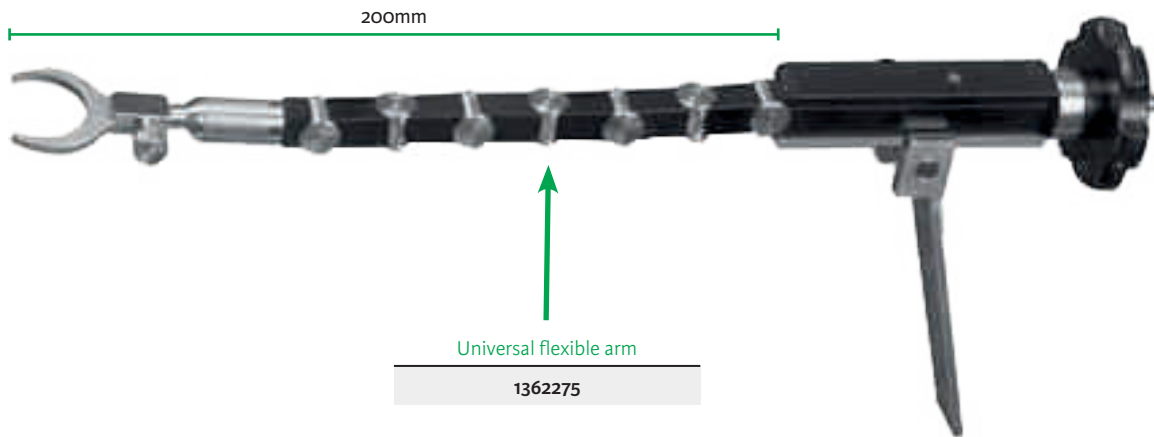

Ear speculum holder

Scale 1/3

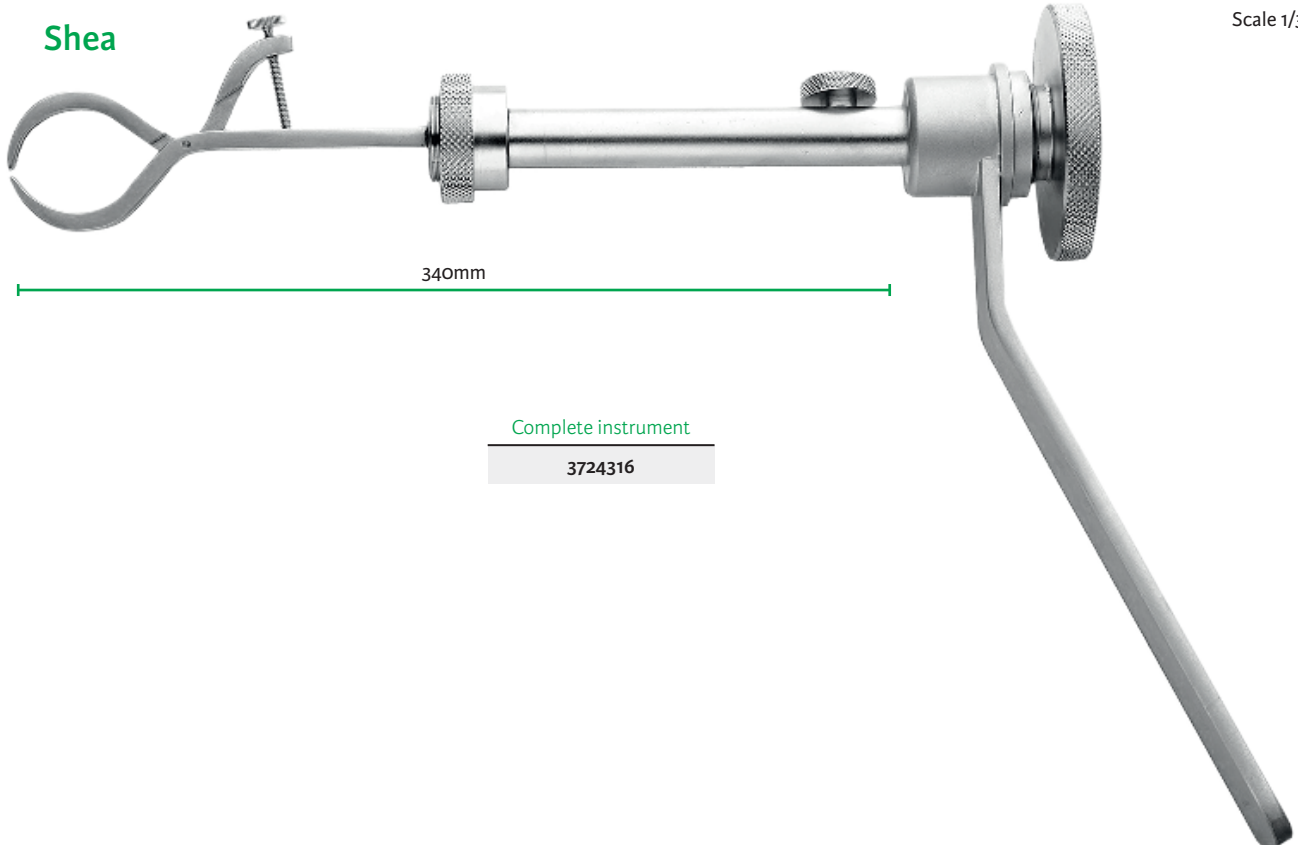



200mm

9511007

smooth jaws
2x18mm

Lucae



7726MF

150mm

7726MF

7727

7728

serrated jaws
1x12mm

spoon jaws

1x2 teeth

Politzer



7732-1

120mm

7732-1

7733

7734

serrated jaws
1,5x14mm

spoon
jaws

1x2 teeth

Syringe luer-lock high pressure 5cc

Génia

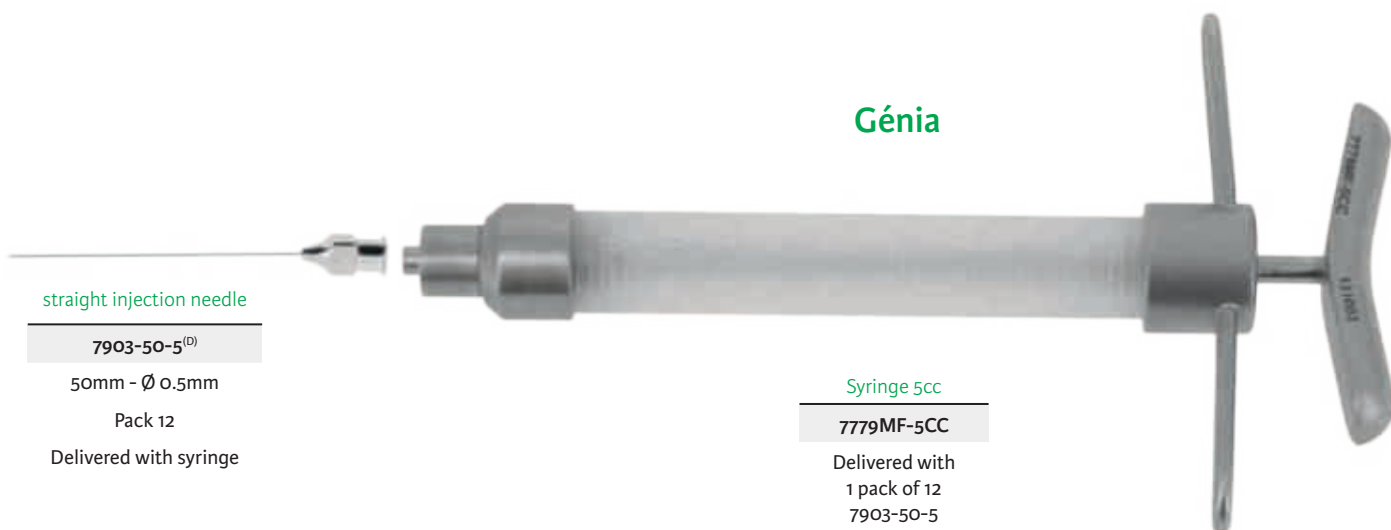

straight injection needle

7903-50-5^(D)

50mm - Ø 0.5mm

Pack 12

Delivered with syringe

Syringe 5cc

7779MF-5CC

Delivered with
1 pack of 12
7903-50-5



Silicone grey washer luer

7779MF-2

Pack 6



Replacement tube

7779MF-3



Silicon white washer piston

7779MF-1

Pack 6



Chouard

Pushing syringe

7783-12

Pack 2

for disposable syringe luer-lock 12cc



Injection needles

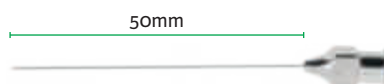

50mm

7903-50-5^(D)

Ø 0.5mm

Pack 12

for syringe 7779MF-5CC

^(D) Distributed by Integra MicroFrance SAS (France) - For corresponding manufacturer part numbers, see table in annex

Sébileau



190mm

CP985

5mm

Fleury



180mm

MCO305

8.5mm

Freer



160mm

MCO803

2.5mm

Freer



185mm

CP611

5mm

Howarth



220mm

CP625

Cottle



220mm

CP626

McKenty



240mm

CP627

Farabeuf

Fleury

Sébileau

Plester

Lempert



150mm

7787-10

10mm



170mm

MCO979

6,5mm



150mm

CP825

4mm



180mm

MCO988

7,5mm



185mm

3724060

7mm



195mm

3724059

6,5mm

Farabeuf

Desmarres

Gillies

Gillies

Humby



120mm	140mm
7768	7768-1
Pack 2	Pack 2



140mm
CP822-12
12mm
CP822-10
10mm
CP822-14
14mm



180mm
CP17
3mm
CP17-1
2mm



145mm
CP17-3
2mm
CP17-2
3mm



145mm
CP628
5mm



110mm
CP941
articulated

Knapp



150mm

3714027

8mm

3714028

blunt

Volkmann



140mm

CP21-3

sharp

CP21A-3

blunt



150mm

7782-1-2



180mm

CP335

Senn-Miller



160mm

CP609

3 sharp prongs

Weitlaner

110mm

O-28-8



Schuknecht

130mm

O-28-2



Weitlaner-Wullstein

130mm

O-28-1



Weitlaner

130mm

O-28

3x4 sharp prongs

Self-retaining retractor with blade



Plester

110mm

0-28-3	0-28-4
sharp prongs right	sharp prongs left



Bellucci-Wullstein

125mm

3724069
blunt prongs right



Perkins

130mm

3724067	3724066
blunt prongs right	blunt prongs left

Straight self-retaining retractor



Paparella-Weitlaner

135mm

3724068



Weitlaner

Curved retractor

160mm

0-28-7

sharp prongs



3724244

Weitlaner

straight retractor

165mm

200mm

3724244

3724247

sharp prongs

sharp prongs

Bizeau

165mm

MCL359

3 blades 20x30mm

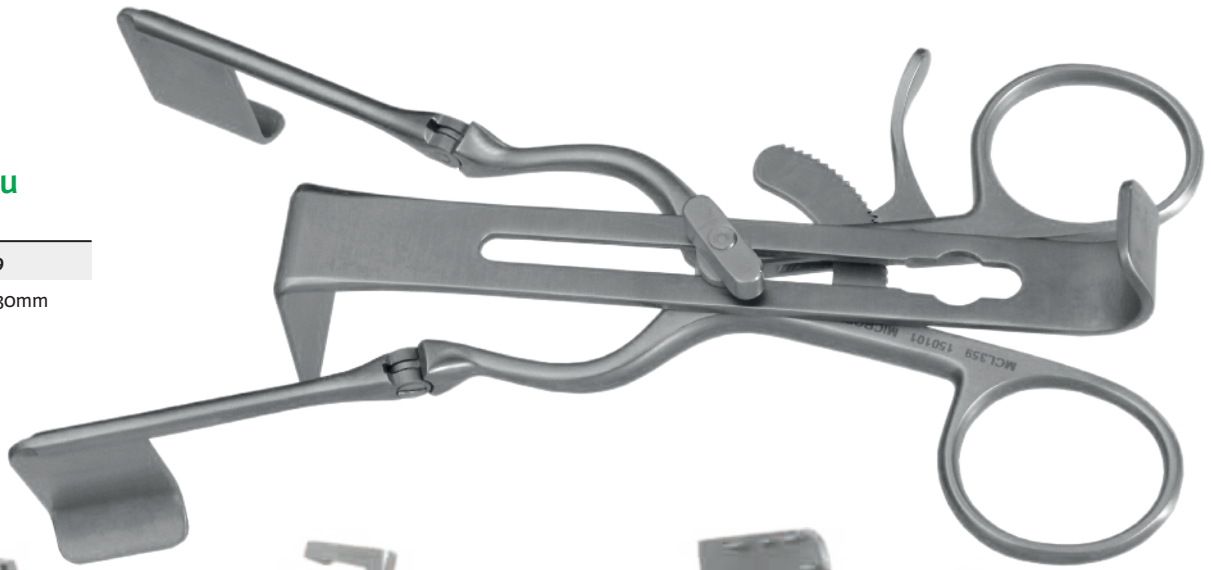

Weitlaner-Beckmann

165mm

7781



House

165mm

1352247

blunt
prongs
right

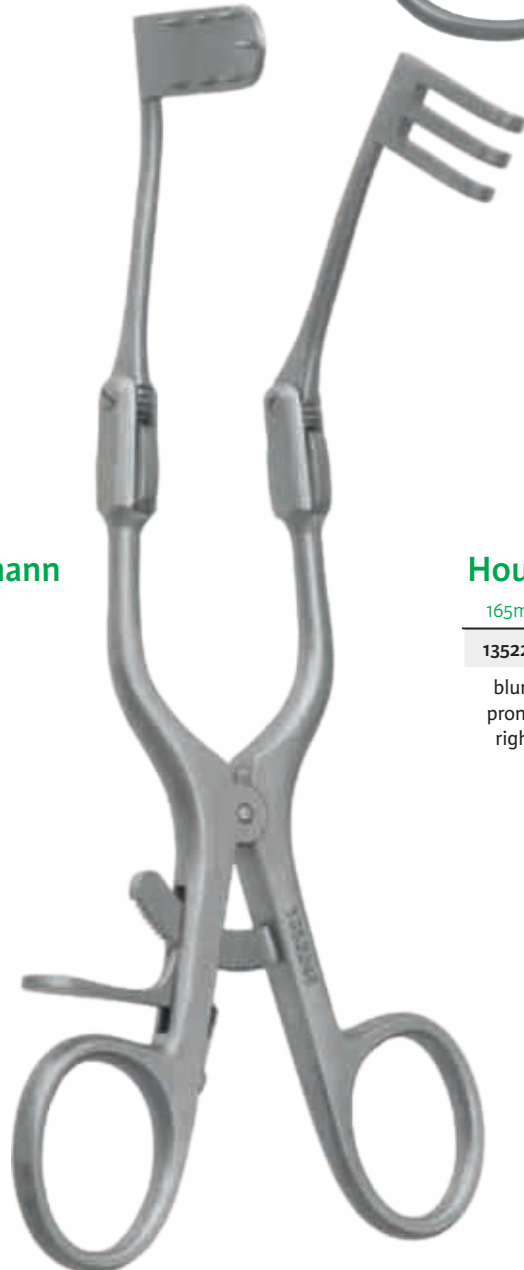

Lombard

165mm - 110g

MCO995



185mm - 330g

7766



180mm - 200g

CP907

1 teflon head



180mm - 230g

CP300



Jost



180mm

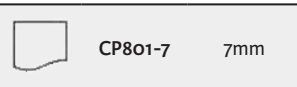

Fleury



150mm

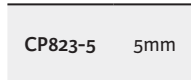

150mm

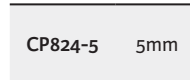

130mm

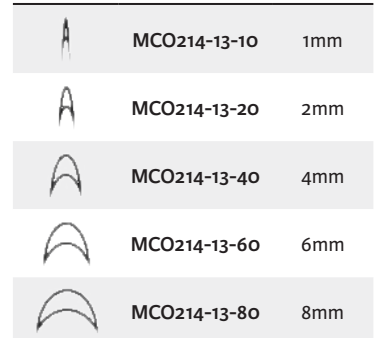

Scale 1/2

60mm

Citelli



7764

3mm



100mm

Kerrison-Costen



3712021

4mm



100mm

Kerrison

3724074	3.5mm
3712015	4mm
3712016	4.5mm
3712017	5mm





CP380

Beyer

160mm

CP380	CP380-2
straight jaws 2mm	curved jaws 2mm



CP380-3

Beyer

180mm

CP380-3	CP380-5	CP380-1
curved jaws 2mm	curved jaws 4mm	straight jaws 2mm

Streiff

105mm

CP16-1	CP16
curved blades	straight blades



100mm

CP353
strong curvature



Offret

100mm

CP356



Joseph

120mm

CP354A	CP354
curved blades	straight blades



Joseph

110mm

CP919A	CP919
curved blades	straight blades



Fox

110mm

CP358A	CP358
curved blades	straight blades



Shea

120mm

CP637

curved blades



Bregeat

110mm

CP363

curved blades



Stevens

110mm

CP922A

curved blades
Tenotomy

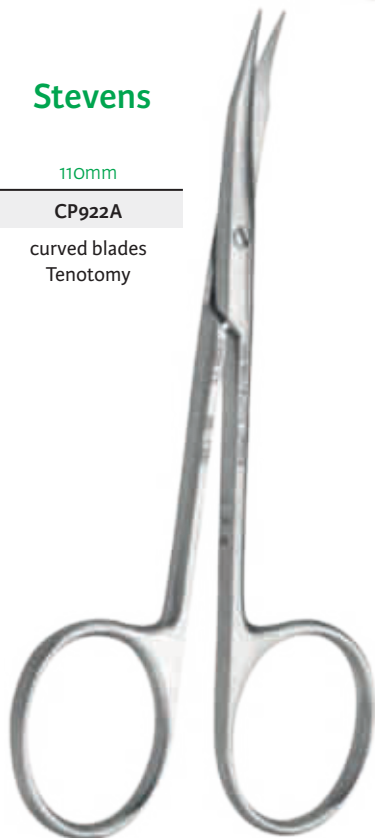

Stevens

110mm

CP922

straight blades
Tenotomy



Stevens

115mm

CP922B

curved blades
Tenotomy



Metzenbaum

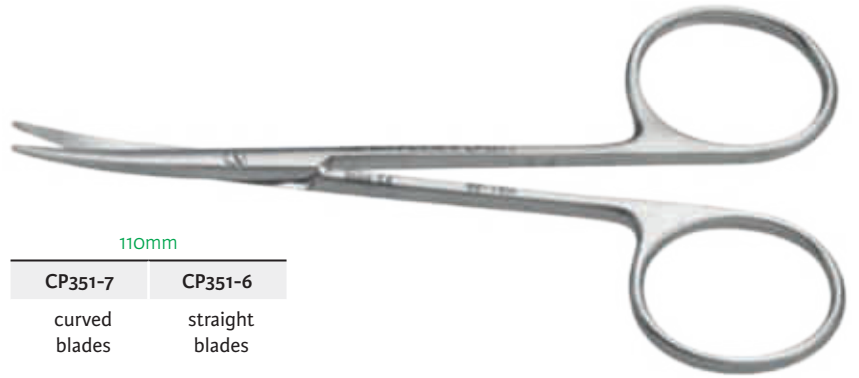

110mm

CP351-7	CP351-6
curved blades	straight blades

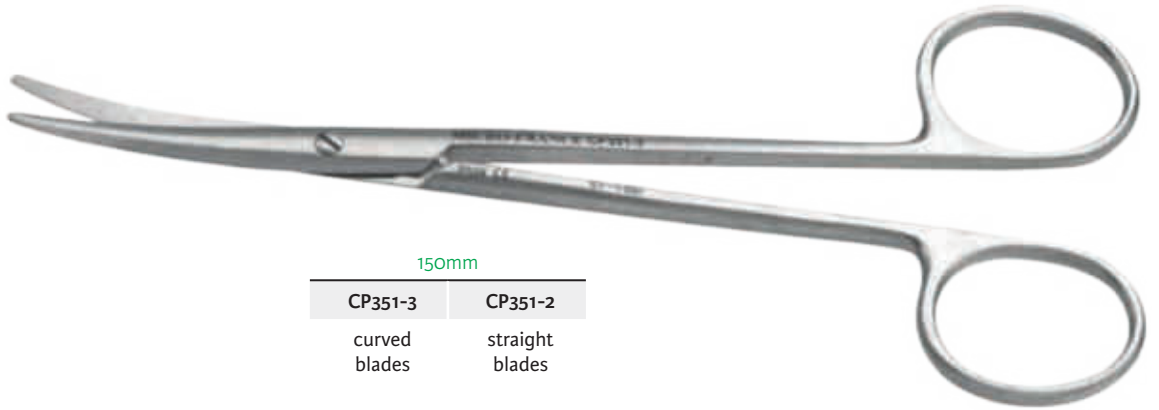

150mm

CP351-3	CP351-2
curved blades	straight blades

Delicate blades



150mm

CP931-1	CP931
curved blades	straight blades

Mayo



150mm

CP352

straight blades

150mm

CP352-1

curved blades

170mm

CP352-2

straight blades

170mm

CP352-3

curved blades

Dissecting forceps 110mm



Dissecting forceps 120mm

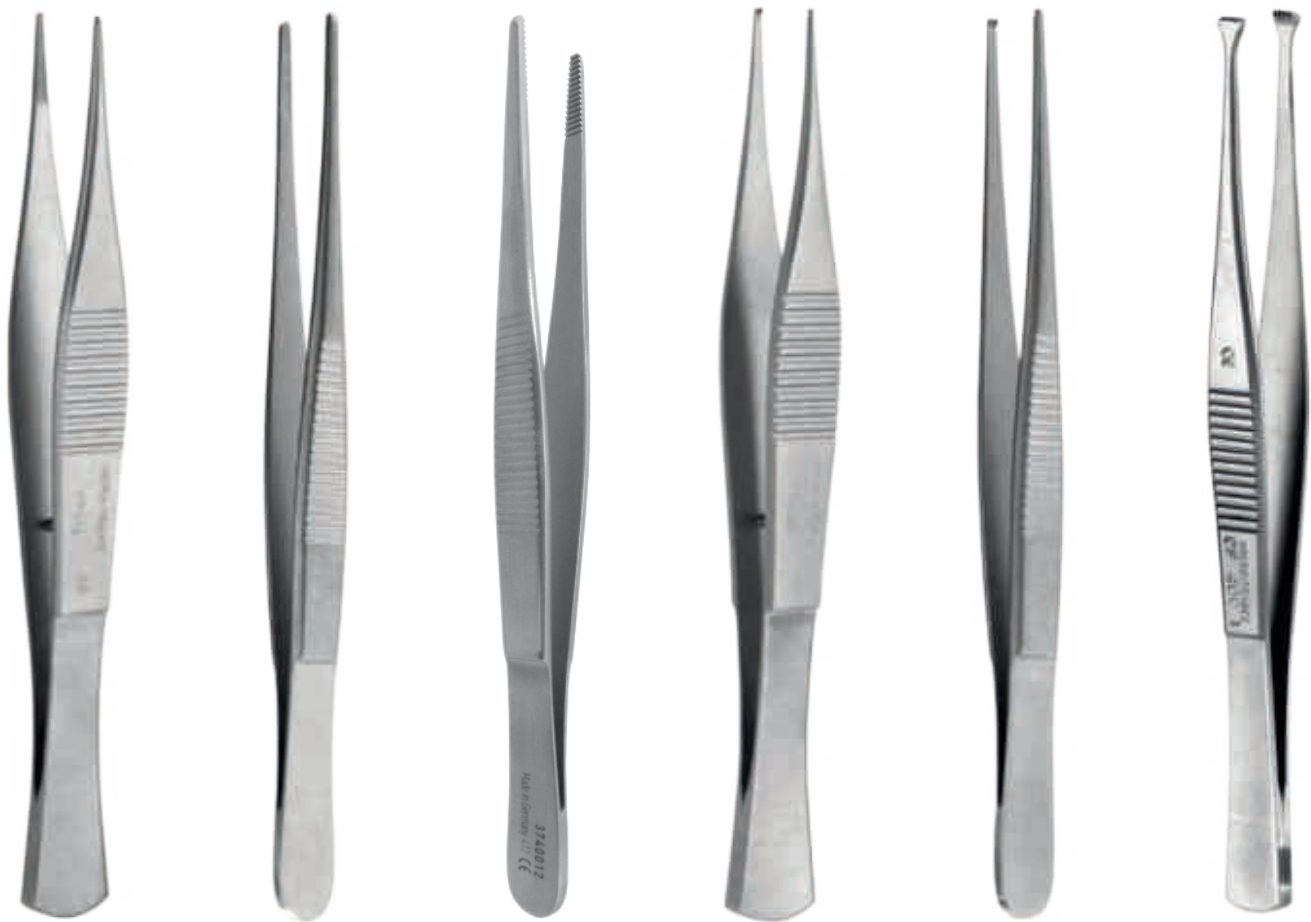

serrated jaws

jaws with teeth

CP414	7831A-12	3740012	CP406	7833A-12	CP400-1
Jaws 1mm	Jaws 1.5mm	Jaws 3mm	1x2 teeth - Jaws 1mm	1x2 teeth - Jaws 1.5mm	5x5 teeth

150mm

Adson



CP604-15 serrated jaws 1.5mm

CP605-15 1x2 teeth 1.5mm

Adson-Brown



CP606-15 7x7 teeth

120mm



Adson-Tubiana

Adson

Adson-Brown

Jaws 1mm		Jaws 1,5mm		Jaws 2mm	Jaws 1,5mm	7x7 teeth	
M832	M833	CP604	CP605	3740028	CP606A	CP606	3740038
serrated	1x2 teeth	serrated	1x2 teeth	2x3 teeth	serrated tungsten jaws		angled jaws

Mac-Indoe

140mm



CP934 oblique
1x2 teeth
and serrated
platform

CP934-1 serrated
jaws

Debakey Barraya



150mm

140mm

CP415	7831A-15	CP407	7833A-15	CP988-15	CP933-14	CP400
serrated jaws 1mm	serrated jaws 1.5mm	1x2 teeth jaws 1mm	1x2 teeth jaws 1.5mm	jaws 1.5mm	3x4 teeth and serrated platform	5x5 teeth

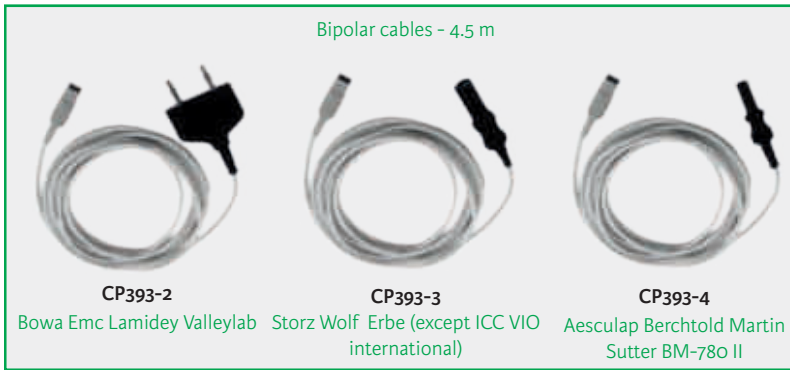

Magnan



Adson



110mm		120mm		160mm		200mm	
CP392-1R	CP604BR	CP605BR	CP392-2R	CP392-8R	CP392BI	CP392BS	
Smooth jaws 1x8mm	Serrated jaws 1.5mm	1x2 teeth 1.5mm	Smooth jaws 1x8mm	Smooth jaws 1x8mm	Smooth jaws 0.5x5mm	Smooth jaws 0.5x5mm	



Adson



110mm

CP390-1
Smooth jaws
1x8mm



120mm

CP604M
Serrated jaws
1.5mm



CP605M
1x2 teeth
1.5mm



160mm

CP390-2
Smooth jaws
1x8mm



CP390-8
1x2 teeth
1x8mm

Halsey

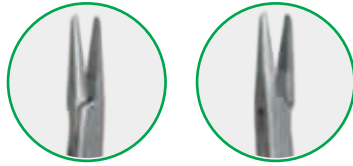

130mm

703T

Serrated jaws

704T

Smooth jaws



703T

Ryder

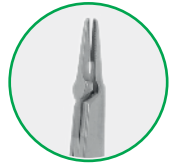

130mm

3744027

Jaws 1mm



Crile-Wood Mayo-Hégar

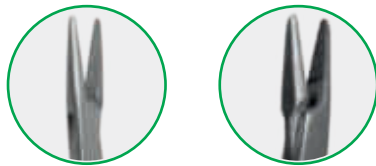

150mm

702T

714T

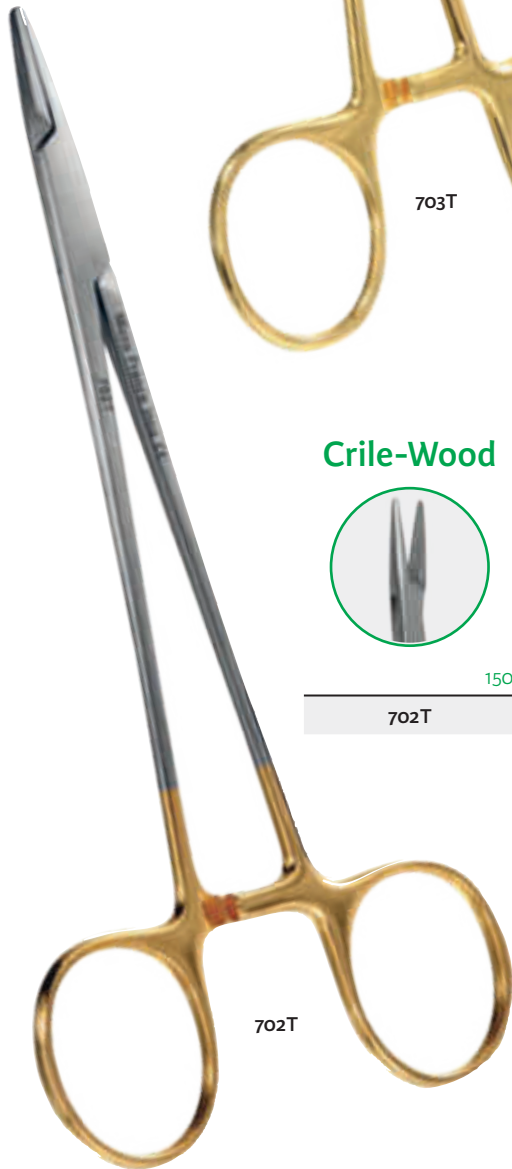

702T

Becker



130mm

CP1107

diamond jaws

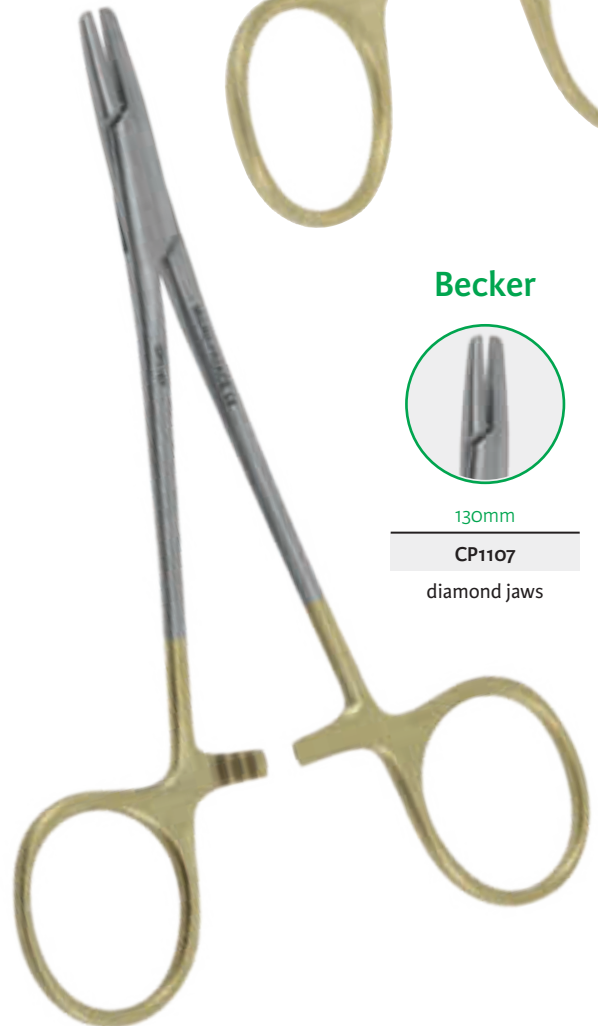

Hartmann-Mosquito

95mm - without teeth

3755111	3755110
curved	straight

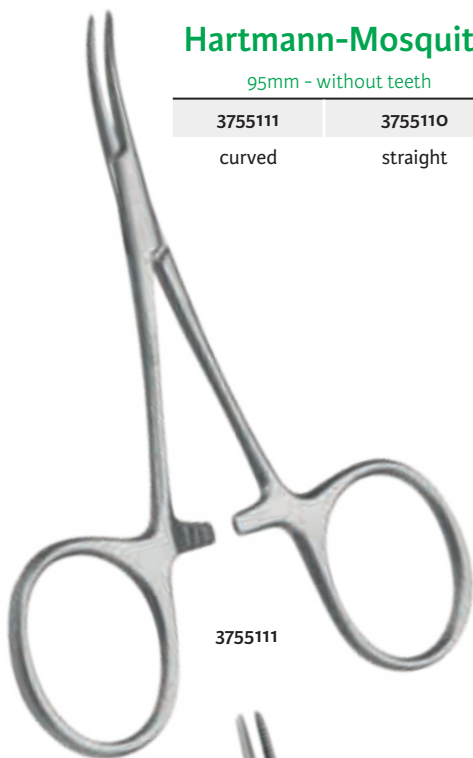

Halsted-Mosquito

120mm - without teeth

3755102	3755101
curved	straight



Mosquito

120mm - without teeth
delicate jaws

3755107	3755106
curved	straight

Leriche

140mm - without teeth

7867-1	7867-2
straight	curved

140mm - with teeth

7867-3	7867-4
straight	curved

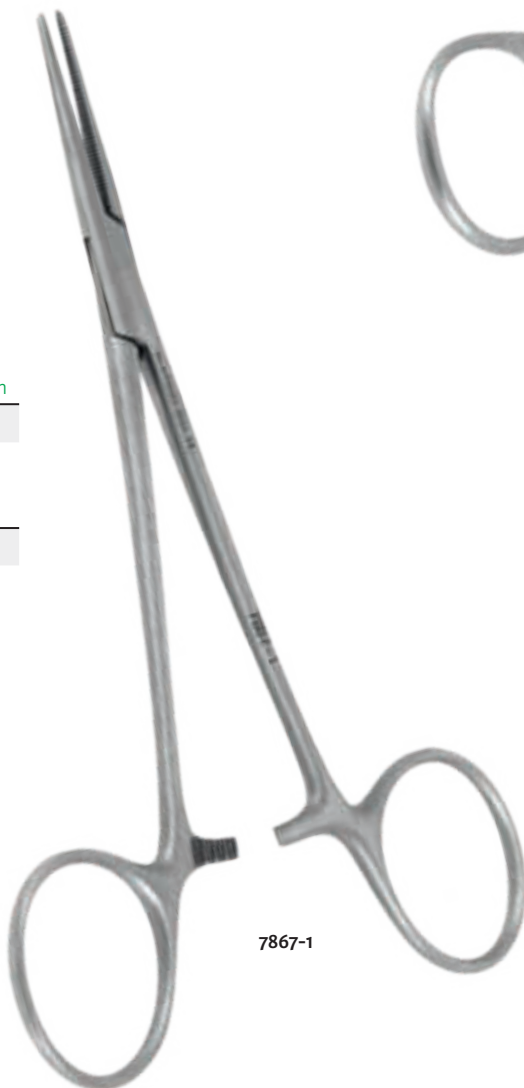

Halsted

120mm - with
teeth

P761-7	P761-8
straight	curved



Crile

140mm - without teeth

3755116	3755117
straight	curved

Kelly

without teeth

	140mm	160mm
3755114	P762-2	P762-4
straight	curved	curved



Rochester-Péan

170mm - without teeth

3755136
curved

Kocher

140mm 160mm 180mm

straight without teeth		
P764-1	P764-5	-
straight with teeth		
P764-3	P764-7	P764-11



130mm

3755010

Towel clamp
serrated jaws



Martel

130mm

P763

Forceps with teeth
'T' tip

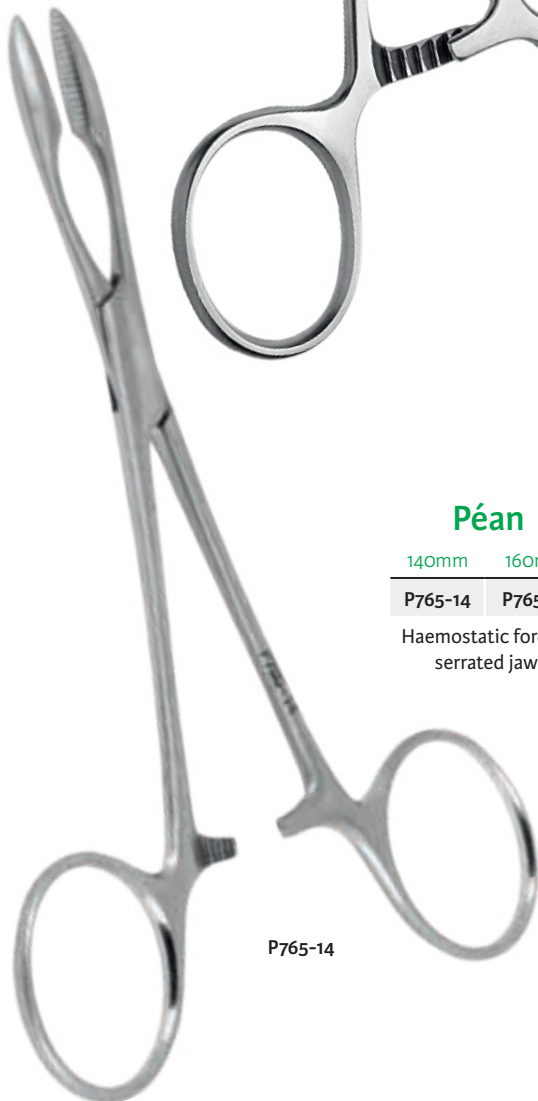

Péan

140mm 160mm

P765-14 P765-16

Haemostatic forceps
serrated jaws

P765-14



Terrier

130mm

P769

Haemostatic forceps
serrated jaws



Backauss

90mm	120mm
3755000	3755001

Towel clamp

3755000



Allis

140mm	150mm
3755160	3755161
3x4 teeth	4x5 teeth

3755161



Chaput

130mm
7866-13
2x3 teeth

2x3 teeth

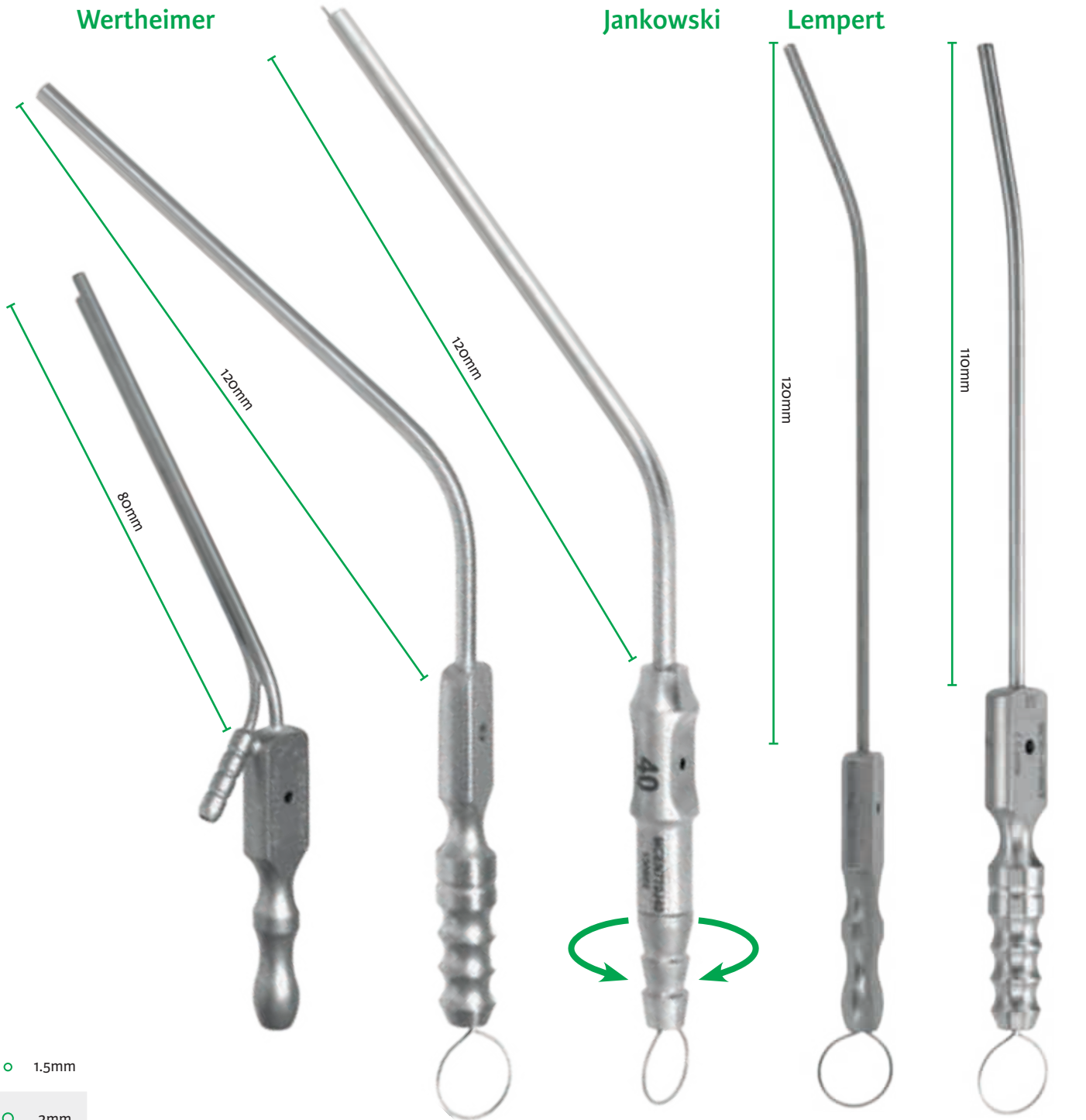

- 1.5mm
- 2mm
- 2.5mm
- 3mm
- 3.5mm
- 4mm

Wertheimer		Jankowski		Lempert	
MCO201-2-5	2.5mm	MCEN770J40	4mm	MCO771-2-5	2.5mm
MCO201-3-0	3mm	MCEN770J30	3mm	MCO771-3-0	3mm
MCO770-1-5	1.5mm			MCO771-4-0	4mm
MCO770-2-0	2mm				
MCO770-2-5	2.5mm				
MCO770-3-0	3mm				
MCO770-3-5	3.5mm				
MCO770-4-0	4mm				
				CP330-3-0	3mm
				CP330-4-0	4mm

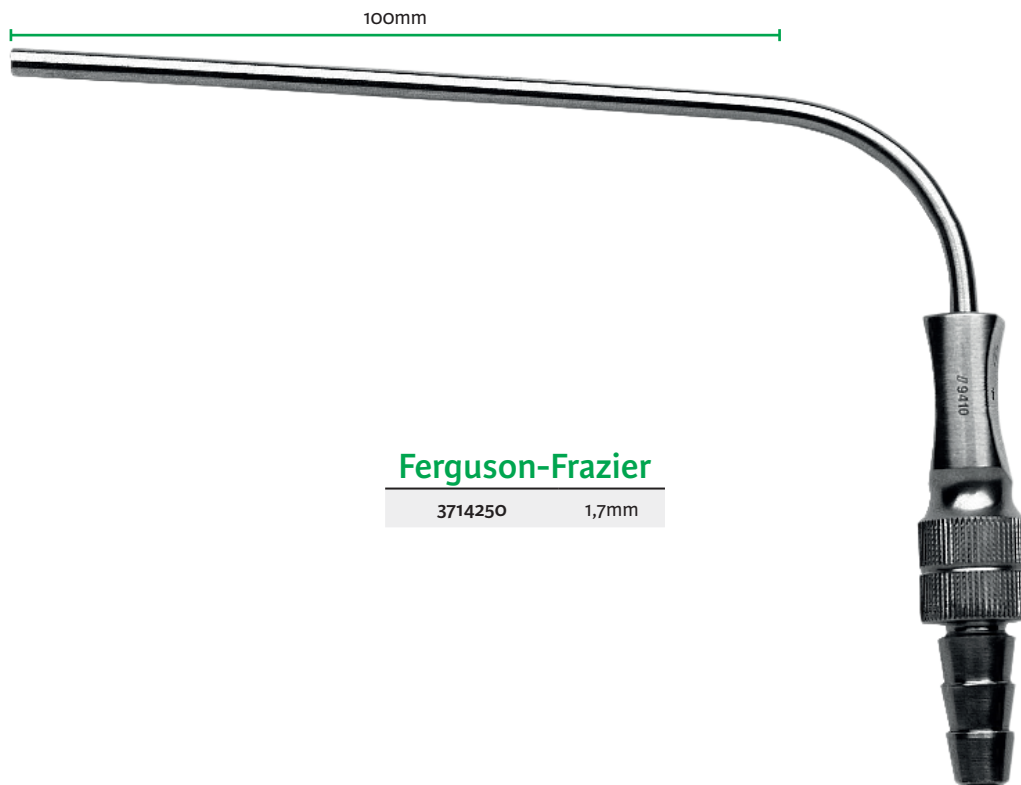

Ferguson-Frazier

3714250	1,7mm
---------	-------

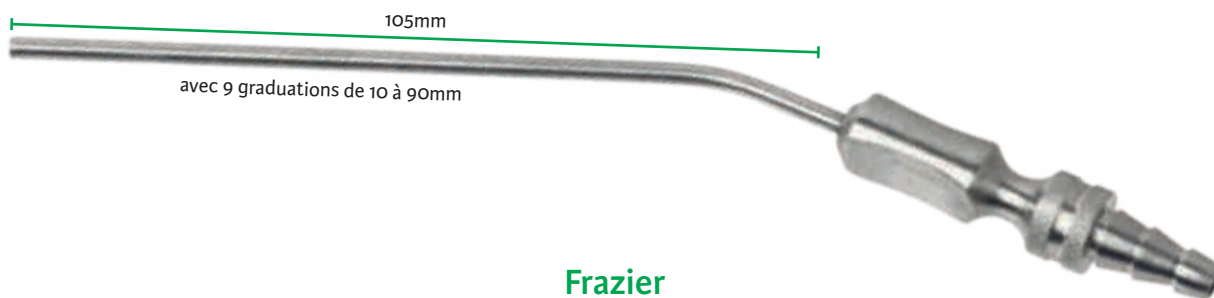

Frazier

3714001	2,3mm
3714002	2,7mm
3714003	3mm
3714004	3,3mm
3714006	4mm

delivered with stylette

3714004

Luer-lock adapter

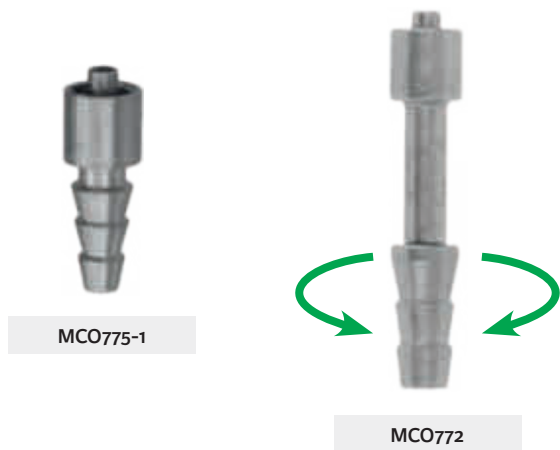

Suction tube adapter with finger control



Benzeth



Micro curved suction tube

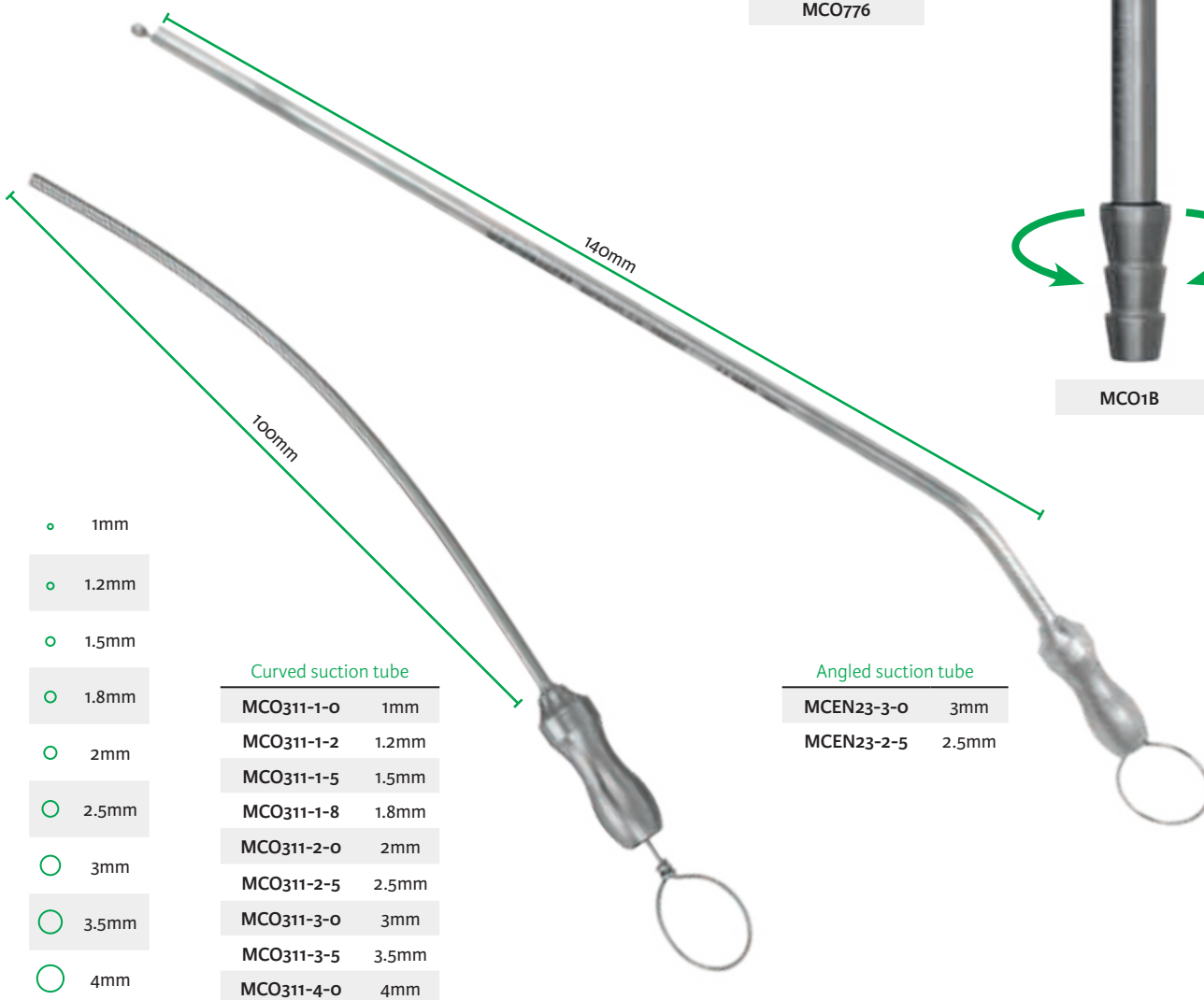

- 1mm
- 1.2mm
- 1.5mm
- 1.8mm
- 2mm
- 2.5mm
- 3mm
- 3.5mm
- 4mm

Curved suction tube

MCO311-1-0	1mm
MCO311-1-2	1.2mm
MCO311-1-5	1.5mm
MCO311-1-8	1.8mm
MCO311-2-0	2mm
MCO311-2-5	2.5mm
MCO311-3-0	3mm
MCO311-3-5	3.5mm
MCO311-4-0	4mm

Angled suction tube

MCEN23-3-0	3mm
MCEN23-2-5	2.5mm

Maspetiol

Charachon

Bellucci

Mac-Gee



MCO773

Micro suction tube Ø 2,5 mm

MCO773

with luer-lock connection

Micro suction tube tip
for MCO773

MCO774-0-4	0,4mm
MCO774-0-5	0,5mm
MCO774-0-6	0,6mm
MCO774D8	0,8mm



MCO890

Micro suction tube Ø 3mm

MCO890

Micro suction tube tip

MCO890-1-04	0,4mm
MCO890-1-08	0,8mm
MCO890-1-10	1mm
MCO890-1-12	1,2mm
MCO890-1-15	1,5mm
MCO890-1-20	2mm



Micro curved suction tube

3724196



3724420

Micro curved suction tube

3724420	0,7mm
3724421	0,5mm
3724422	0,4mm

Baron

Schucknecht

House



3724175

Micro curved suction tube with finger control

3724172	1mm
3724173	1,7mm
3724175	2,3mm



3724211

Micro suction tube with finger control

3724210	0,7mm
3724211	0,5mm



3724218

Micro suction irrigation tube with finger control

3724218	0,8/1,3mm
3724220	1,4/1,7mm

Rosen

Frayse

Cause

Guilford-Wright

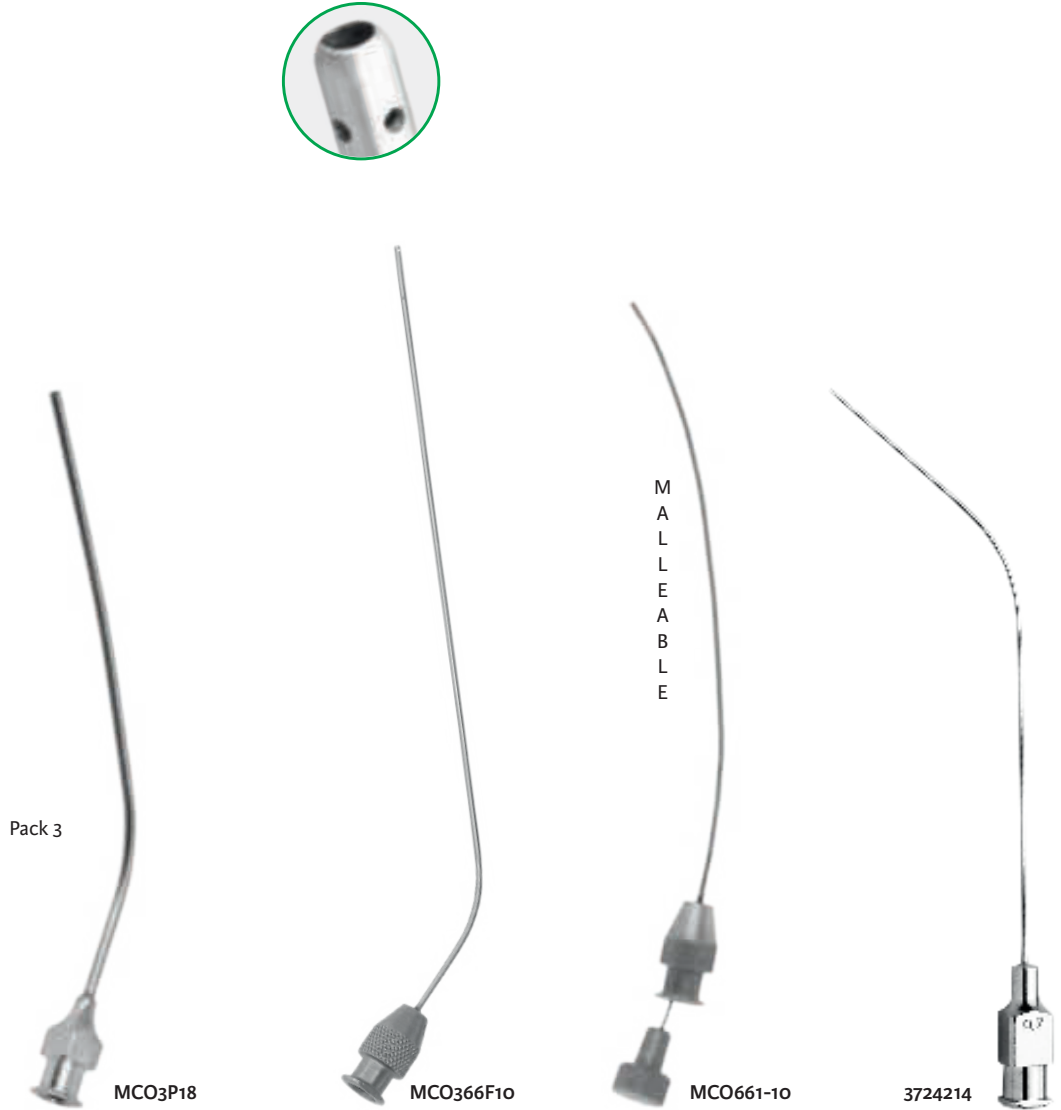

Suction tube adapter with finger control			
Sterile - Pack 10 - disposable			
1358270			
Micro malleable suction tube for 1358270			
Sterile - Pack 10 - disposable			
1359254	red	2.1mm	
1359256	yellow	1.6mm	
1359258	black	1.3mm	
1359260	green	0.9mm	
1359262	clear	0.7mm	
1359264	blue	0.5mm	











Micro angled suction tube with luer-lock		
Pack 3		
MCO3P05	0.5mm	
MCO3P07	0.7mm	
MCO3P10	1mm	
MCO3P12	1.2mm	
MCO3P15	1.5mm	
MCO3P18	1.8mm	
MCO3P20	2mm	
MCO3P24	2.4mm	

Micro blunt eyes suction tube with luer-lock		
MCO366F10	1mm	
MCO366F12	1.2mm	
MCO366F15	1.5mm	
MCO366F20	2mm	

Micro malleable suction tube with luer-lock		
MCO661-10	1mm	
MCO661-7	0.7mm	

Micro angled suction tube with luer-lock		
3724214	0.7mm	

Hartmann

	MCO13C 0.6x3mm				
	MCO13A 4.5x1mm		MCO17 4x0.8mm Right opening		MCO960 0.6x3mm
	MCO13D 6x1.3mm		MCO22 6x1.5mm 1x2 teeth		MCO961 0.6x3mm
	MCO13B 8x1.6mm		MCO219C Right opening, upward		
	MCO13E 0.9x12mm		MCO24 Crocodile		

70mm

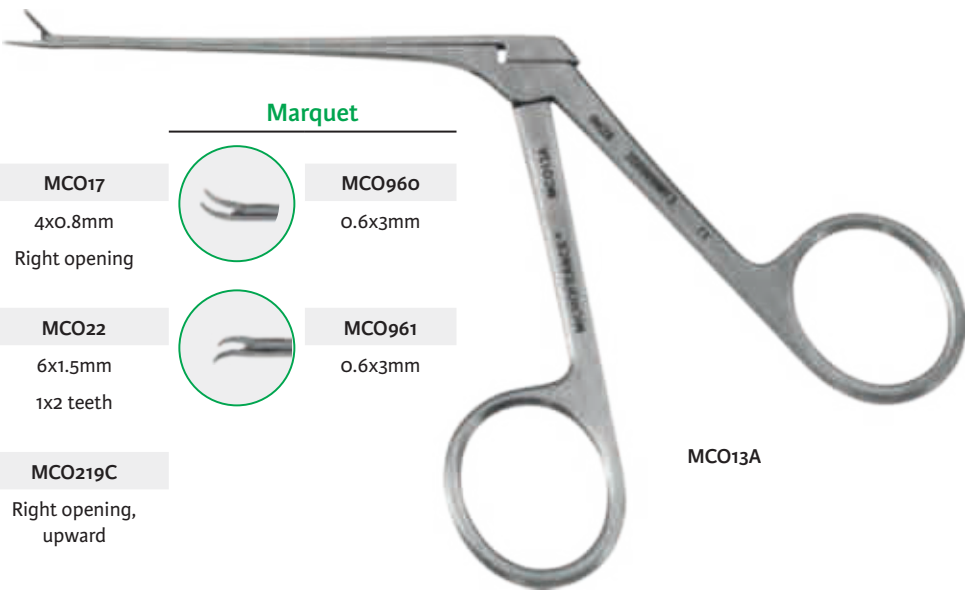

MCO13A

Marquet



Alligator forceps

100mm

Martin

	MCO23A 1.5x8mm	
--	--------------------------	--

80mm

	MCO23 6x1mm	
	MCO23B 6x1mm Right opening	

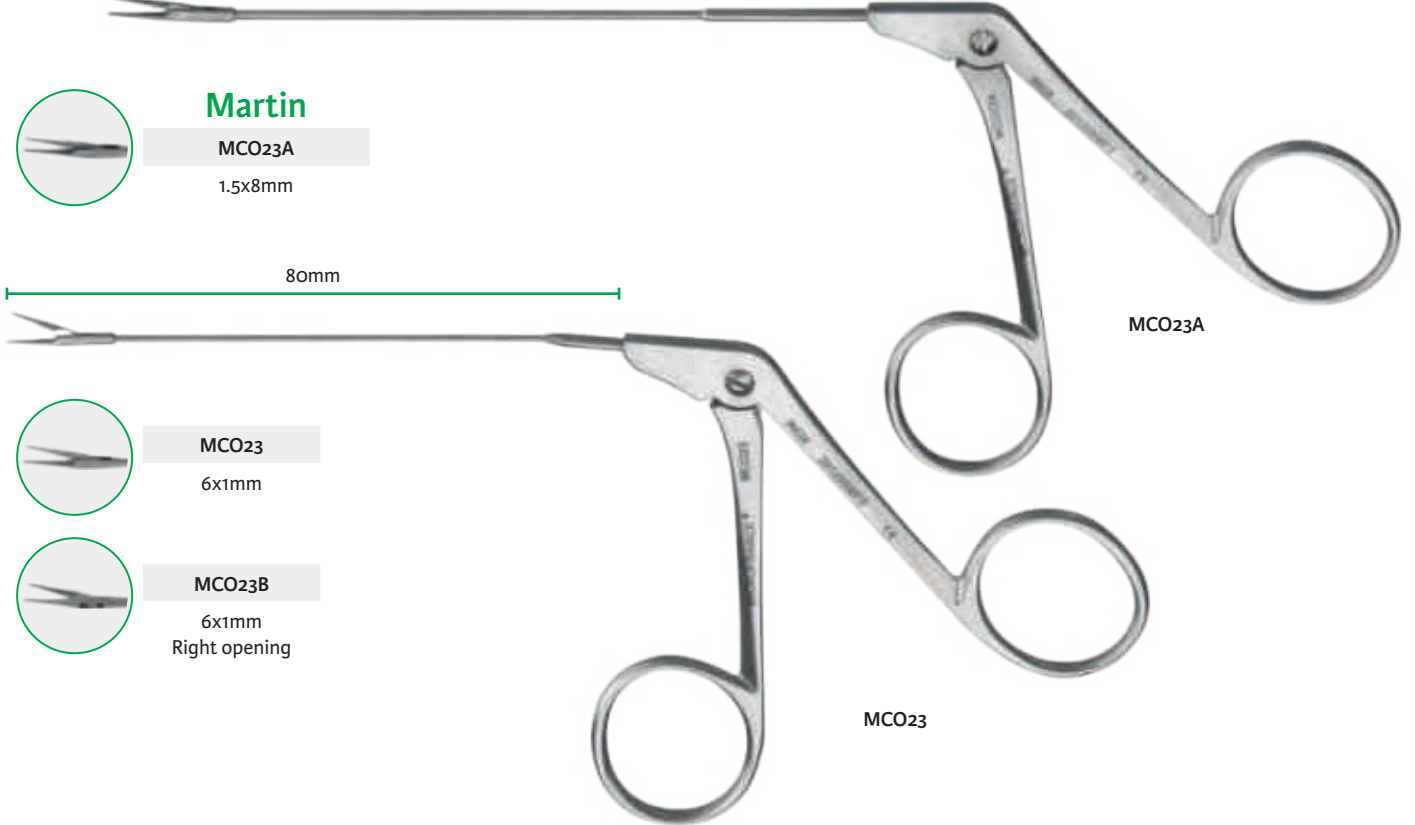

MCO23A

MCO23

Scale 1/2

House

3721026	3721027
4.5mm	3mm



3721036	3721025	3721030
4mm	6mm	4mm angled up

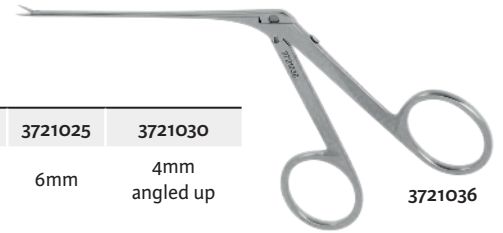

Belluci

3721014
8mm



House

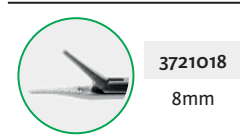

Noyes

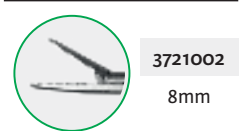

Duckbill

3721004
6mm



Panther

Black finish	
3721024	3721023
4mm	3mm



Greven

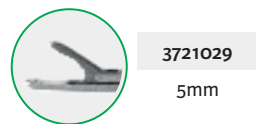

House-Strut

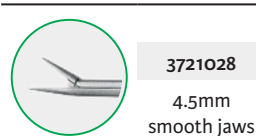
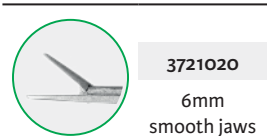

Micro scissors

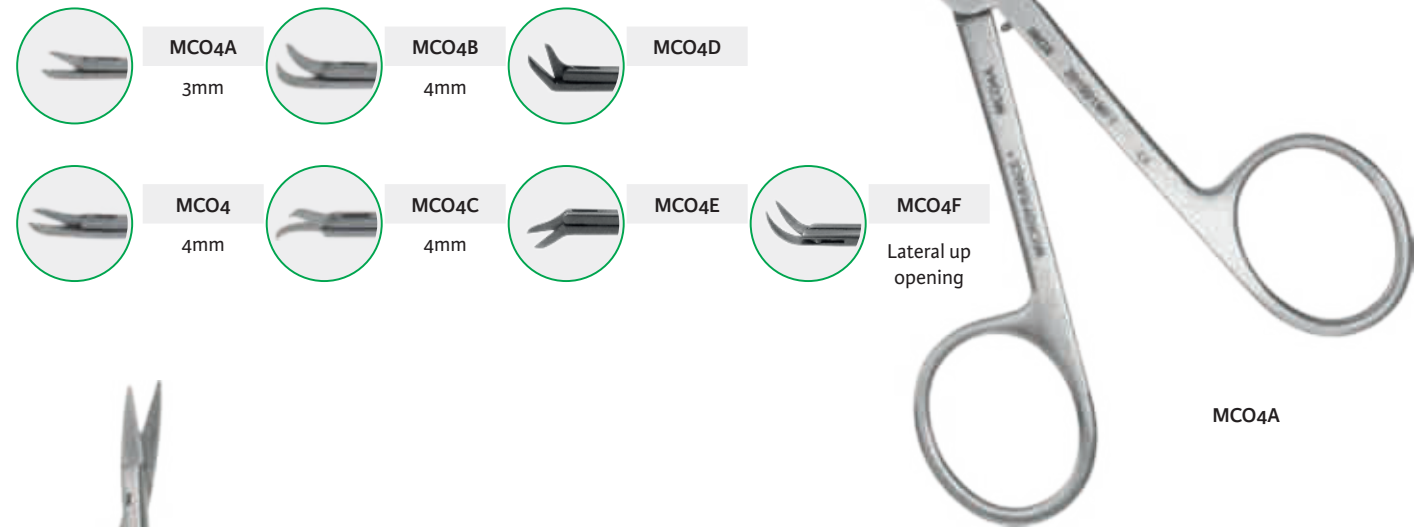

Micro cup forceps

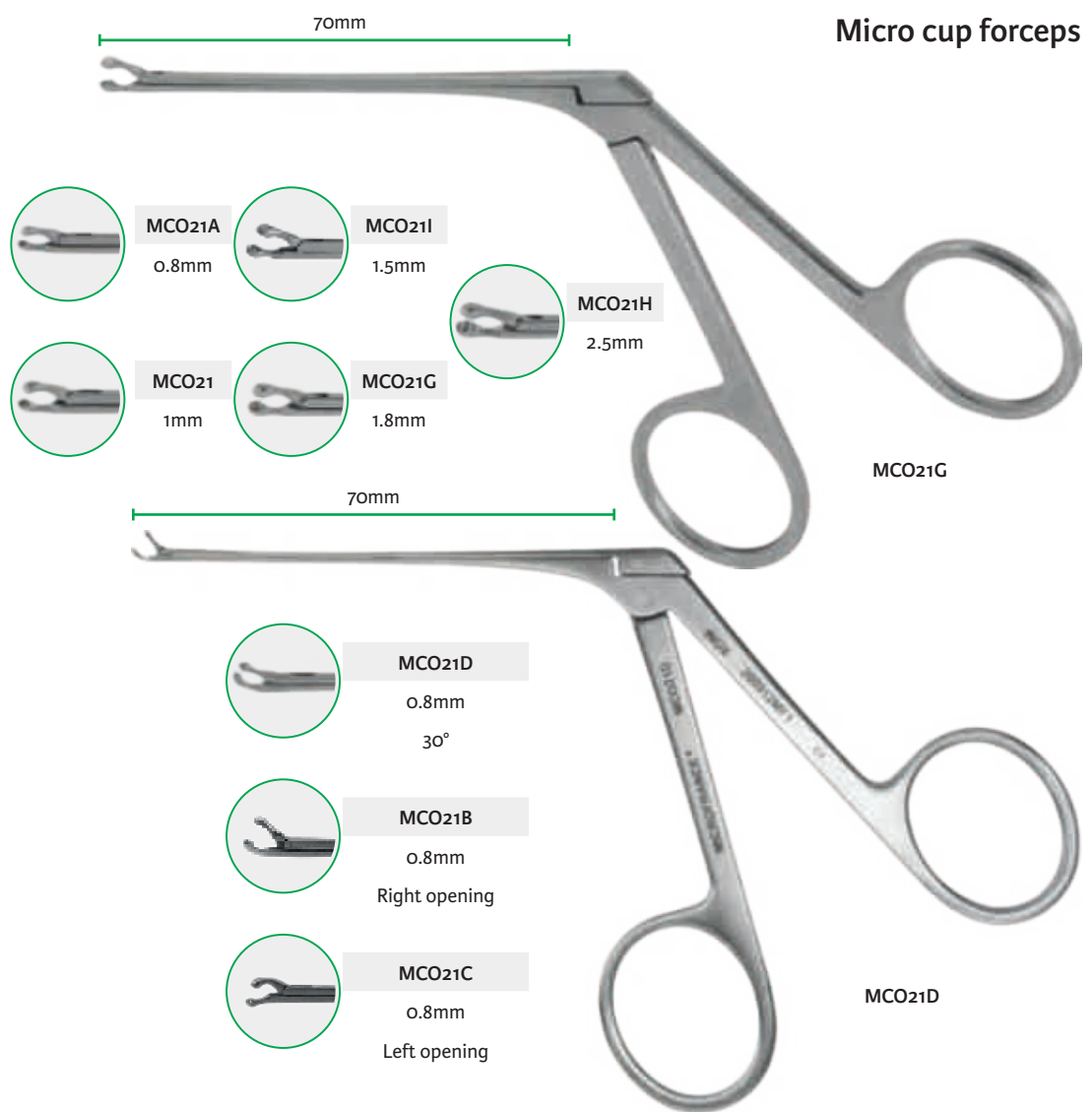

Micro scissors

Scale 1/2

House-Bellucci

blades 5mm



- 3724083 straight
- 3724084 left curved
- 3724085 right curved
- 3724311 angled up 60°



3724083

Bellucci



- 3723001 straight 8mm
- 3723008 straight 4.5mm
- 3724309 left curved 8mm
- 3724310 right curved 8 mm

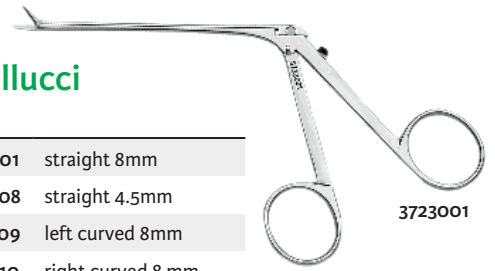

3723001

Panther



- Black finish
- 3724312
- straight blades
- 3mm



3724312

Fisch



- Crura delicate scissors
- lateral opening
- 3723005 left
- 3723006 right



3723006

Micro cup forceps

Hartman-Herzfeld



- 3721006 Ø 3mm
- 3724266 Ø 2mm
- 3721007 upward
- Ø 2mm



3721006

House



- angled 25° Ø 0.9mm
- 3721021 right
- 3721022 left



3721021



- 3721032
- 0.9x2mm



- 3721041
- Ø 0.75mm



House-Wullstein



- 0.6x1.2mm
- 3721037
- 3721038 left
- 3721039 right
- 3721040 angled up 55°



3721037

Kraus

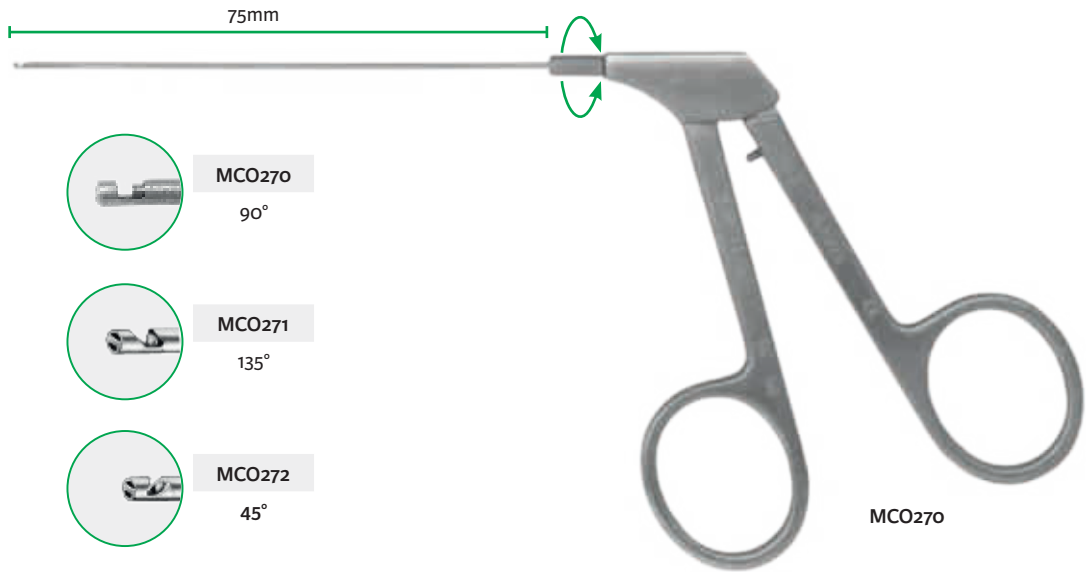

Dieter

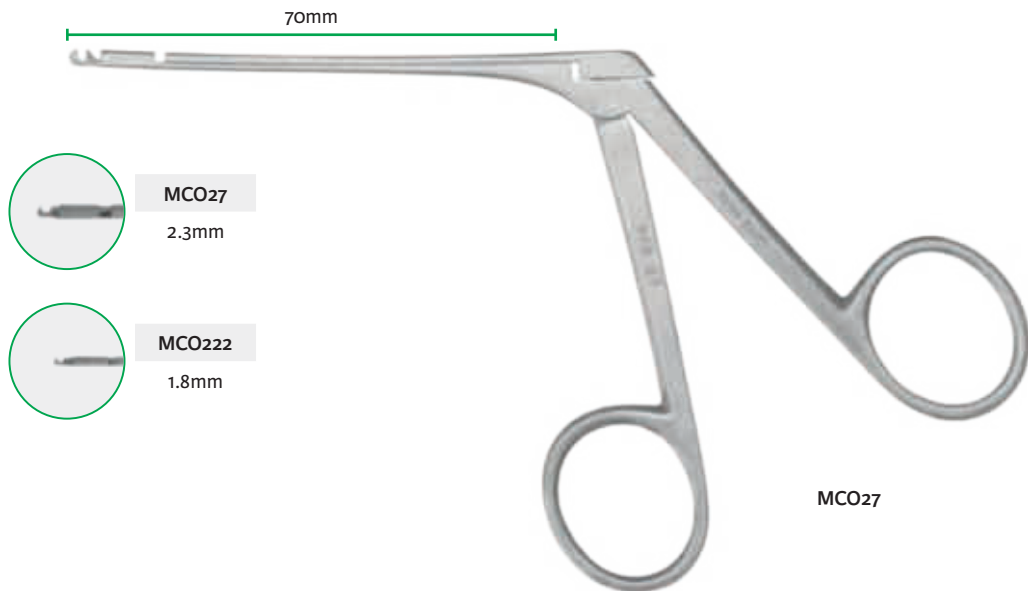

Dieter-Charachon



House-Dieters

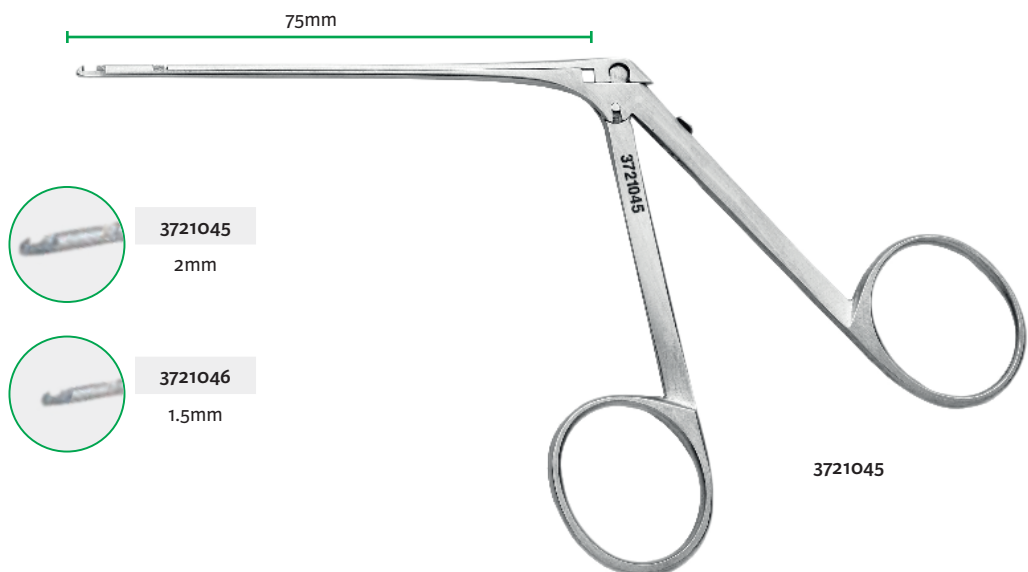

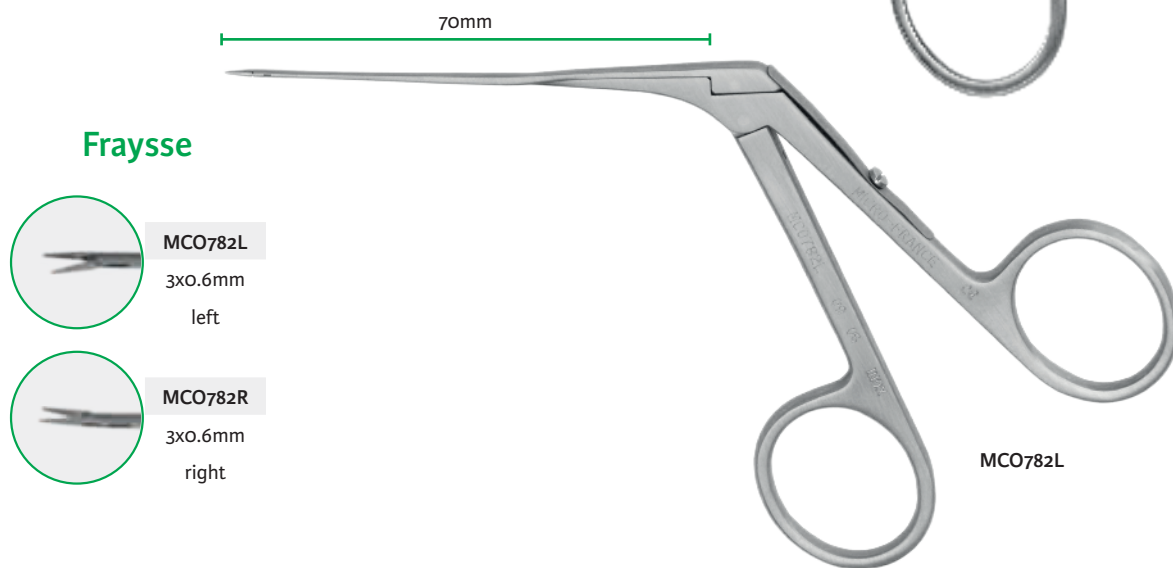
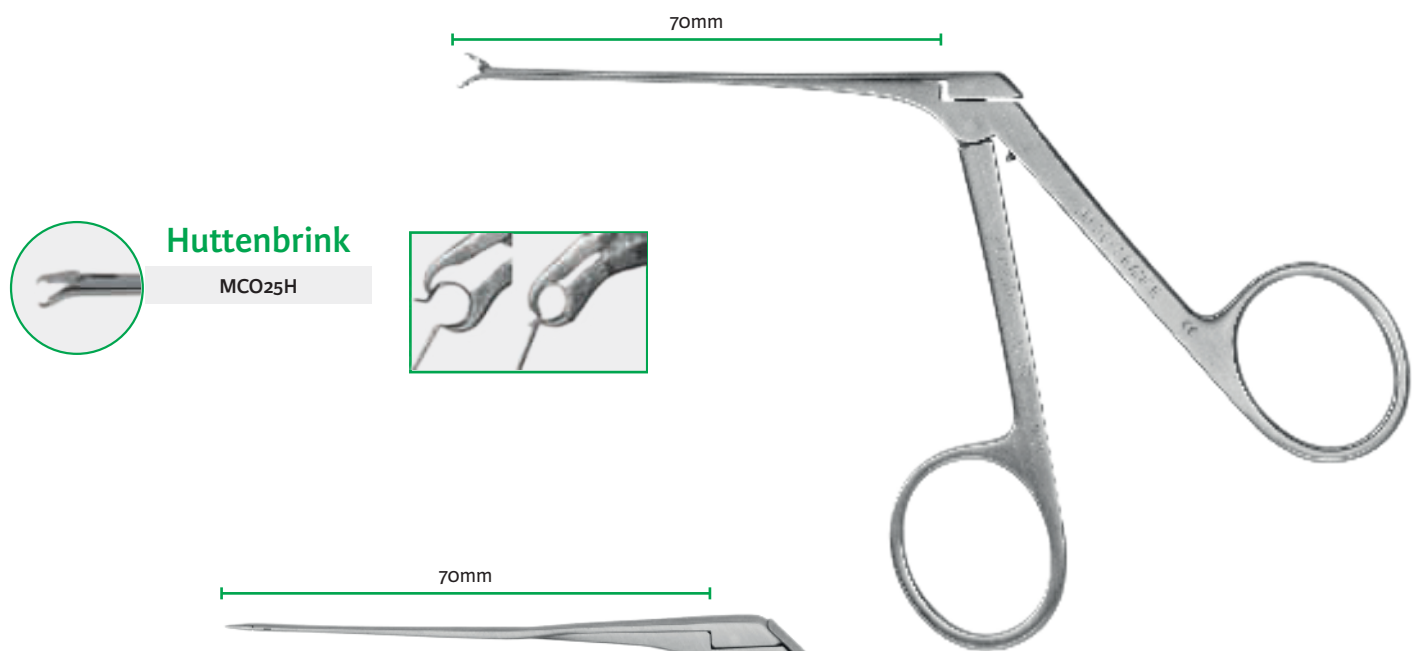
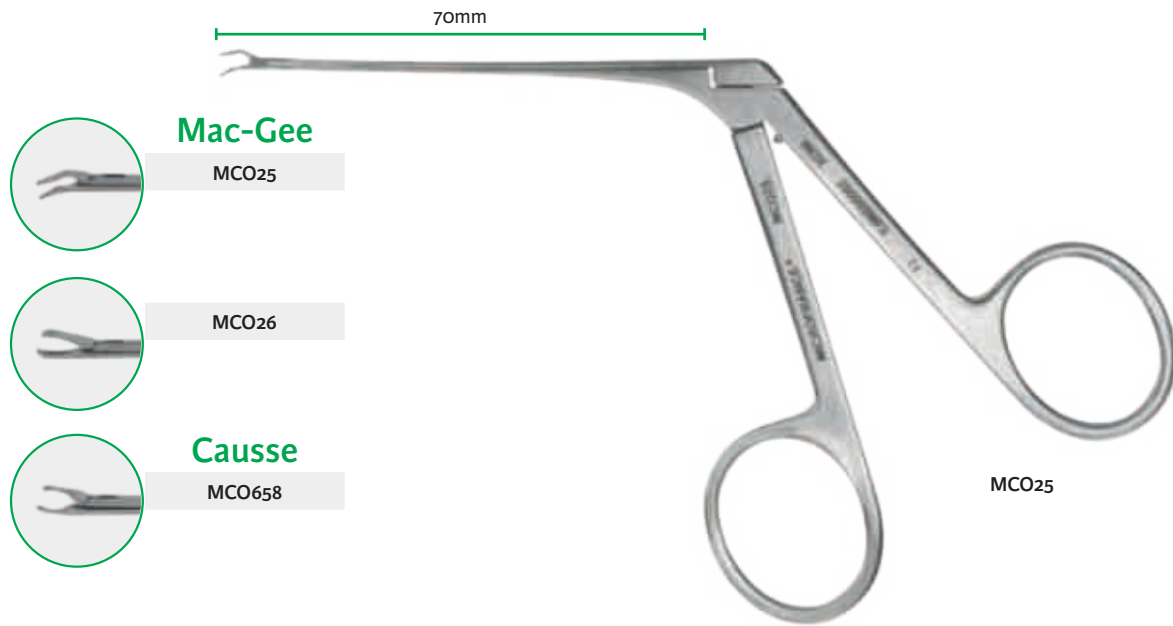

Scale 2/3

Mac-Gee



- 3721008 down jaws 3mm
- 3721009 straight jaws 3mm

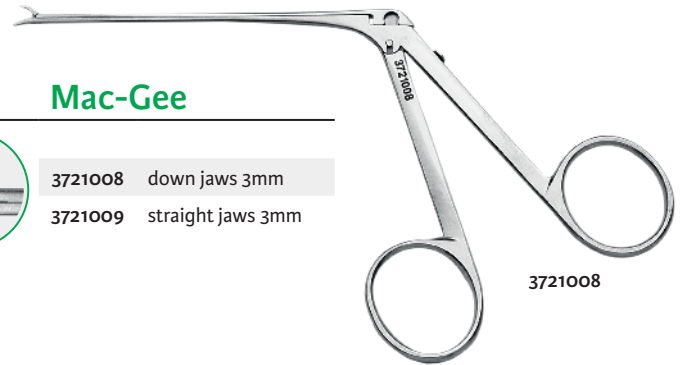

3721008

Schucknecht



- 3721015 jaws 6 mm



Juers



- 3724269 serrated left
- 3724370 serrated right

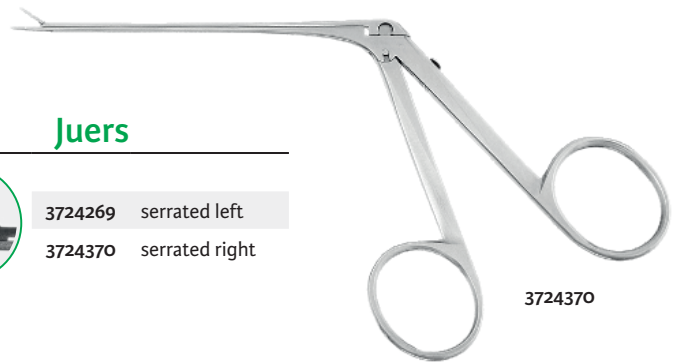

3724370

Hough



Nipper forceps 45°

- 3721012 right
- 3721013 left

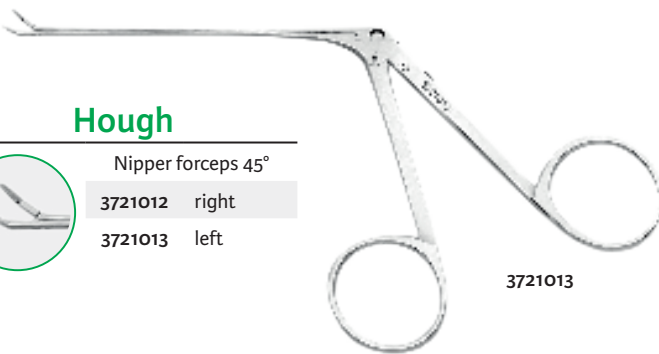

3721013

Kos



- 3721016 jaws 3.5mm





MCO5A-2-5
165mm



Micro knife 45°

Oval knife

Cause

Martin

45°

Rosen

Cause

Plester

MCO5A-2-5	2.5mm	MCO652	MCO215	MCO5C	MCO313	MCO653	MCO6
MCO5A-1-0	1mm	3mm	3mm	2.5mm	1.8x2.5mm	1.5x2mm	2x2.5mm
MCO5A-1-5	1.5mm		knife mirror	angled tip			
MCO5A-2-0	2mm						

Micro sickle knife

Micro lancet knife

Knife

Micro straight chisel

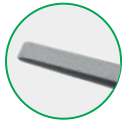

Rosen

Morgon

Jost

MCO10	MCO10B	MCO10M	MCO204C	MCO204B	MCO317	MCO2
5mm	4.5mm	4mm	2x4mm	1.5x2mm	2.3mm	1.2mm



MCO650
165mm



Tip bent shaft

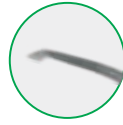

Cause

Frayse

Cause

Plester

MCO5B	MCO650	MCO5	MCO651F	MCO651	MCO6C
30° 2.5mm	90° 3mm	90° 2.5mm	90° 1.5x1.5mm	45° 1.5x2mm	30° 2x2.5mm

Micro knife

Micro lancet knife

Micro oval knife



MCO5E
165mm

→ Suction



MCO5D
45°
2mm

Micro suction round knife



MCO5E
45°
3mm

Josephson



160mm



Sickle knife
3mm

MCO312
Double instrument

Micro knife
45°
1.5x3mm



Micro mirror



Micro raspatory

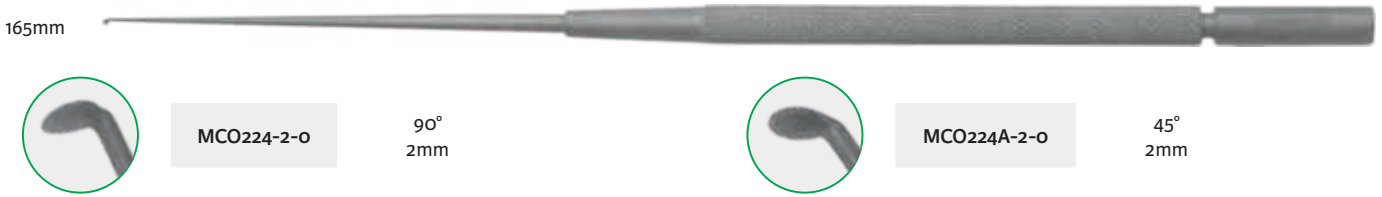

Micro angled elevator

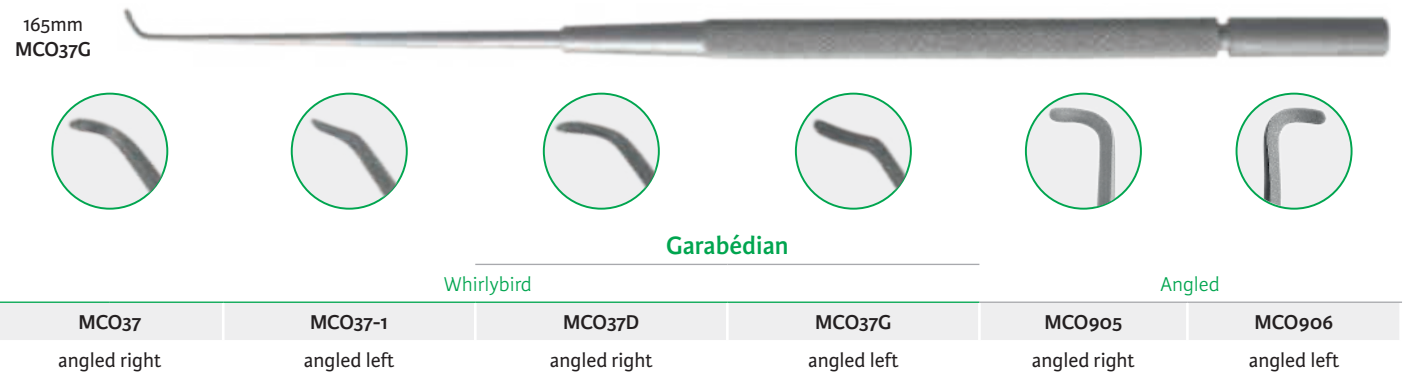

Micro curved elevator

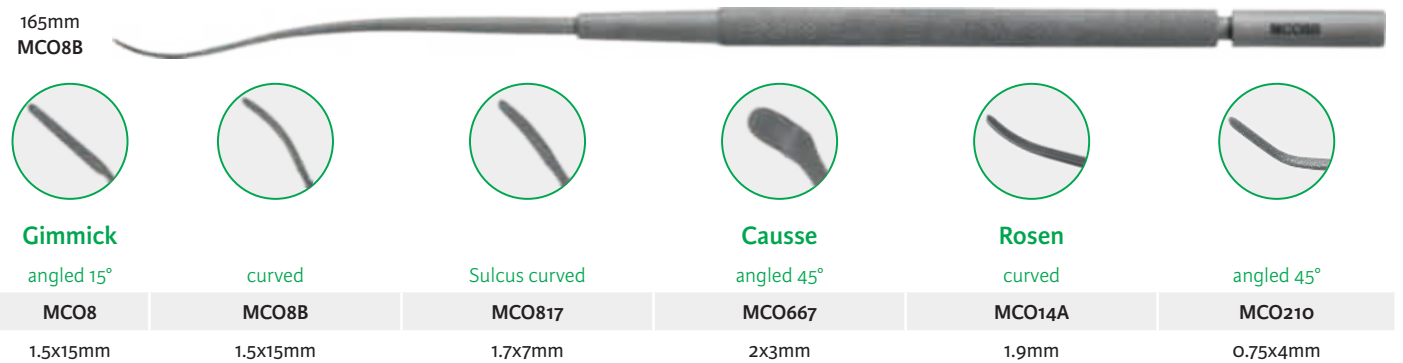

Micro double elevator

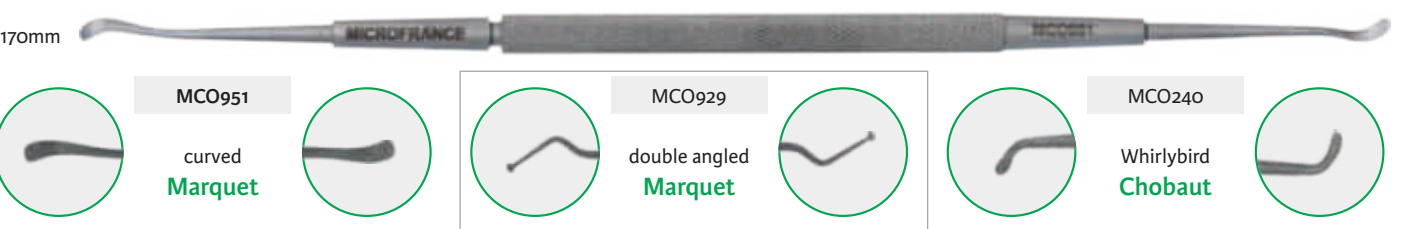

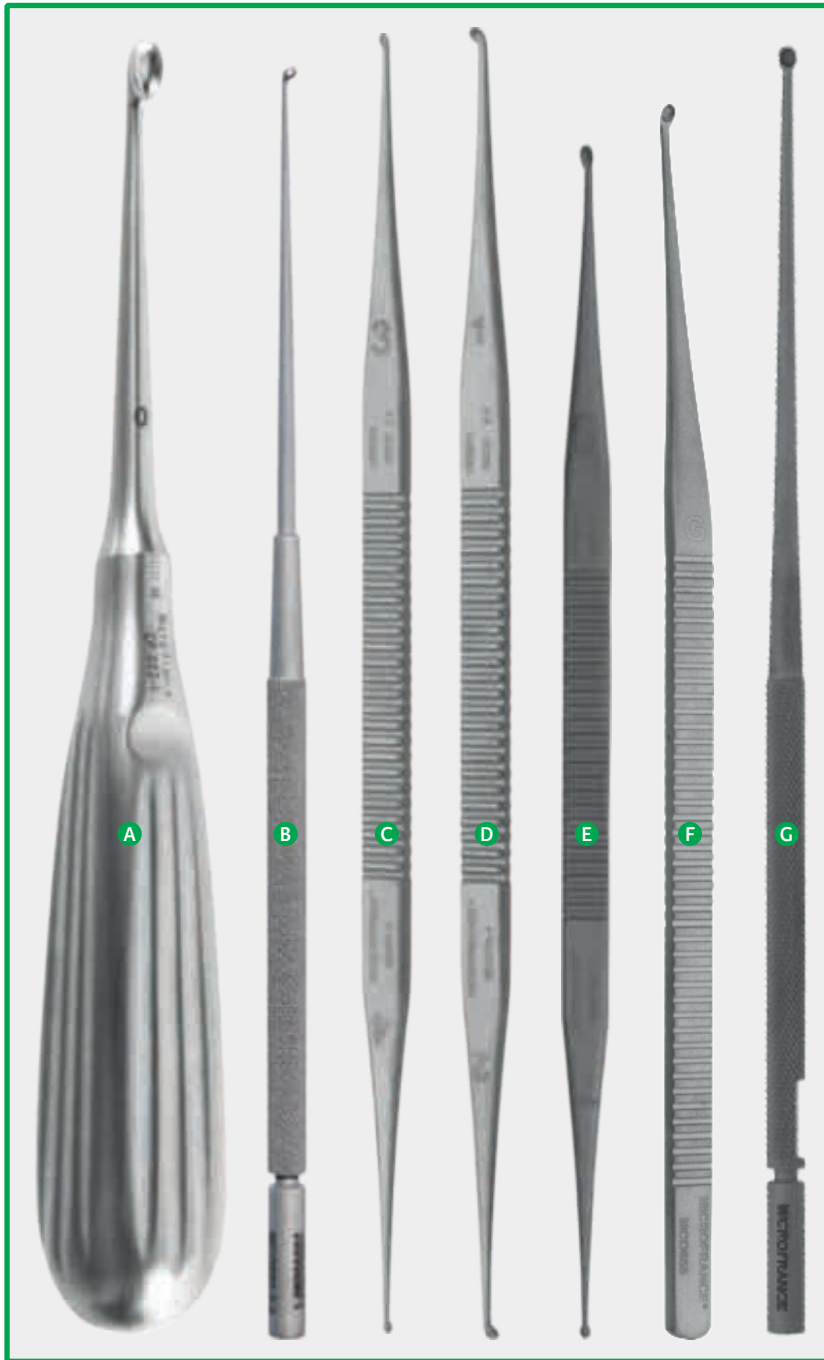

A

Volkmann straight curette 170mm

0	CP302-2	2mm
○	CP302-3	3mm
○	CP302-4	4mm
○	CP302-5	5mm
○	CP302-6	6mm
○	CP302-8	8mm

B

Micro fenestrated curette 165mm

	MCO207-1-5	1,5mm
	MCO207-2-0	2mm

C

Micro straight double curette 170mm

	MCO7-1	2,2 / 2,5mm n° 1/2
	MCO7-3	1,5 / 1,9mm n° 3/4

D

Micro angled double curette 155mm

	MCO7A-1	2,2 / 2,5mm n° 1/2
	MCO7A-3	1,5 / 1,9mm n° 3/4
	MCO7A-5	1 / 1,2mm n° 5/6

G

Micro straight curette 170mm

	MCO818	2,5mm
--	--------	-------

A

B

C

D

E

F

G

E

Micro double curette 155mm

Romanet

	MCO7A6	angled 1,7x3,2 / 1,3x2,3mm
--	--------	----------------------------------

F

Micro angled curette 160mm

Causse

	MCO655	2,8mm 45°
--	--------	-----------

Micro pick

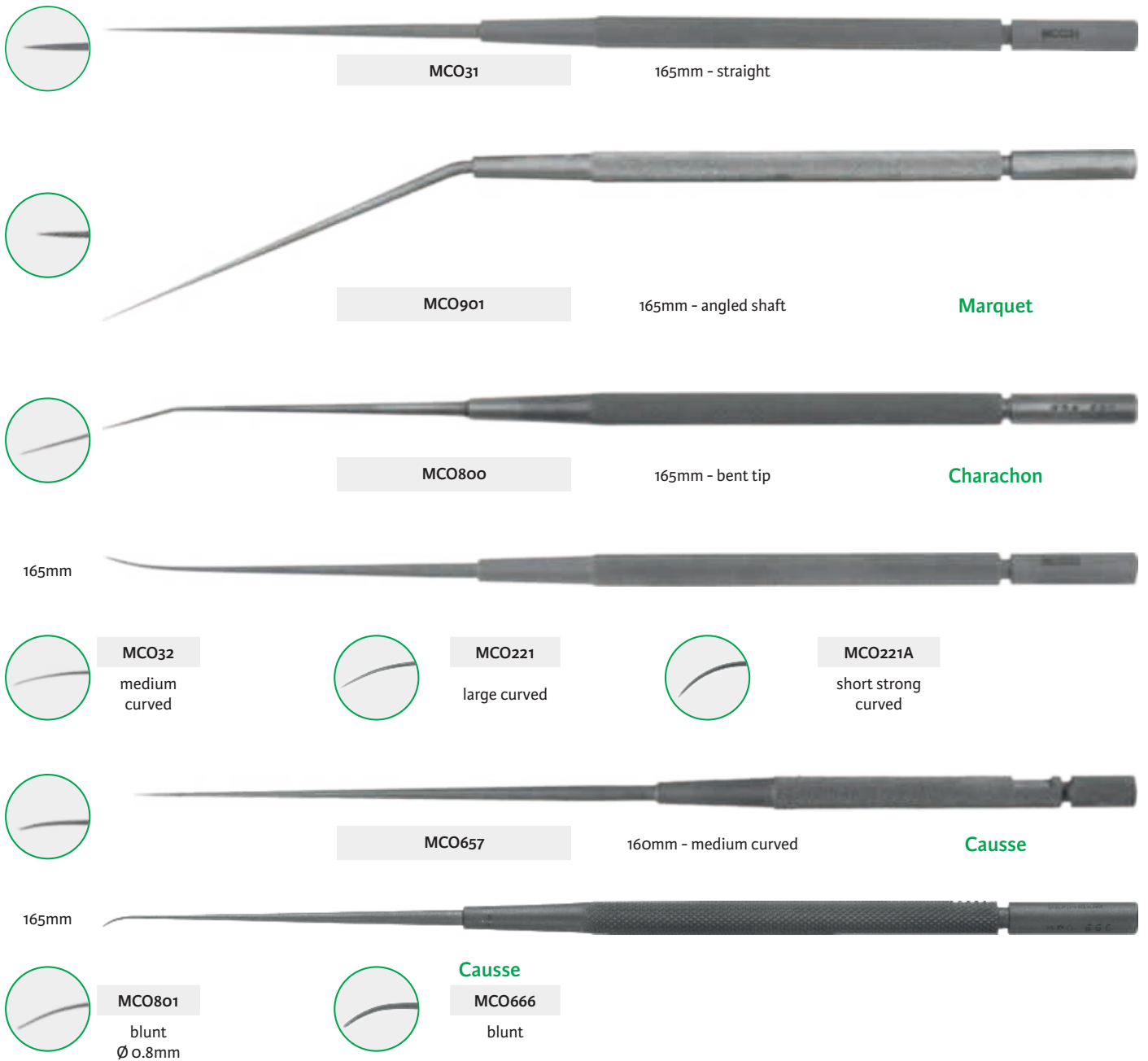



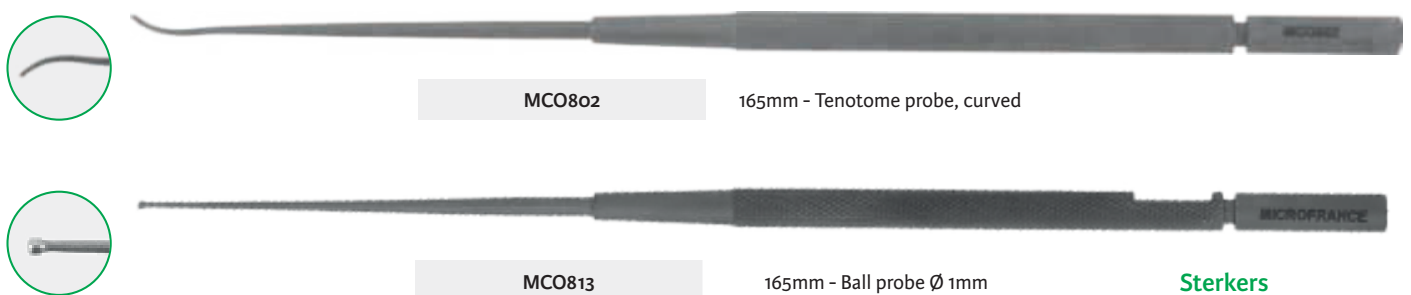









Tenotome probe - Ball probe



Micro hook, straight shaft

165mm
MCO6A











									
45°	MCO6A	MCO806	MCO807						
	0.7mm	Charachon 2mm	Legent 1mm		Marquet	Causse	Causse	Causse	
									
90°	MCO205	MCO6B	MCO806A	MCO806B	MCO950	MCO654-1	MCO654-2	MCO841	
	0.3mm	0.7mm	2mm	4mm	0.8mm	1.2mm -right	1.2mm - left		

Micro hook, angled shaft

165mm



				Posterior	Anterior	Right	Left
	Marquet		90° 0.2mm	MCO916	MCO915		
	Charachon		90° 0.2mm consolidated shaft	MCO832A	MCO832B	MCO832C	MCO832D
	Charachon		90° 0.2mm fine shaft			MCO833C	MCO833D
			90° 0.3mm	MCO205A	MCO205B	MCO205C	MCO205D
	Causse		0.2mm	MCO663-2	MCO663-1		
	Causse		0.4mm	MCO662-2	MCO662-1		
	Causse		90° 0.4mm		MCO664		
	Causse		90° 0.7mm		MCO665		
	Marquet		45° 0.9mm		MCO920		

Micro hook, tip bent shaft

165mm



		90° 0.5mm	MCO226A	MCO226	MCO226B	MCO226C
Poncet			Posterior	Anterior	Right	Left

Micro joint knife

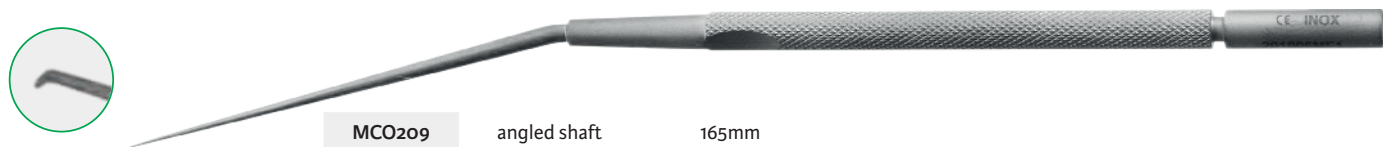

MCO209 angled shaft 165mm



MCO656 incudostapedial 45°

Cause

Micro raspatory

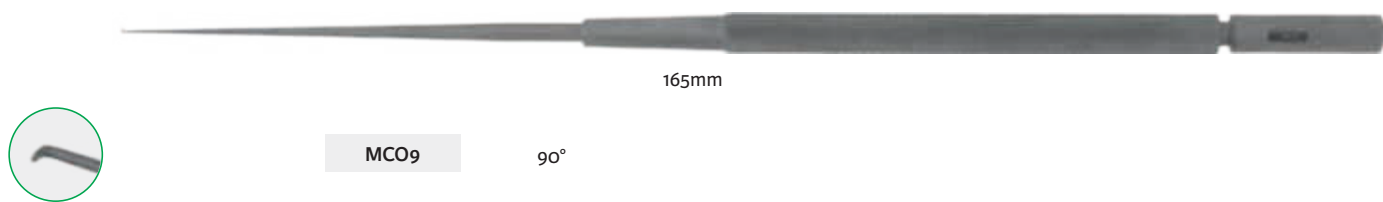

MCO9 90°

Micro hook - Micro raspatory



MCO9-1 Raspatory curved 90°

Thomassin



MCO804 Hook curved 90° 0.7mm tip bent shaft

Thomassin

Micro instrument, spoon handle

Portmann

Micro straight pick

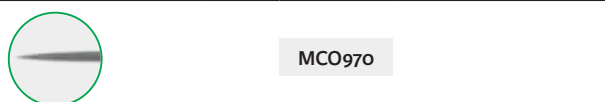

MCO970

Micro hook 90°

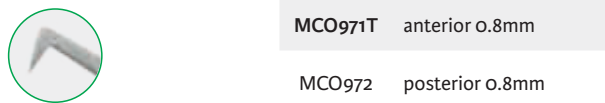

MCO971T anterior 0.8mm

MCO972 posterior 0.8mm

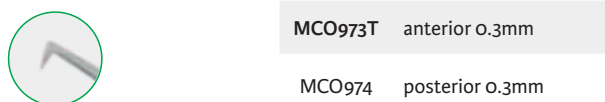

MCO973T anterior 0.3mm

MCO974 posterior 0.3mm

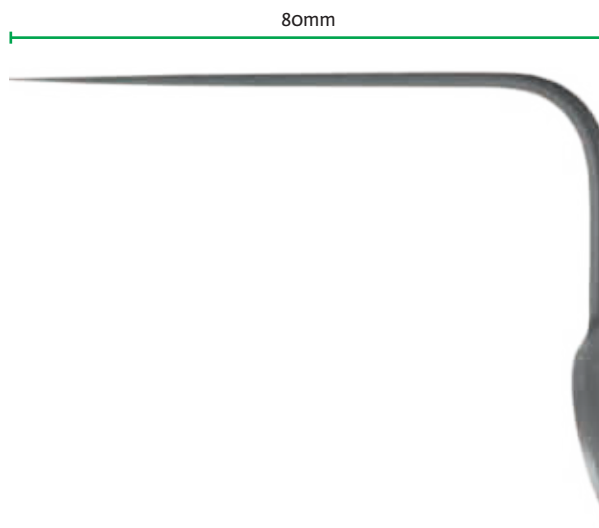

Monopolar curved elevator



MCO8BM

Bordure

140mm

Curved monopolar pick, blunt

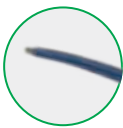

MCO989

Legent

180mm

Monopolar cables - 3.5 m

 CP391E Erbe ACC ICC/VIO Storz Wolf	 CP391M Aesculap Berchtold Lamidey Martin Erbe T Serie Sutter BM-780 II	 CP391V Bowa Bovie Conmed Valleylab
---	---	--

Bipolar forceps

Scale 1/4

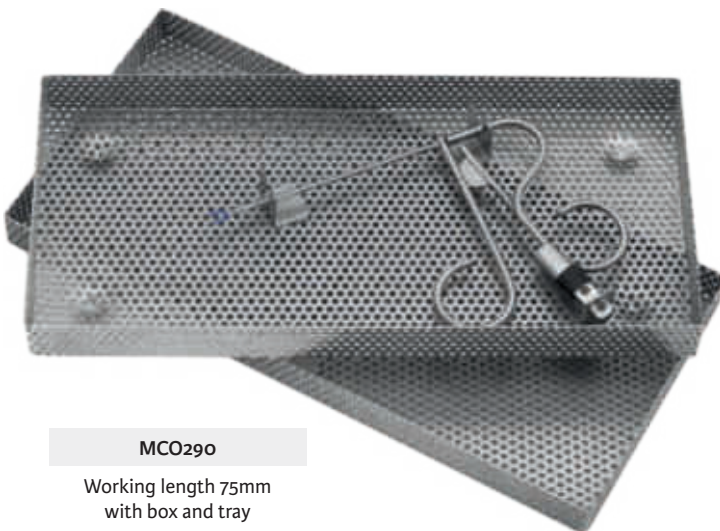

MCO290

Working length 75mm
with box and tray

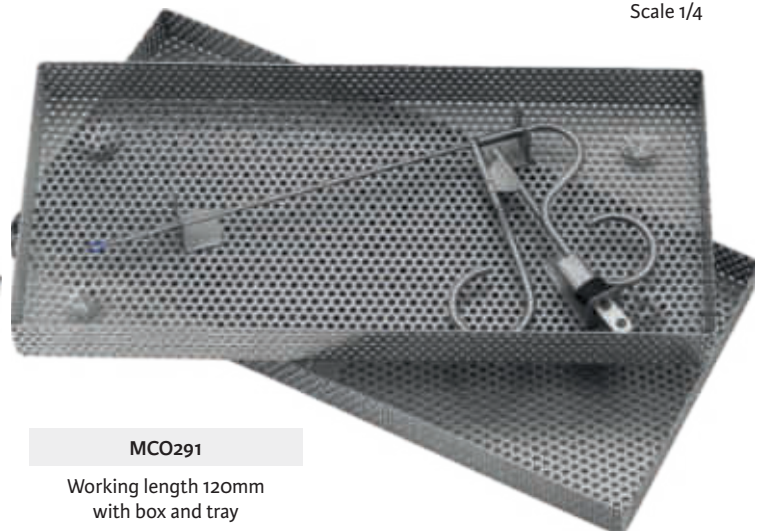

MCO291

Working length 120mm
with box and tray

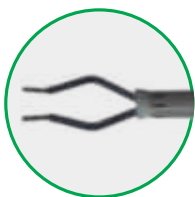

Bipolar cables - 4.5 m

 CP393-2 Bowa Emc Lamidey Valleylab	 CP393-3 Storz Wolf Erbe (except ICC VIO international)	 CP393-4 Aesculap Berchtold Martin Sutter BM-780 II
---	---	--

Micro measuring rod, angled shaft

165mm
MCO12B

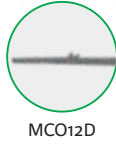
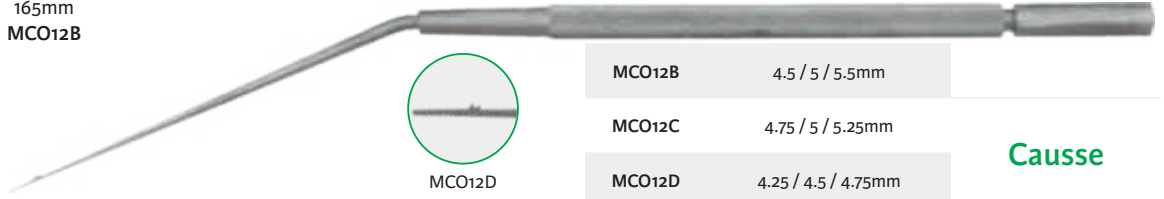

MCO12D

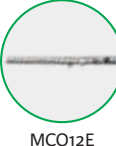

MCO12E

MCO12B	4.5 / 5 / 5.5mm
MCO12C	4.75 / 5 / 5.25mm
MCO12D	4.25 / 4.5 / 4.75mm
MCO12E	5 / 6 / 7 / 8mm
MCO12H	3.5 / 4 / 4.5mm
MCO12J	3.5 / 3.75 / 4mm

Cause

Vincent

Dumon



MCO38 Micro measuring instrument

165mm



MCO12R malleable shaft 3 / 4 / 5mm

Robier

165mm



MCO830 straight shaft 3.5 / 4 / 4.5mm

Charachon

165mm



Micro measuring rod with protection sleeve

malleable

Ossiculoplasty sizer

MCOR45
165mm



MCOR20	MCOR25	MCOR30	MCOR35	MCOR40	MCOR45	MCOR50	MCOR55	MCOR60	MCOR65	MCOR70	MCOR75	MCOR80
2mm	2.5mm	3mm	3.5mm	4mm	4.5mm	5mm	5.5mm	6mm	6.5mm	7mm	7.5mm	8mm

Columella distance measuring rod forceps

Scale 2/3

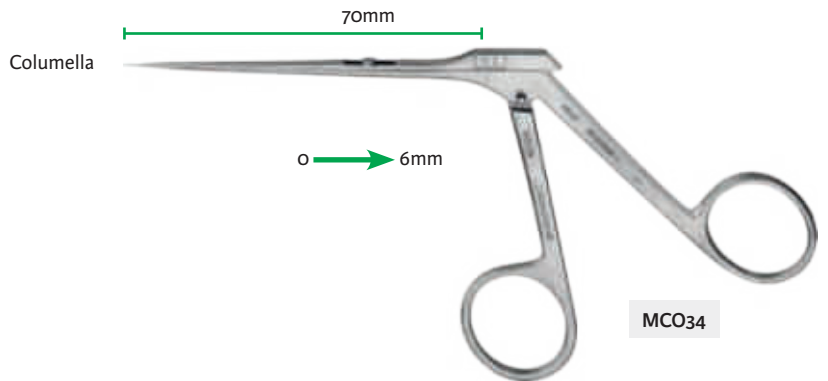

MCO34

Ossiculoplasty sizer



1 → 10mm

MCO844

Sauvage

165mm

Wire guide



MCO997

Legent

165mm

Hubbard Instruments



1352287 Ossicular holding clamp

Micro Punch for silastic



Vincent

MCO571

Ø 2,5 - 0,8mm
for silastic 1128305

Schucknecht device

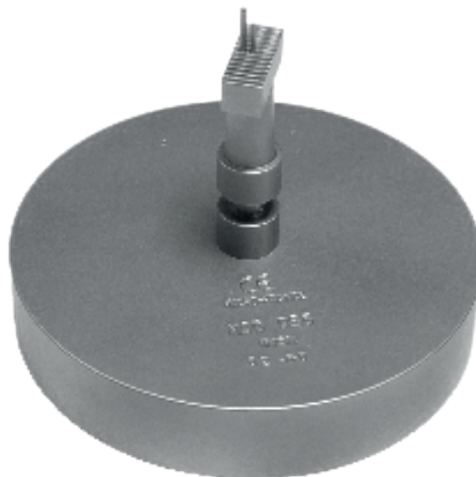

MCO985 Device

Fascia press

Scale 1/3



MCO819



MCO820

Martin

Sheehy

Fascia press

190mm

3724061

23x31mm



Cartilage cutting block

Teixido



MCO255
0.3mm height of cut

Martin

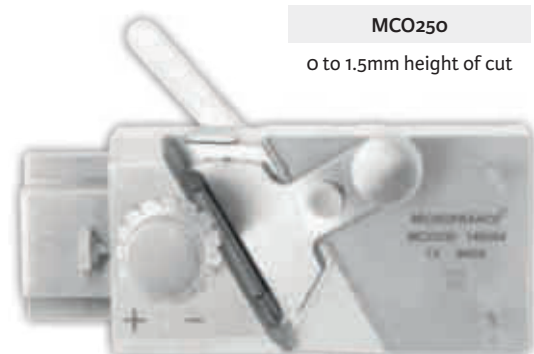

MCO250
0 to 1.5mm height of cut



Replacement blade
MCO251
Pack 10

Hand drill perforator

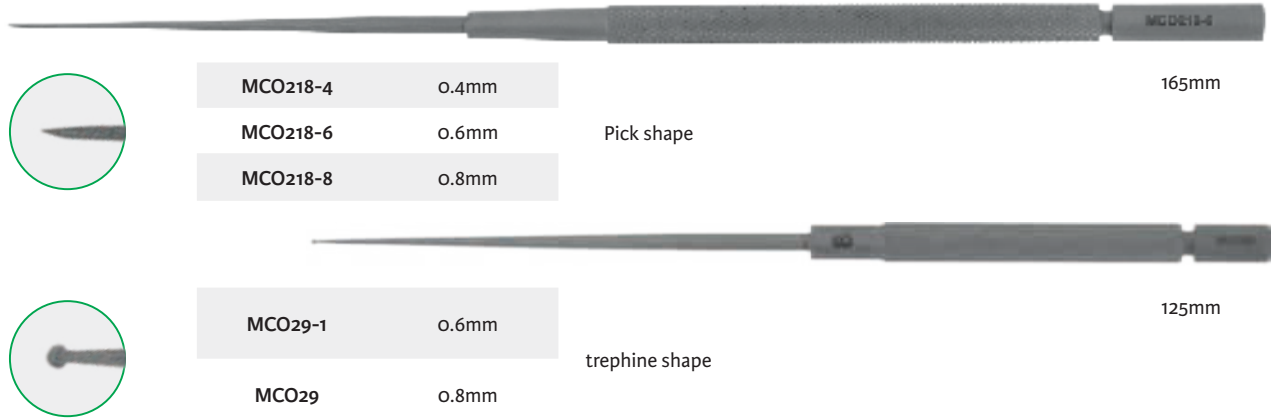

Piston trimming gauge

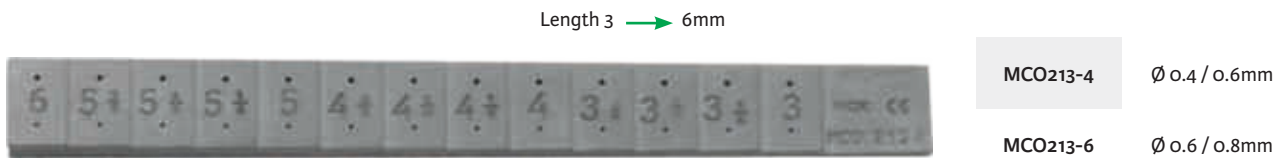

Preparation glass plate - Teflon cutting block

House

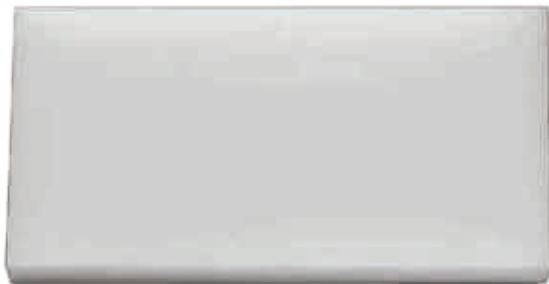

Teflon cutting block

3724064

8x37x78mm

Cause

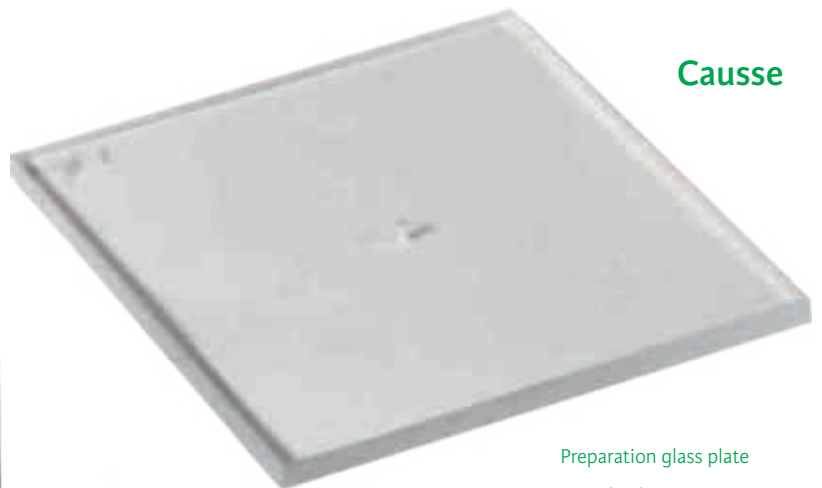

Preparation glass plate

65x65x4mm

with hole

MCO660-10 hole 1.0mm

MCO660-12 hole 1.2mm

MCO660-8 hole 0.8mm

without hole

MCO660-2 65x65x2mm

Otoplasty

Scale 1/1

Stenstrom



Rasp
160mm
2x8mm



CP85R

CP85R

curved right

CP85L

curved left

Stenstrom



Elevators
160mm
2x8mm



CP85AL

CP85AR

curved right

CP85AL

curved left

Suction foot switch

Scale 1/5



Darrouzet

MCO551

Delivered with
Trumpet valve device
and security valve

Accessories for suction foot switch

Scale 1/2

security valve device - Pk 6

trumpet valve device



MCO551B



MCO551A

Temporal bone speciment holder

Scale 1/3































Ø 160mm

MCO823

Composition of Cause set

Reference	Description
7874MF-34	Stainless steel sterilization case 380x205x85mm 340x200x80mm
MCO670-1	Cause sterilization tray metal 335x195mm for container 7874MF-34
MCO12D	Cause measuring rod 4.25/4.5/4.75mm measurements angled shaft 165mm length
MCO12E	Vincent measuring rod 5/6/7/8mm measurements angled shaft 165mm length
MCO12H	Vincent measuring rod 3.5/4/4.5mm measurements angled shaft 165mm length
MCO13C	Hartmann forceps 0.6x3mm serrated jaws WL 65mm
MCO213-4	Piston trimming gauge with 0.4/0.6mm holes from 3 to 6mm 120mm length
MCO27	Dieter malleus nipper forceps 2.3mm jaws WL 65mm
MCO4A	Straight micro scissors blades 3mm tips WL 65mm
MCO571	Vincent punch 2.5x0.8mm diam. for Silastic 1128305
MCO650	Cause knife 90deg 3mm diam. tip bent shaft (A) 165mm length
MCO651	Cause lancet knife 1.5x2mm 45deg bent shaft (B) 165mm length
MCO652	Cause knife 45deg 3mm diam. tip (C) 165mm length
MCO653	Cause lancet knife 1.5x2mm 45deg (D) 165mm length
MCO654-1	Cause tendon hook cutting right 90deg 1.2mm (E1) 165mm length
MCO654-2	Cause tendon hook cutting left 90deg 1.2mm (E2) 165mm length
MCO655	Cause angled curette 2.8mm diam. tip (G) 160mm length
MCO656	Cause incudostapedial joint knife 45deg (H) 165mm length
MCO657	Cause curved pick (I) 160mm length
MCO658	Cause piston crimping forceps WL 65mm
MCO660-10	Cause preparation glass plate 65x65x4mm with hole 1mm diam.
MCO660-12	Cause preparation glass plate 65x65x4mm with hole 1.2mm diam.
MCO660-2	Cause preparation glass plate 65x65x2mm
MCO660-8	Cause preparation glass plate 65x65x4mm with hole 0.8mm diam.
MCO661-10	Cause malleable suction tube with luer-lock connection 1mm diam. WL 90mm
MCO661-7	Cause malleable suction tube with luer-lock connection 0.7mm diam. WL 90mm
MCO662-1	Cause anterior curved hook 0.4mm tip angled shaft (O1) 165mm length
MCO662-2	Cause posterior curved hook 0.4mm tip angled shaft (O2) 165mm length
MCO663-1	Cause anterior curved hook 0.2mm tip angled shaft (P1) 165mm length
MCO663-2	Cause posterior curved hook 0.2mm tip angled shaft (P2) 165mm length
MCO664	Cause anterior hook 90deg 0.4mm tip angled shaft (Q) 165mm length
MCO665	Cause anterior hook 90deg 0.7mm tip angled shaft (R) 165mm length
MCO666	Cause curved pick blunt (S) 165mm length
MCO667	Cause flap elevator 2x3mm 45deg 165mm length
MCO820	Martin fascia press
MCO841	Cause hook 90deg (F) 165mm length

Composition of the complete set on request

		
MCO13C	MCO213-4	MCO27
		
MCO4A	MCO571	MCO820
		
MCO650	MCO651	MCO652
		
MCO653	MCO654-1	MCO654-2
		
MCO655	MCO656	MCO657
		
MCO662-1	MCO663-1	MCO665
		
MCO657	MCO658	MCO841
		
MCO12H	MCO12E	MCO661-10
		
MCO660-12	MCO660-2	
		
MCO670-1	7874MF-34	

Picture for information, without scale

MCO901



Instruments 165 mm angled shaft

Straight pick	Chisel	Anterior hook 90° 0.2mm	Posterior hook 90° 0.2mm	Anterior hook 45° 0.9mm	Raspatory upward	Raspatory backward
MCO901	MCO910M	MCO915	MCO916	MCO920	MCO917	MCO918



Instruments 165 mm straight shaft

Knife 45° 2.8X3.5mm	Blunt hook 90° 0.8mm	Elevator 60° 1.3x2mm	Angled elevator right	Angled elevator left	Ball probe 1mm
MCO932	MCO950	MCO904	MCO905	MCO906	MCO924



Double elevators

	MCO925 180mm 3mm		MCO929 170mm double angled
	MCO926 180mm flat 1.7 / 5mm		MCO951 170mm curved
	MCO928 175mm curved 0.9mm		

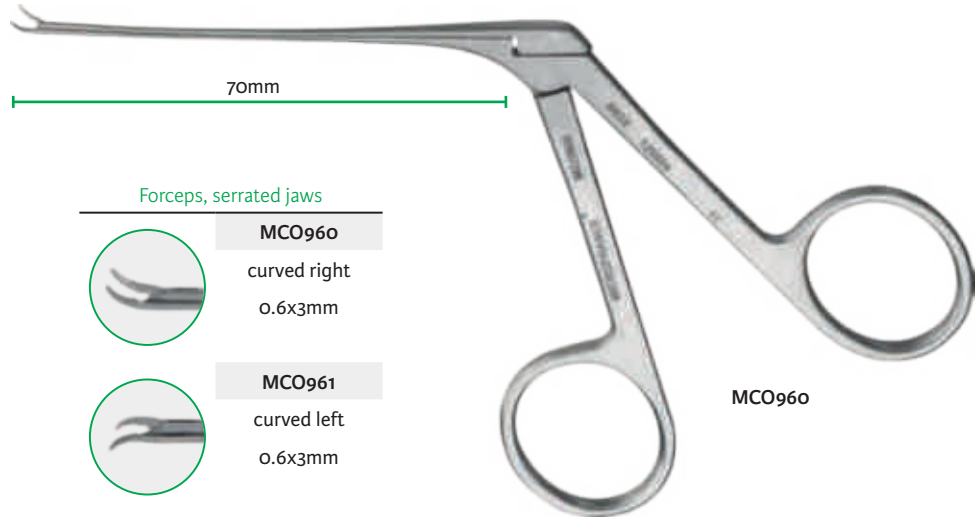

Forceps, serrated jaws

	MCO960 curved right 0.6x3mm
	MCO961 curved left 0.6x3mm

MCO960



Whirlybird elevator, angled, 165mm

- A**  3722001 0,75mm left
- 3722002 0,75mm right

Curved pick 165mm

- B**  3722003 large curvatrue

Sickle knife 160mm

- C**  3722008 3mm

Footplate hook 90° 160mm

- D**  3722011 0,33mm

Guilford-Wright instruments



Micro hook 0,5mm 165mm



3722020 45°

3722021 90°

Shea instrument



Micro hook 90° 165mm



3722142 1mm



Whirlybird knife 155mm

A		3722029	left	0,75x5mm
----------	---	---------	------	----------

Micro knife 165mm

B		3722031	45°	Ø 2mm
----------	--	---------	-----	-------

Hook 90° 165mm

C		3722035	0,6mm	
----------	---	---------	-------	--

Stapedectomy hook 165mm

D		3724287	45°	0,33mm
----------	--	---------	-----	--------

Excavator, angled shaft, 160mm

E		3724291	90°	0,5mm
----------	---	---------	-----	-------

Sickle knife 165mm

A		3722036	7,5mm
----------	---	---------	-------

Knife curette 45° 165mm
Sheehy

B		3722038	Ø 2mm
		3722039	Ø 2,5mm

Tympanoplasty sickle knife 165mm

C		3722040	curved 7mm
----------	--	---------	---------------

Incudostapedial joint knife 155mm

D		3722041	60° 0,75mm
		3722042	20° 0,5x1,5mm

Curved separator, bayonet shaft
165mm

E		3722046	1,5mm
----------	---	---------	-------

Angled curette double ended 175mm

		3722050	Ø 1,1 / 1,3mm
F			light angled
		3722049	Ø 1,1 / 1,3mm
		3722051	Ø 2,2 / 2,5mm



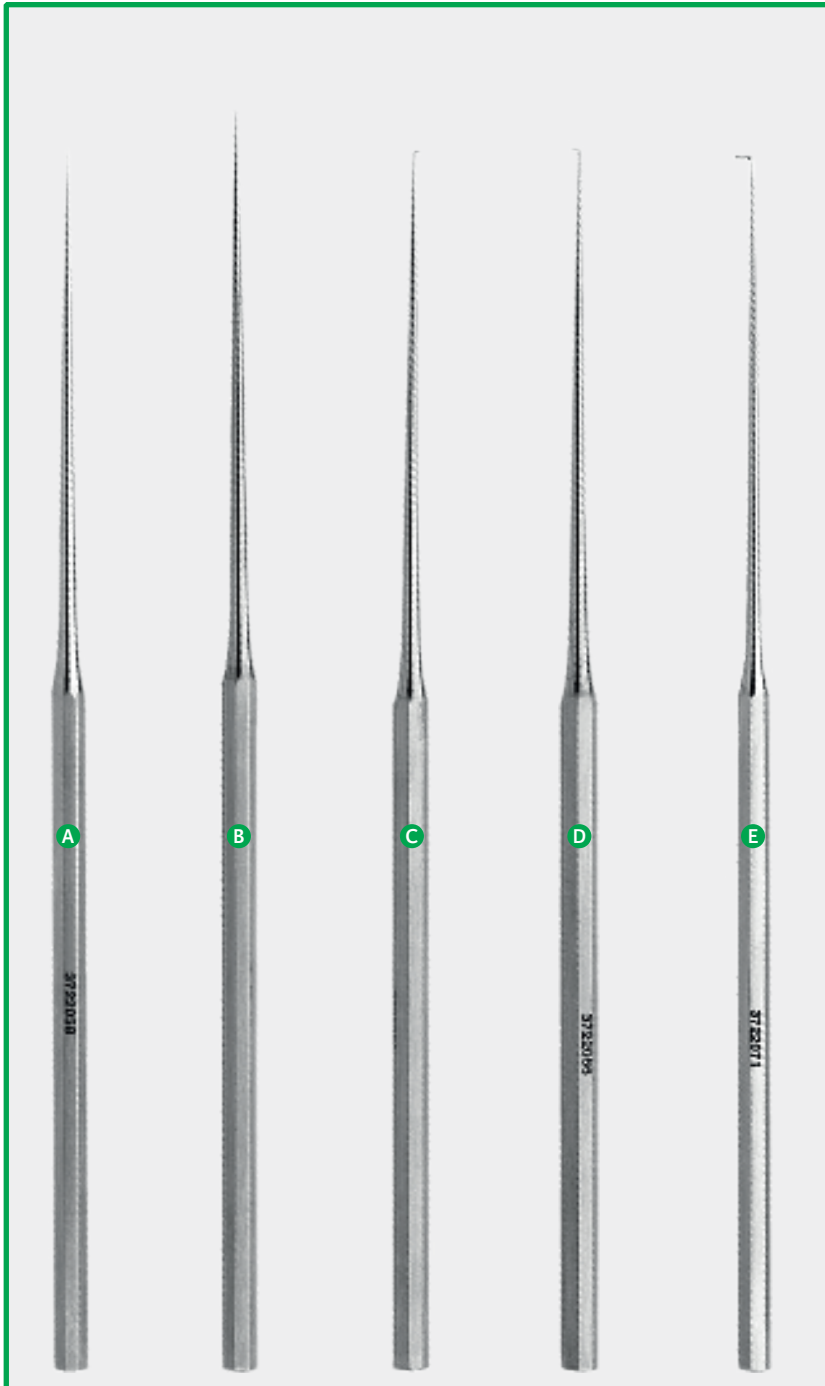

Micro straight pick 160mm
House-Barbara

A		3722058	malleable shaft
----------	--	---------	-----------------

Micro oval window hook 165mm

B		3722060	90°	0,33mm
		3722061	90°	0,66mm

Micro pick 90° 160mm

C		3722062	0,5mm	Strut
----------	--	---------	-------	--------------

Micro hook 90° 160mm

D		3722066	1mm	House
----------	--	---------	-----	--------------

Micro dissector 90° 160mm

E		3722071	0,5 x 2,5mm	Crabtree
----------	--	---------	-------------	-----------------

Micro dissector 220mm

1		3714780	3mm
----------	--	---------	-----

Micro elevator 1,25x2,5mm 165mm

1		3714781	20°	Perkins
----------	--	---------	-----	----------------

1 entire instrument, not shown

Jordan instrument



Stapedectomy lancet knife 165mm



3724293 45° 2x3mm

Rosen instruments



Curved pick, angled from tip, 160mm



3722117 curvature 3mm

3722118 angled 1,5mm

Paparella instrument



Micro curved elevator 160mm



3722115 3,5mm

Duckbill

Canal knife 45° 160mm

A		3722083	Ø 2mm
		3722084	Ø 2,5mm

Facial nerve dissector 140mm

B	3722089	angled smooth jaws	McCabe
		14mm	

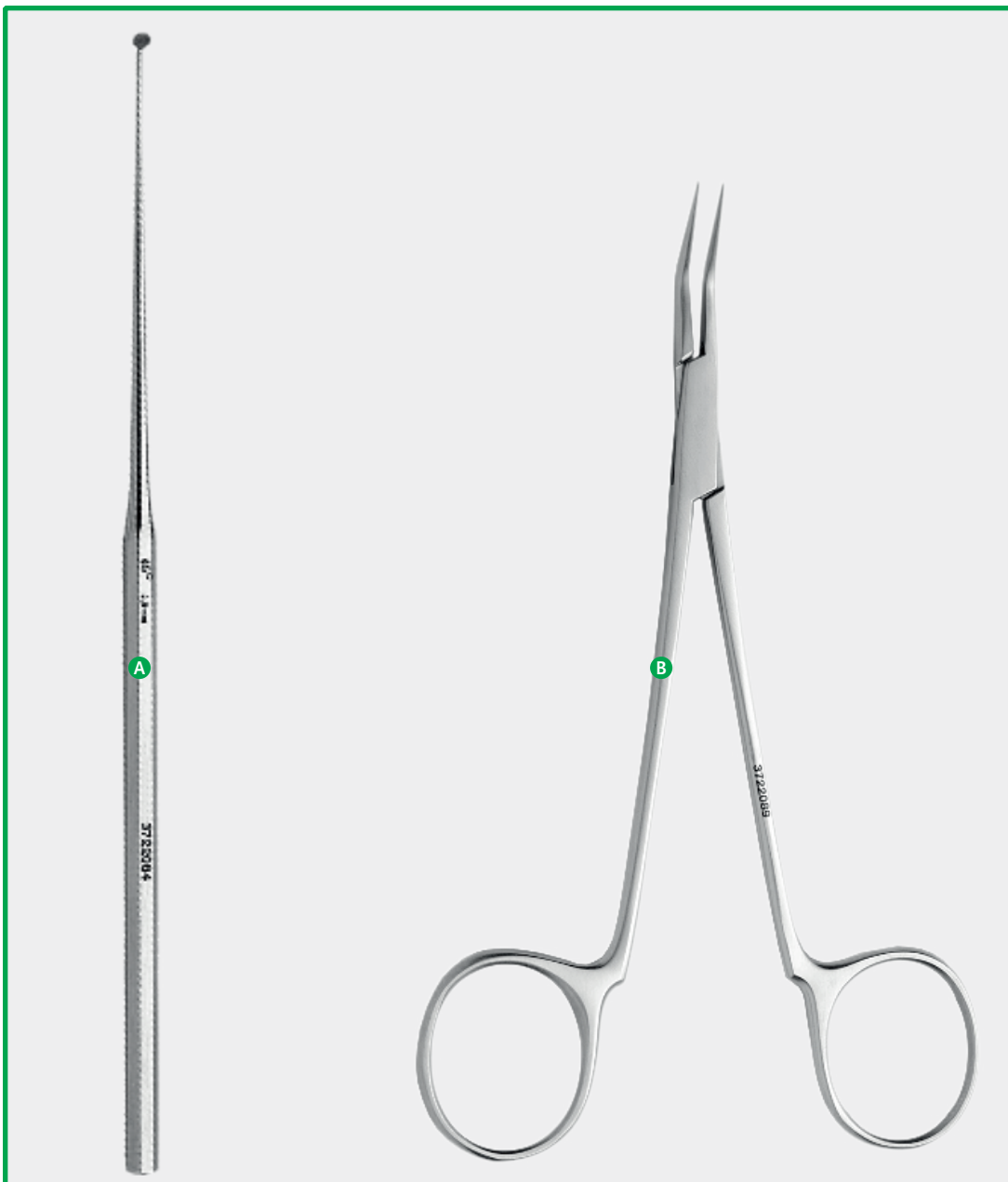

Micro raspatory - Micro hook



MCO9-1

Raspatory 90°



MCO804

Hook 90° 0,7mm

Micro double angled elevator



MCO929

double angled

Marquet



MCO240

double angled

whirlybird

Chobaut



Suction tube adapter - Micro angled suction tube

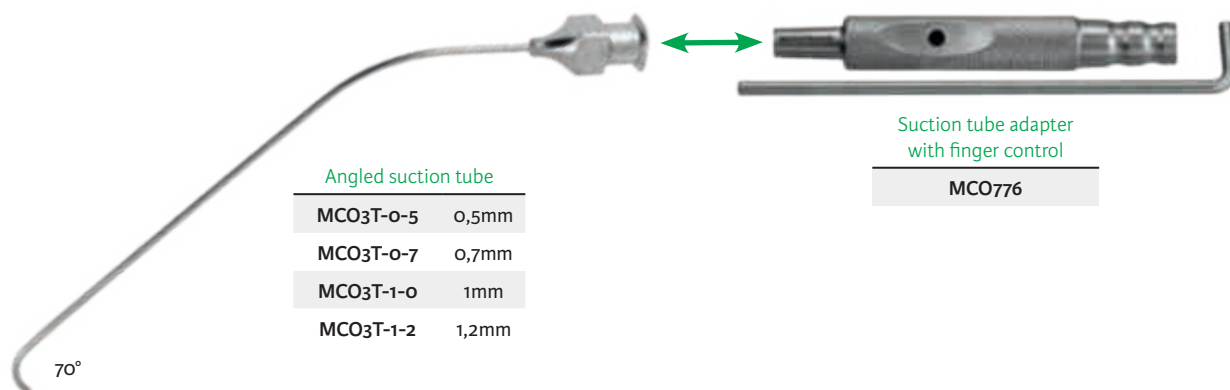

Angled suction tube

MCO ₃ T-o-5	0,5mm
MCO ₃ T-o-7	0,7mm
MCO ₃ T-1-o	1mm
MCO ₃ T-1-2	1,2mm

Suction tube adapter with finger control

MCO776

Micro forceps

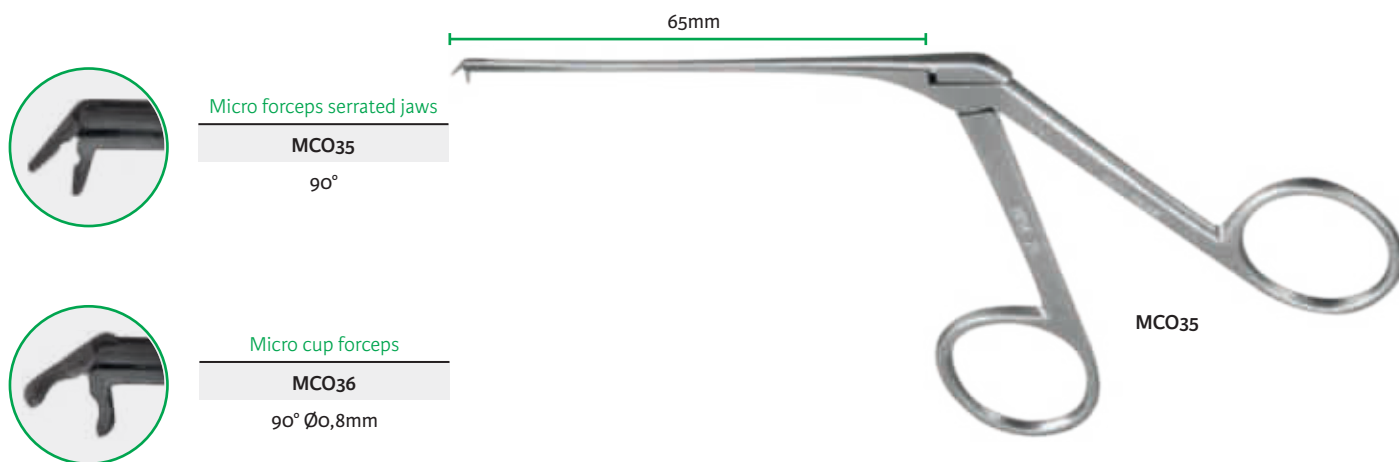

Micro forceps serrated jaws

MCO35
90°

Micro cup forceps

MCO36
90° Ø0,8mm

MCO35

Container - Tray

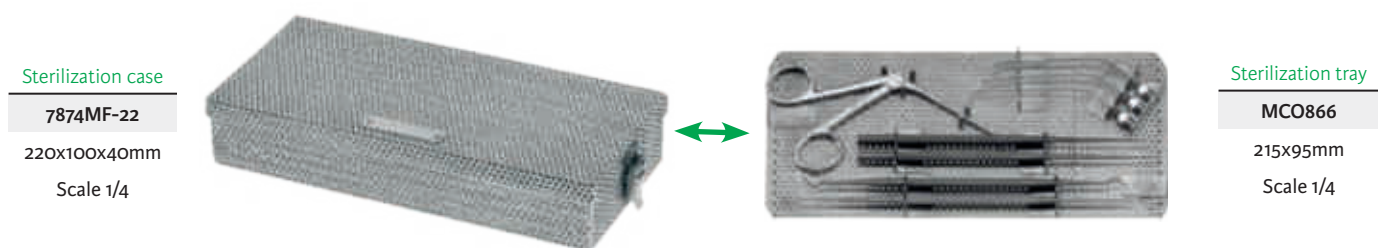

Sterilization case

7874MF-22
220x100x40mm
Scale 1/4

Sterilization tray

MCO866
215x95mm
Scale 1/4

Micro lancet knife

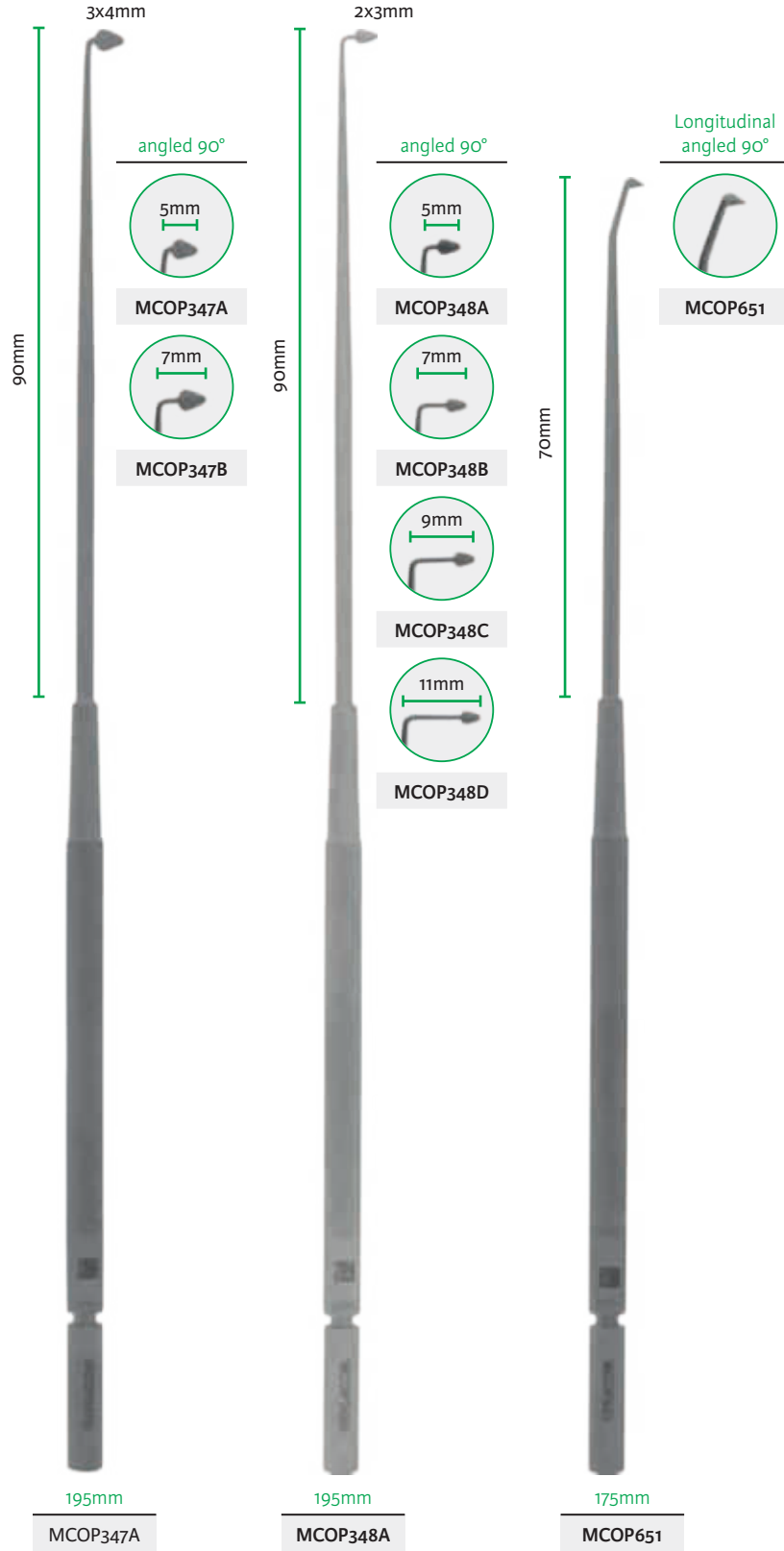

Micro curette



Suction tube elevator



Sterilization tray

MCO821-1

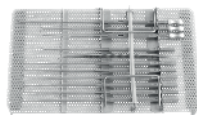

Container
25x15x6cm

7874MF-25

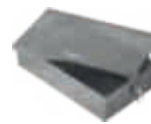

Suction tube with finger control

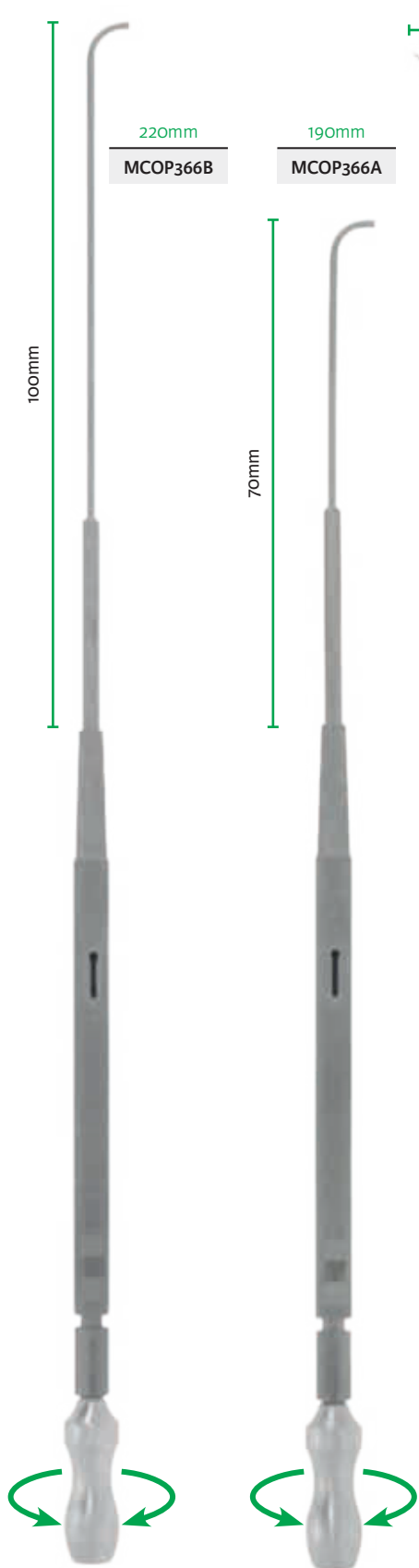

Alligator forceps

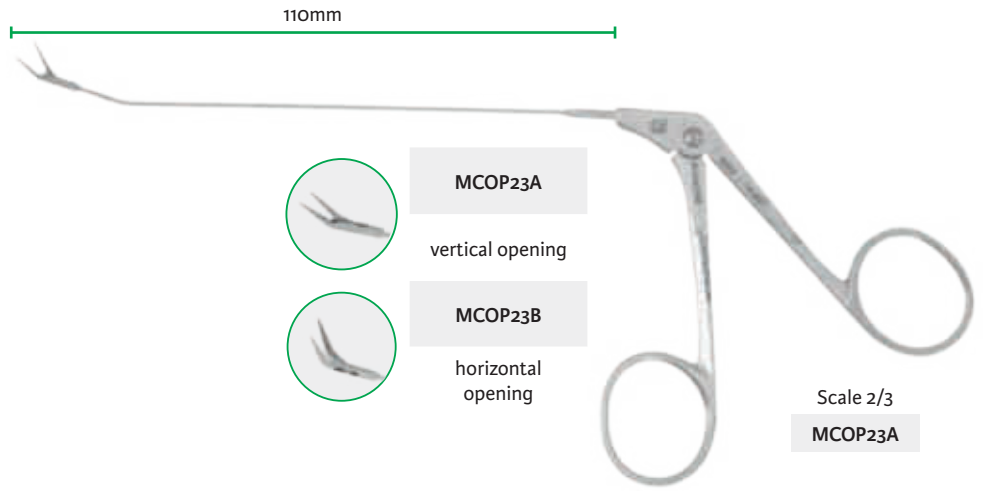

Wire crimper forceps

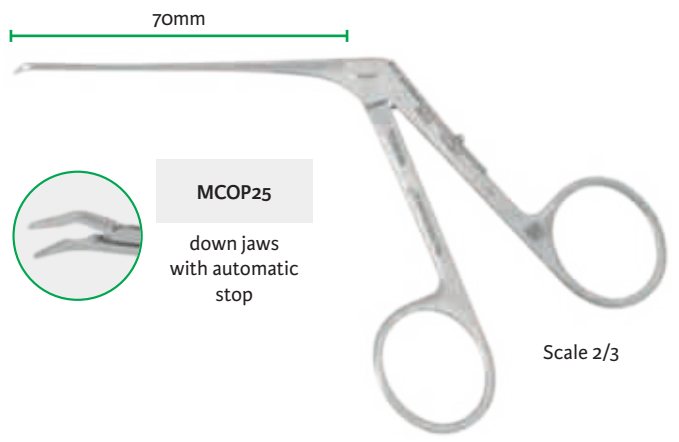

Fascia press

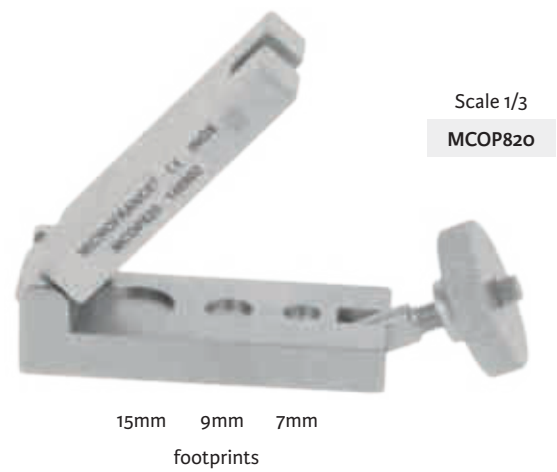

Micro blunt eyes suction tube



Fraysse

L 115mm		L 150mm	
MCO367F10	1mm	MCO368F20	2mm
MCO367F12	1.2mm	MCO368F25	2.5mm
MCO367F15	1.5mm		
MCO367F20	2mm		

115mm

Scale 2/3
«L» Working length

MCO367F10

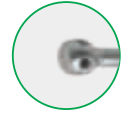

Zimmermann

MCO354	1.2mm
--------	-------

100mm

MCO354

Micro suction tube with finger control



L 110mm		L 140mm	
MCO352E20	2mm	MCO352N20	2mm
MCO352E25	2.5mm	MCO352N25	2.5mm

140mm

blunt eyes suction tube

MCO352N25



MCO770L15	1.5mm	MCO770L30	3mm
MCO770L20	2mm	MCO770L35	3.5mm
MCO770L25	2.5mm	MCO770L40	4mm

120mm

blunt eyes suction tube

MCO770L30

House-Baron

L 100mm	
3724177	1mm

100mm

Micro suction irrigation tube with finger control



Brackman

3724217	0.7 / 0.8mm	3724223	2 / 2.5mm
3724219	0.8 / 1.3mm	3724224	2.3 / 3.3mm
3724221	1.4 / 1.7mm	3724225	2.7 / 4mm
3724222	1.7 / 2.3mm	3724226	4 / 4.7mm

90mm

3724224

90mm

blunt eyes suction tube

MCO352-25

Sterkers

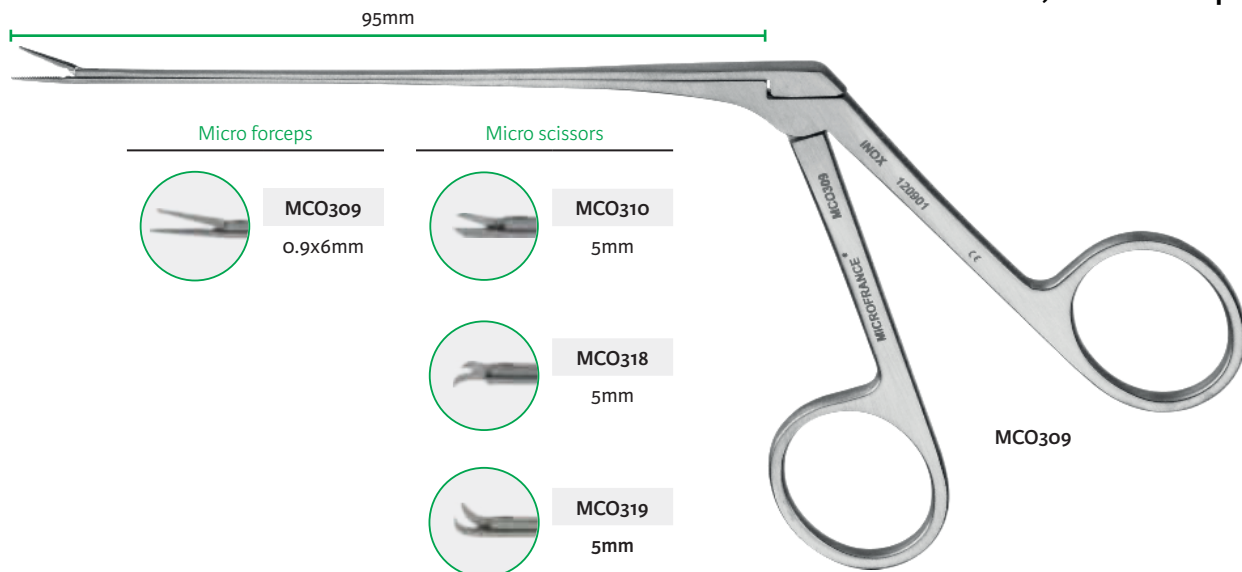

Micro scissors, micro forceps

Self-retaining retractor

Angot-Vaneecloo

Curved self-retaining retractor

MCO351

3x3 prongs
with 3 malleable blades
9x65mm 9x75mm 12x55mm

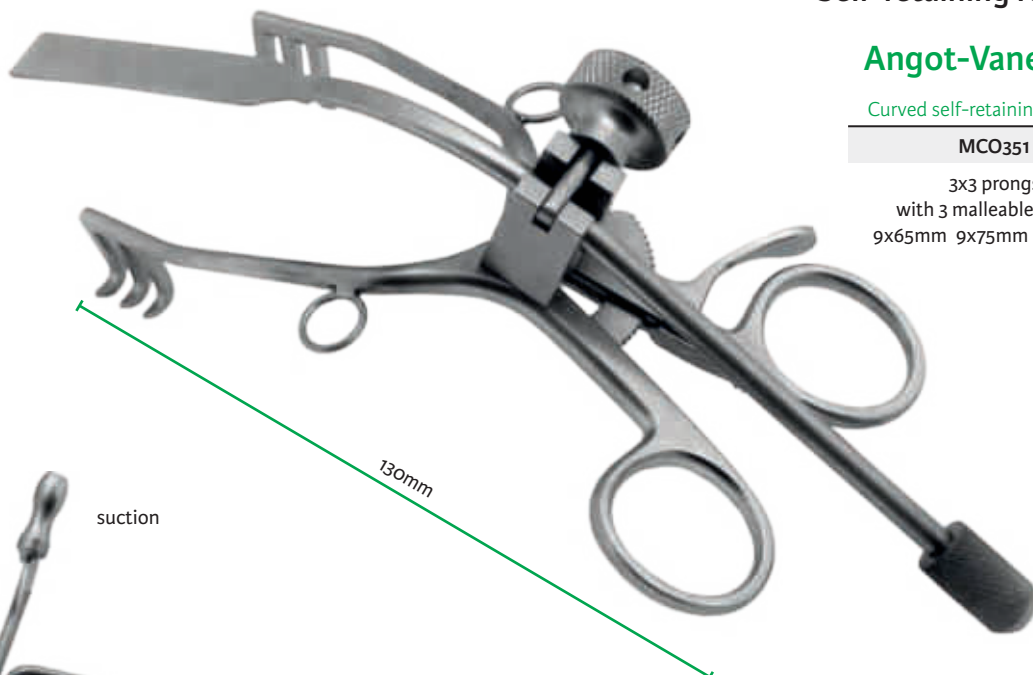

Robier

articulated self-retaining retractor

MCO357A

with suction tube blade

Scale 1/2

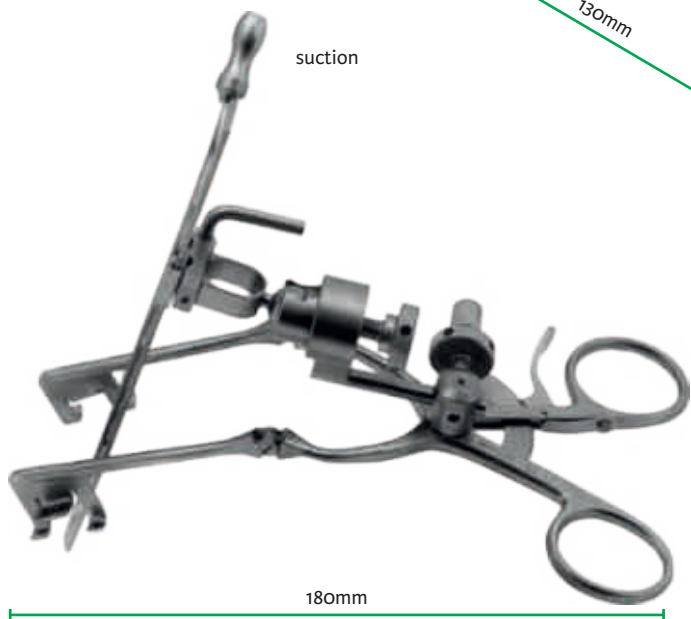

Scale 2/3

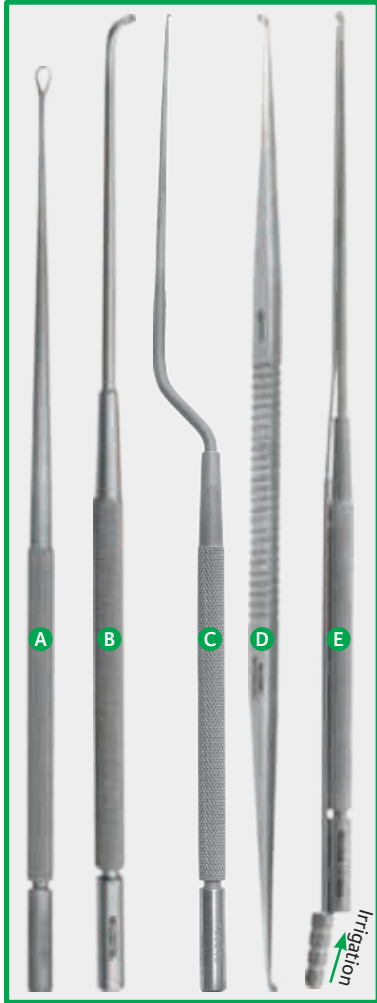

Micro instruments

Sterkers

Sickle knife 180mm		MCO301	7mm
		MCO302	90° 2mm
Hook 180mm		MCO303	90° 1.2mm
		MCO304	90° 0.8mm
Fenestrated curette 180mm		MCO320 MCO321 MCO322	3mm 4mm 6mm

Instruments, tip bayonet shaft

elevator 180mm		MCO16	curved 1.5x7mm
Hook 190mm		MCO341	2mm left
Magnan		MCO340 C	2mm right
Blunt pick 190mm		MCO342	straight
Bruzzo		MCO343	curved

Elevator and raspatory

Whirlybied elevator 180mm		MCO337DL B	left
Dubreuil		MCO337DR	right
Raspatory 175mm		MCO224G	45° 7x4mm
Gentine			
Elevator 195mm		MCO333	curved 1.5x7mm
Klap			

Mom micro instruments

Mom

Angled curette double 190mm		MCO7AMO D	2.2 / 2.5mm n° 1/2
Oval knife 190mm		MCO6M E	2x2.5mm with irrigation
Sickle knife 190mm		MCO10MO	5mm with irrigation
Curved pick 190mm		MCO221MO	with irrigation
Ball seeker 190mm		MCO330MO	2mm 90° with irrigation

Micro cup forceps

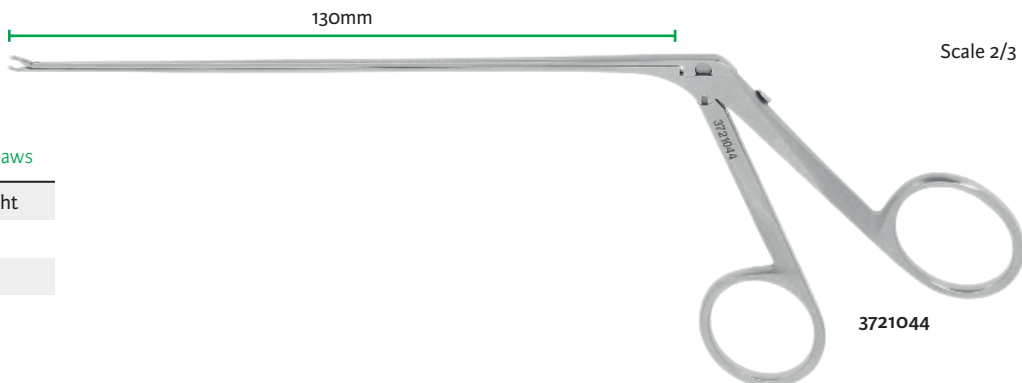

Cup forceps, 1mm jaws

3721042	straight
3721043	left
3721044	right

3721044







Micro instruments



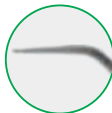

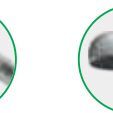

Selesnick

Scale 2/3

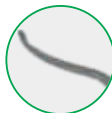

190mm

Hook			Knife 45°			Curette	
							
MCOS14	MCOS15	MCOS16	MCOS17	1mm	MCOS25	MCOS26	
45° 3mm	90° 2mm	90° 2.8mm	MCOS18	2mm	∅ 1mm straight	∅ 1mm angled	
			MCOS19	3mm			

Elevator					Sickle knife	
						
MCOS20	MCOS21	MCOS22	MCOS23	MCOS30	MCOS31	MCOS32
14 x1.5mm	3mm	5x1mm	7x2mm	left	right	5mm

Cup forceps, micro scissors

125mm

Scale 2/3



MCOS27

Cup forceps	
	
MCOS27	MCOS29
1mm	3mm

Micro scissors, blades 7mm			
			
MCOS33	MCOS34	MCOS35	MCOS36
straight	angled up	left curved	right curved

Curved self-retaining retractor

Angot-Vaneecloo

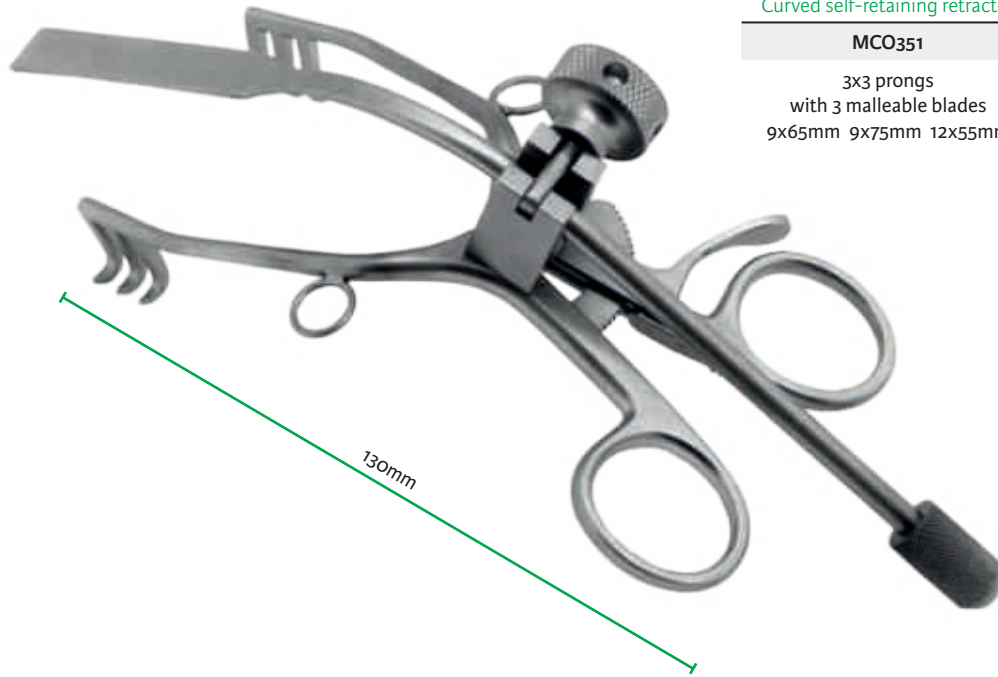

Curved self-retaining retractor

MCO351

3x3 prongs
with 3 malleable blades
9x65mm 9x75mm 12x55mm

Bipolar forceps

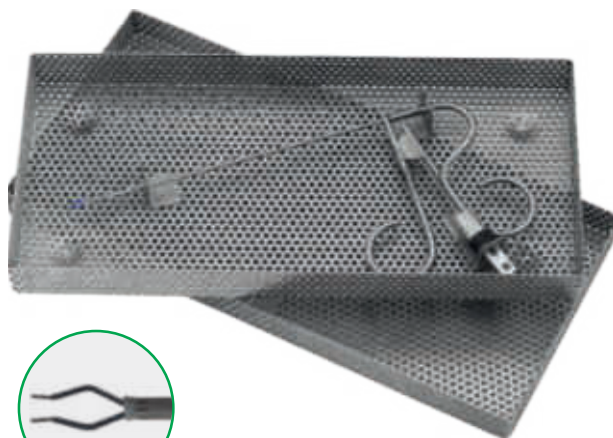

Page 36

Bipolar forceps

MCO291

Working length 120mm
with box and tray
Scale 1/3

Sterilization case

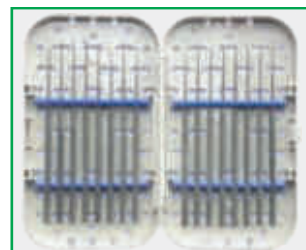
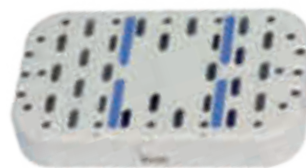

Plastic sterilization case

3717022

210x123x36mm
for 16 instruments
Scale 1/5

Knife		Burr				Drill burr	
Diamond	Tungsten round burr	Diamond	Perforer six sided	Six sided	Drill burr	Lindemann Drill burr	
shaft 44mm	shaft 65mm	shaft 65mm	shaft 65mm	shaft 65mm	shaft 55mm	shaft 33mm	shaft 50mm

MCO702-22^(D)
Pack 1
Ø 22 mm



Ø mm	Pack 1	Pack 1	Pack 6	Pack 1	Pack 4	Pack 1	Pack 1
0.6	236HM-0-6 ^(D)	242-0-6 ^(D)	-	-	-	-	-
0.7	-	242-0-7 ^(D)	-	-	-	-	-
0.8	236HM-0-8 ^(D)	242-0-8 ^(D)	-	-	-	-	-
1.0	236HM-1-0 ^(D)	242-1-0 ^(D)	-	-	-	-	-
1.2	-	-	-	-	2035512C4 ^(D)	-	-
1.4	236HM-1-4 ^(D)	242-1-4 ^(D)	-	-	-	-	-
1.5	-	-	-	-	2035515C4 ^(D)	-	-
1.8	236HM-1-8 ^(D)	242-1-8 ^(D)	-	-	-	164RS-1-8 ^(D)	-
2.3	236HM-2-3 ^(D)	242-2-3 ^(D)	141P23 ^(D)	-	-	-	168RS ^(D)
2.7	236HM-2-7 ^(D)	242-2-7 ^(D)	141P27 ^(D)	-	-	-	-
3.0	236HM30 ^(D)	-	-	-	-	-	-
3.1	-	242-3-1 ^(D)	141P31 ^(D)	141RS-3-1 ^(D)	-	-	-
3.5	236HM-3-5 ^(D)	242-3-5 ^(D)	-	-	-	-	-
4.0	236HM-4-0 ^(D)	242-4-0 ^(D)	-	141RS-4-0 ^(D)	-	-	-
4.5	236HM-4-5 ^(D)	242-4-5 ^(D)	-	-	-	-	-
5.0	236HM-5-0 ^(D)	242-5-0 ^(D)	-	141RS-5-0 ^(D)	-	-	-
6.0	-	242-6-0 ^(D)	-	-	-	-	-
7.0	236HM-7-0 ^(D)	242-7-0 ^(D)	-	-	-	-	-

Sterilization tray



MCO865-1

for 26 burs - Scale 1/5

Sterilization case



7874MF-22

240x105x45mm 220x100x40mm - Scale 1/5

^(D) Distributed by Integra MicroFrance SAS (France) - For corresponding manufacturer part numbers, see table in annex

Stainless steel cup



7876-60^(D)

Cup

7876-60 ^(D)	60mm
7876-80 ^(D)	80mm
7876-100 ^(D)	100mm
7876-120 ^(D)	120mm
7876-160 ^(D)	160mm

Stainless steel sterilization tray



7872-24^(D)
Scale 1/2

Tray

7872-24 ^(D)	240x180mm
------------------------	-----------

Surgical instrument paraffin oil



Paraffin oil

MCO731 ^(D)

^(D) Distributed by Integra MicroFrance SAS (France) - For corresponding manufacturer part numbers, see table in annex

Scale 1/5



7874MF-22

240x105x45mm
220x100x40mm



MCO865-1

for 26 burs

Scale 1/5

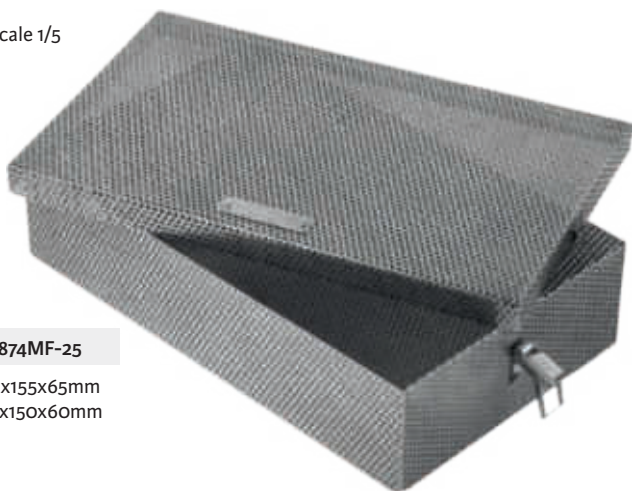

7874MF-25

270x155x65mm
250x150x60mm



MCO821-1

12 micro instruments

Scale 1/5

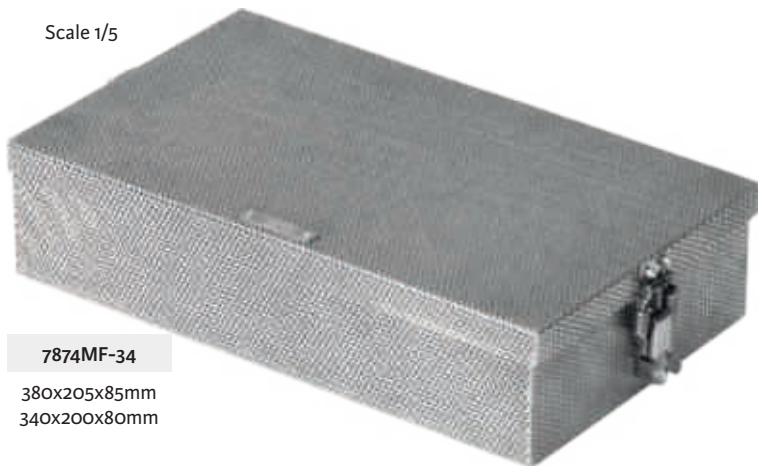

7874MF-34

380x205x85mm
340x200x80mm

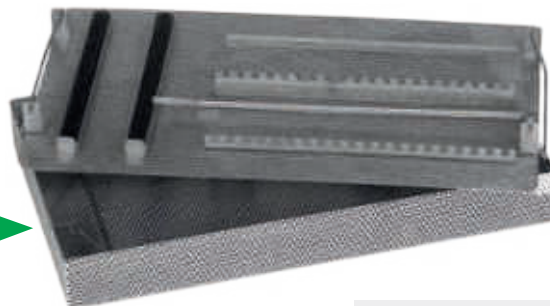

MCO824-1

Set micro instruments

Scale 1/5



7874MF-40

440x205x95mm - 400x200x90mm

Echelle 1/4

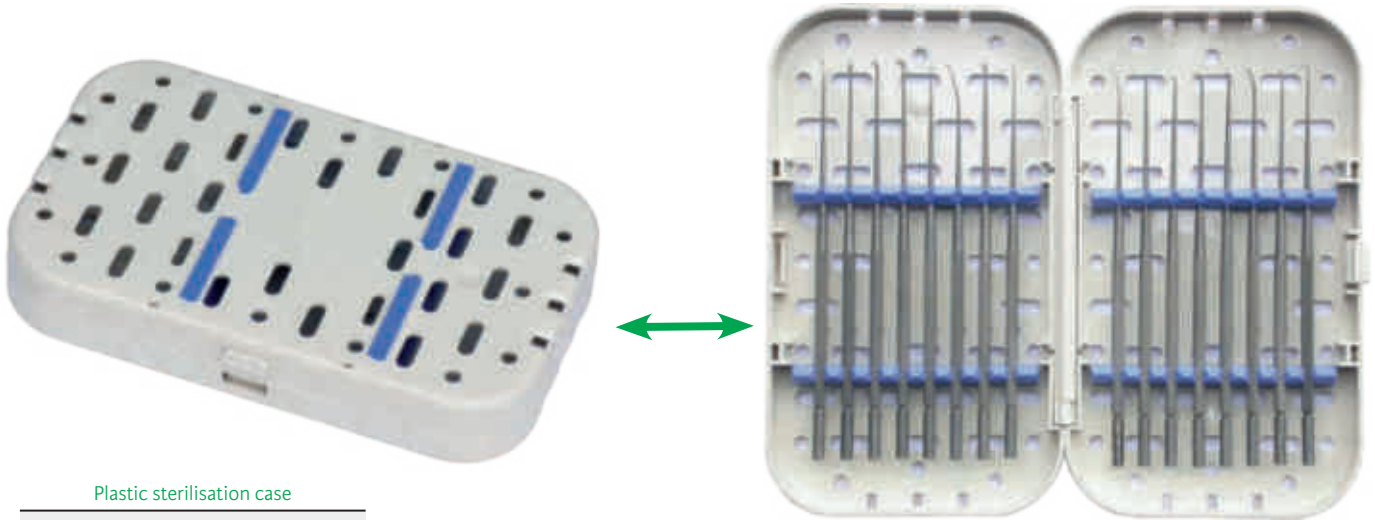

Plastic sterilisation case

3717022

210x123x36mm

for 16 micro instruments



Aluminum sterilization tray

3717025

248x221x45mm

for 32 micro instruments

Numerical index

O

O-28	20
O-28-1	20
O-28-2	20
O-28-3	21
O-28-4	21
O-28-7	22
O-28-8	20

1

141P23 ^(D)	87
141P27 ^(D)	87
141P31 ^(D)	87
141RS-3-1 ^(D)	87
141RS-4-0 ^(D)	87
141RS-5-0 ^(D)	87
164RS-1-8 ^(D)	87
168RS ^(D)	87
1003IG ^(D)	8
1003LI ^(D)	8
1004IG ^(D)	8
1005I ^(D)	8
1352247	23
1352287	64
1352321	7
1358270	48
1359254	48
1359256	48
1359258	48
1359260	48
1359262	48
1359264	48
1362275	13
1411000	7
1411050	7
1458230	7
1458231	7
1458232	7
1458233	7
1458234	7
1458275	7
1458276	7

2

236HM-0-6 ^(D)	87
236HM-0-8 ^(D)	87
236HM-1-0 ^(D)	87
236HM-1-4 ^(D)	87
236HM-1-8 ^(D)	87
236HM-2-3 ^(D)	87
236HM-2-7 ^(D)	87
236HM-3-5 ^(D)	87
236HM-4-0 ^(D)	87
236HM-4-5 ^(D)	87
236HM-5-0 ^(D)	87
236HM-7-0 ^(D)	87
236HM30 ^(D)	87

242-0-6 ^(D)	87
242-0-7 ^(D)	87
242-0-8 ^(D)	87
242-1-0 ^(D)	87
242-1-4 ^(D)	87
242-1-8 ^(D)	87
242-2-3 ^(D)	87
242-2-7 ^(D)	87
242-3-1 ^(D)	87
242-3-5 ^(D)	87
242-4-0 ^(D)	87
242-4-5 ^(D)	87
242-5-0 ^(D)	87
242-6-0 ^(D)	87
242-7-0 ^(D)	87
2035512C4 ^(D)	87
2035515C4 ^(D)	87

3

3712015	27
3712016	27
3712017	27
3712021	27
3714001	44
3714002	44
3714003	44
3714004	44
3714006	44
3714027	19
3714028	19
3714250	44
3714780	75
3714781	75
3717022	86, 90
3717025	90
3721000	5
3721001	5
3721002	50
3721004	50
3721005	5
3721006	52
3721007	52
3721008	55
3721009	55
3721012	55
3721013	55
3721014	50
3721015	55
3721016	55
3721018	50
3721020	50
3721021	52
3721022	52
3721023	50
3721024	50
3721025	50
3721026	50
3721027	50
3721028	50
3721029	50

3721030	50
3721032	52
3721036	50
3721037	52
3721038	52
3721039	52
3721040	52
3721041	52
3721042	84
3721043	84
3721044	84
3721045	53
3721046	53
3722001	71
3722002	71
3722003	71
3722008	71
3722011	71
3722020	72
3722021	72
3722029	73
3722031	73
3722035	73
3722036	74
3722038	74
3722039	74
3722040	74
3722041	74
3722042	74
3722046	74
3722049	74
3722050	74
3722051	74
3722058	75
3722060	75
3722061	75
3722062	75
3722066	75
3722071	75
3722083	77
3722084	77
3722089	77
3722115	76
3722117	76
3722118	76
3722142	72
3722149	6
3722150	6
3722151	6
3723001	52
3723005	52
3723006	52
3723008	52
3724013	4
3724024	4
3724059	17
3724060	17
3724061	65
3724064	66
3724066	21
3724067	21

3724068	21
3724069	21
3724074	27
3724083	52
3724084	52
3724085	52
3724102	9
3724103	9
3724104	9
3724108	10
3724109	10
3724110	10
3724111	10
3724112	10
3724113	10
3724114	10
3724122	10
3724125	10
3724126	10
3724127	10
3724128	10
3724142	10
3724143	10
3724144	10
3724161	10
3724172	47
3724173	47
3724175	47
3724177	82
3724196	46
3724210	47
3724211	47
3724214	48
3724217	82
3724218	47
3724219	82
3724220	47
3724221	82
3724222	82
3724223	82
3724224	82
3724225	82
3724226	82
3724244	22
3724247	22
3724265	5
3724266	52
3724269	55
3724287	73
3724291	73
3724293	76
3724309	52
3724310	52
3724311	52
3724312	52
3724316	13
3724370	55
3724401	10
3724402	10
3724403	10
3724404	10

^(D) Distributed by Integra MicroFrance SAS (France) - For corresponding manufacturer part numbers, see table in annex

3724405.....	10
3724406.....	10
3724407.....	10
3724408.....	10
3724409.....	10
3724410.....	10
3724411.....	10
3724420.....	46
3724421.....	46
3724422.....	46
3740012.....	33
3740028.....	34
3740038.....	34
3744027.....	38
3755000.....	42
3755001.....	42
3755010.....	41
3755101.....	39
3755102.....	39
3755106.....	39
3755107.....	39
3755110.....	39
3755111.....	39
3755114.....	40
3755116.....	40
3755117.....	40
3755136.....	40
3755160.....	42
3755161.....	42

7

702T.....	38
703T.....	38
704T.....	38
714T.....	38
7718.....	3
7719-2.....	2
7721-1.....	6
7725.....	6
7725P1.....	6
7725P2.....	6
7725P3.....	6
7726MF.....	14
7727.....	14
7728.....	14
7731.....	2
7732-1.....	14
7733.....	14
7734.....	14
7764.....	27
7766.....	24
7768.....	18
7768-1.....	18
7779MF-1.....	15
7779MF-2.....	15
7779MF-3.....	15
7779MF-5CC.....	15
7781.....	23
7782-1-2.....	19
7783-12.....	15

7787-10.....	17
7831A-12.....	33
7831A-15.....	35
7833A-12.....	33
7833A-15.....	35
7866-13.....	42
7867-1.....	39
7867-2.....	39
7867-3.....	39
7867-4.....	39
7872-24 ^(D)	88
7874MF-22.....	79, 87, 89
7874MF-25.....	80, 89
7874MF-34.....	68, 69, 89
7874MF-40.....	89
7875 ^(D)	4
7876-60 ^(D)	88
7876-80 ^(D)	88
7876-100 ^(D)	88
7876-120 ^(D)	88
7876-160 ^(D)	88
7885.....	3
7885A.....	3
7886.....	3
7888.....	3
7897.....	11
7898.....	11
7899.....	11
7903-50-5 ^(D)	15

8

8812-1.....	9
8812-2.....	9
8812-3.....	9
8812-4.....	9
8812-5.....	9
8814T1.....	9
8814T2.....	9
8814T3.....	9
8814T4.....	9
8814T5.....	9

9

9912-7 ^(D)	9
9912-8 ^(D)	9
9912-9 ^(D)	9
9913-1 ^(D)	9
9913-2 ^(D)	9
9913-3 ^(D)	9
9913-4 ^(D)	9
9913-5 ^(D)	9
9913-6 ^(D)	9
9511007.....	14

CEV

CEV984.....	12
CEV985.....	12

CP

CP16.....	29
CP16-1.....	29
CP17.....	18
CP17-1.....	18
CP17-2.....	18
CP17-3.....	18
CP21-3.....	19
CP21A-3.....	19
CP37.....	33
CP85AL.....	67
CP85AR.....	67
CP85L.....	67
CP85R.....	67
CP300.....	25
CP302-2.....	58
CP302-3.....	58
CP302-4.....	58
CP302-5.....	58
CP302-6.....	58
CP302-8.....	58
CP330-3-0.....	43
CP330-4-0.....	43
CP332.....	33
CP335.....	19
CP351-2.....	31
CP351-3.....	31
CP351-6.....	31
CP351-7.....	31
CP352.....	32
CP352-1.....	32
CP352-2.....	32
CP352-3.....	32
CP353.....	29
CP354.....	29
CP354A.....	29
CP356.....	29
CP358.....	29
CP358A.....	29
CP363.....	30
CP380.....	28
CP380-1.....	28
CP380-2.....	28
CP380-3.....	28
CP380-5.....	28
CP390-1.....	37
CP390-2.....	37
CP390-8.....	37
CP391E.....	37, 62
CP391M.....	37, 62
CP391V.....	37, 62
CP392-1R.....	36
CP392-2R.....	36
CP392-8R.....	36
CP392BI.....	36
CP392BS.....	36
CP393-2.....	36, 62
CP393-3.....	36, 62
CP393-4.....	36, 62
CP400.....	35

CP400-1.....	33
CP406.....	33
CP407.....	35
CP414.....	33
CP415.....	35
CP604.....	34
CP604-15.....	34
CP604BR.....	36
CP604M.....	37
CP605.....	34
CP605-15.....	34
CP605BR.....	36
CP605M.....	37
CP606.....	34
CP606-15.....	34
CP606A.....	34
CP609.....	19
CP611.....	16
CP625.....	16
CP626.....	16
CP627.....	16
CP628.....	18
CP637.....	30
CP801-7.....	26
CP801-10.....	26
CP821.....	8
CP821B.....	7
CP821C.....	7
CP821D.....	7
CP821E.....	7
CP822-10.....	18
CP822-12.....	18
CP822-14.....	18
CP823-5.....	26
CP824-5.....	26
CP825.....	17
CP907.....	25
CP919.....	29
CP919A.....	29
CP922.....	30
CP922A.....	30
CP922B.....	30
CP931.....	31
CP931-1.....	31
CP933-14.....	35
CP934.....	35
CP934-1.....	35
CP938-1.....	33
CP941.....	18
CP985.....	16
CP988-15.....	35
CP1107.....	38

M

M832.....	34
M833.....	34

^(D) Distributed by Integra MicroFrance SAS (France) - For corresponding manufacturer part numbers, see table in annex

MCEN

MCEN23-2-5.....45
MCEN23-3-0.....45
MCEN770J30.....43
MCEN770J40.....43

MCL

MCL359.....23

MCO

MCO1B.....45
MCO2.....56
MCO3Po5.....48
MCO3Po7.....48
MCO3P10.....48
MCO3P12.....48
MCO3P15.....48
MCO3P18.....48
MCO3P20.....48
MCO3P24.....48
MCO3T-0-5.....79
MCO3T-0-7.....79
MCO3T-1-0.....79
MCO3T-1-2.....79
MCO4.....51
MCO4A.....51, 68, 69
MCO4B.....51
MCO4C.....51
MCO4D.....51
MCO4E.....51
MCO4F.....51
MCO5.....56
MCO5A-1-0.....56
MCO5A-1-5.....56
MCO5A-2-0.....56
MCO5A-2-5.....56
MCO5B.....56
MCO5C.....56
MCO5D.....56
MCO5E.....56
MCO6.....56
MCO6A.....60
MCO6B.....60
MCO6C.....56
MCO6M.....84
MCO7-1.....58
MCO7-3.....58
MCO7A-1.....58
MCO7A-3.....58
MCO7A-5.....58
MCO7A6.....58
MCO7AMO.....84
MCO8.....57
MCO8B.....57
MCO8BM.....62
MCO9.....61
MCO9-1.....61, 78

MCO10.....56
MCO10B.....56
MCO10M.....56
MCO10MO.....84
MCO12B.....63
MCO12C.....63
MCO12D.....63, 68
MCO12E.....63, 68, 69
MCO12H.....63, 68, 69
MCO12J.....63
MCO12R.....63
MCO13A.....49
MCO13B.....49
MCO13C.....49, 68, 69
MCO13D.....49
MCO13E.....49
MCO14A.....57
MCO16.....84
MCO17.....49
MCO21.....51
MCO21A.....51
MCO21B.....51
MCO21C.....51
MCO21D.....51
MCO21G.....51
MCO21H.....51
MCO21I.....51
MCO22.....49
MCO23.....49
MCO23A.....49
MCO23B.....49
MCO24.....49
MCO25.....54
MCO25H.....54
MCO26.....54
MCO27.....53, 68, 69
MCO29.....66
MCO29-1.....66
MCO31.....59
MCO32.....59
MCO34.....63
MCO35.....79
MCO36.....79
MCO37.....57
MCO37-1.....57
MCO37D.....57
MCO37G.....57
MCO38.....63
MCO201-2-5.....43
MCO201-3-0.....43
MCO204B.....56
MCO204C.....56
MCO205.....60
MCO205A.....60
MCO205B.....60
MCO205C.....60
MCO205D.....60
MCO207-1-5.....58
MCO207-2-0.....58
MCO209.....61

MCO210.....57
MCO213-4.....66, 68, 69
MCO213-6.....66
MCO214-13-10.....26
MCO214-13-20.....26
MCO214-13-40.....26
MCO214-13-60.....26
MCO214-13-80.....26
MCO215.....56
MCO216-3-5.....57
MCO218-4.....66
MCO218-6.....66
MCO218-8.....66
MCO219C.....49
MCO221.....59
MCO221A.....59
MCO221MO.....84
MCO222.....53
MCO224-2-0.....57
MCO224A-2-0.....57
MCO224G.....84
MCO226.....60
MCO226A.....60
MCO226B.....60
MCO226C.....60
MCO233.....11
MCO237.....11
MCO240.....57, 78
MCO250.....65
MCO251.....65
MCO255.....65
MCO270.....53
MCO271.....53
MCO272.....53
MCO290.....62
MCO291.....62, 86
MCO301.....84
MCO302.....84
MCO303.....84
MCO304.....84
MCO305.....16
MCO309.....83
MCO310.....83
MCO311-1-0.....45
MCO311-1-2.....45
MCO311-1-5.....45
MCO311-1-8.....45
MCO311-2-0.....45
MCO311-2-5.....45
MCO311-3-0.....45
MCO311-3-5.....45
MCO311-4-0.....45
MCO312.....56
MCO313.....56
MCO317.....56
MCO318.....83
MCO319.....83
MCO320.....84
MCO321.....84
MCO322.....84

MCO330MO.....84
MCO333.....84
MCO337DL.....84
MCO337DR.....84
MCO340.....84
MCO341.....84
MCO342.....84
MCO343.....84
MCO351.....83, 86
MCO352-20.....82
MCO352-25.....82
MCO352-30.....82
MCO352E20.....82
MCO352E25.....82
MCO352N20.....82
MCO352N25.....82
MCO354.....82
MCO357A.....83
MCO366F10.....48
MCO366F12.....48
MCO366F15.....48
MCO366F20.....48
MCO367F10.....82
MCO367F12.....82
MCO367F15.....82
MCO367F20.....82
MCO368F20.....82
MCO368F25.....82
MCO551.....67
MCO551A.....67
MCO551B.....67
MCO571.....64, 68, 69
MCO650.....56, 68, 69
MCO651.....56, 68, 69
MCO651F.....56
MCO652.....56, 68, 69
MCO653.....56, 68, 69
MCO654-1.....60, 68, 69
MCO654-2.....60, 68, 69
MCO655.....58, 68, 69
MCO656.....61, 68, 69
MCO657.....59, 68, 69
MCO658.....54, 68, 69
MCO660-2.....66, 68, 69
MCO660-8.....66, 68
MCO660-10.....66, 68
MCO660-12.....66, 68, 69
MCO661-7.....48, 68
MCO661-10.....48, 68, 69
MCO662-1.....60, 68, 69
MCO662-2.....60, 68
MCO663-1.....60, 68, 69
MCO663-2.....60, 68
MCO664.....60, 68
MCO665.....60, 68, 69
MCO666.....59, 68
MCO667.....57, 68
MCO670-1.....68, 69
MCO702-22^(D).....87
MCO731^(D).....88

^(D) Distributed by Integra MicroFrance SAS (France) - For corresponding manufacturer part numbers, see table in annex

MCO770-1-5	43	MCO890-1-12	46
MCO770-2-0	43	MCO890-1-15	46
MCO770-2-5	43	MCO890-1-20	46
MCO770-3-0	43	MCO901	59, 70
MCO770-3-5	43	MCO904	70
MCO770-4-0	43	MCO905	57, 70
MCO770L15	82	MCO906	57, 70
MCO770L20	82	MCO910M	70
MCO770L25	82	MCO915	60, 70
MCO770L30	82	MCO916	60, 70
MCO770L35	82	MCO917	70
MCO770L40	82	MCO918	70
MCO771-2-5	43	MCO920	60, 70
MCO771-3-0	43	MCO924	70
MCO771-4-0	43	MCO925	70
MCO772	45	MCO926	70
MCO773	46	MCO928	70
MCO774-0-4	46	MCO929	57, 70, 78
MCO774-0-5	46	MCO932	70
MCO774-0-6	46	MCO950	2, 60, 70
MCO774D8	46	MCO951	57, 70
MCO775-1	45	MCO960	49, 70
MCO776	45, 79	MCO961	49, 70
MCO781	6	MCO970	61
MCO782L	54	MCO971T	61
MCO782R	54	MCO972	61
MCO800	59	MCO973T	61
MCO801	59	MCO974	61
MCO802	59	MCO978	12
MCO803	16	MCO978S	12
MCO804	61, 78	MCO979	17
MCO805	2	MCO980	12
MCO805A	2	MCO981	12
MCO806	60	MCO981D	12
MCO806A	60	MCO982	12
MCO806B	60	MCO983	12
MCO807	2, 60	MCO983-4	12
MCO813	59	MCO985	64
MCO817	57	MCO988	17
MCO818	58	MCO989	62
MCO819	65	MCO995	24
MCO820	65, 68, 69	MCO997	64
MCO821-1	80, 89		
MCO823	67		
MCO824-1	89		
MCO830	63		
MCO832A	60		
MCO832B	60		
MCO832C	60		
MCO832D	60		
MCO833C	60		
MCO833D	60		
MCO841	60, 68, 69		
MCO844	64		
MCO865-1	87, 89		
MCO866	79		
MCO890	46		
MCO890-1-04	46		
MCO890-1-08	46		
MCO890-1-10	46		

MCOR

MCOR20	63
MCOR25	63
MCOR30	63
MCOR35	63
MCOR40	63
MCOR45	63
MCOR50	63
MCOR55	63
MCOR60	63
MCOR65	63
MCOR70	63
MCOR75	63
MCOR80	63
MCOS	
MCOS14	85
MCOS15	85
MCOS16	85
MCOS17	85
MCOS18	85
MCOS19	85
MCOS20	85
MCOS21	85
MCOS22	85
MCOS23	85
MCOS25	85
MCOS26	85
MCOS27	85
MCOS29	85
MCOS30	85
MCOS31	85
MCOS32	85
MCOS33	85
MCOS34	85
MCOS35	85
MCOS36	85

S

SM63 ^(D)	7
SM64 ^(D)	7
SM65 ^(D)	7

N

N480G	51
-------	----

P

P761-7	39
P761-8	39
P762-2	40
P762-4	40
P763	41
P764-1	40
P764-3	40
P764-5	40
P764-7	40
P764-11	40
P765-14	41
P765-16	41
P769	41

MCOP

MCOP7A3	80
MCOP23A	81
MCOP23B	81
MCOP25	81
MCOP337A	80
MCOP347A	80
MCOP347B	80
MCOP348A	80
MCOP348B	80
MCOP348C	80
MCOP348D	80
MCOP366A	81
MCOP366B	81
MCOP651	80
MCOP820	81

^(D) Distributed by Integra MicroFrance SAS (France) - For corresponding manufacturer part numbers, see table in annex



**Table for corresponding
manufacturer part numbers
For information purposes only**

Integra MicroFrance® product reference	Corresponding manufacturer part number	Integra MicroFrance® product reference	Corresponding manufacturer part number
1003IG	M3IG	7876-100	310
1003LI	M3LI	7876-120	312
1004IG	M4IG	7876-160	316
1005I	M5I	7876-60	306
141P23	41R3F1C923	7876-80	308
141P27	41R3F1C927	7903-50-5	13.202
141P31	41R3F1C931	9912-7	6617-7
141RS-3-1	39141RF106031	9912-8	6617-8
141RS-4-0	39141RF106040	9912-9	6617-9
141RS-5-0	39141RF106050	9913-1	6611
164RS-1-8	39164RF104018	9913-2	6612
168RS	39168RF105023	9913-3	6613
2035512C4	41L3A16120	9913-4	6614
2035515C4	41L3A16150	9913-5	6615
236HM-0-6	2900236106006	9913-6	6616
236HM-0-8	2900236106008	MCO702-22	580911D104220
236HM-1-0	2900236106010	MCO731	430490
236HM-1-4	2900236106014	SM63	SM63
236HM-1-8	2900236106018	SM64	SM64
236HM-2-3	2900236106023	SM65	SM65
236HM-2-7	2900236106027		
236HM30	2900236106030		
236HM-3-5	2900236106035		
236HM-4-0	2900236106040		
236HM-4-5	2900236106045		
236HM-5-0	2900236106050		
236HM-7-0	2900236106070		
242-0-6	59LH242106006		
242-0-7	59LH242106007		
242-0-8	59LH242106008		
242-1-0	59LH242106010		
242-1-4	59LH242106014		
242-1-8	59LH242106018		
242-2-3	59LH242106023		
242-2-7	59LH242106027		
242-3-1	59LH242106031		
242-3-5	59LH242106035		
242-4-0	59LH242106040		
242-4-5	5900242106045		
242-5-0	59LH242106050		
242-6-0	59LH242106060		
242-7-0	5900242106070		
7872-24	1224		
7875	1724		

Global alphabetical index

A

Adapter	45
Adson	34, 36, 37
Adson-Brown	34
Adson-Tubiana	34
Aesculap	36, 37, 62
Allis	42
Angot-Vaneecloo	83, 86
Austin	71

B

Backauss	42
Ball probe	59
Ball seeker	84
Baron	47
Barraya	35
Becker	38
Beckman	11
Bellucci	46, 50, 52
Bellucci-Wullstein	21
Benezeth	45
Beyer	28
Billeau	3
Bipolar	
Bipolar cable	36, 62
Bipolar forceps	36
Bizeau	23
Blade	
Knife blade lancet tip	7
Knife blade pointed sharp tip	7
Knife blade round tip	7
Malleable blade	12
Micro Otologic blade	7
Myringotomy blade	7
Myringotomy knife spear blade	7
Replacement blade	65
Bordure	62
Bowa	36, 37, 62
Brackman	82
Bregeat	30
Bruzzo	84
Buck	4
Burr	87

C

Cable	36, 37, 62
Cartilage cutting block	65
Castroviejo	33
Causse	48, 54, 57, 58, 59, 60, 61, 63, 66, 68, 69
Chaput	42
Charachon	46, 59, 60, 63, 82
Chisel	26
Chobaut	57, 78
Chouard	15
Chuck	7
Citelli	27
Corgill-Hartmann	5
Cottle	16
Cotton carrier	2
Crabtree	75
Crile	40
Crile-Wood	38
Cup	88
Curette	
Angled curette	58
Curette	58
Curved curette	80
Fenestrated curette	58
Knife curette	74
Straight curette	58

D

Darrouzet	12, 67
Debakey	35
Desmarres	18
Devèze	12
Device	64
Dieter	53, 68, 69
Dieter-Charachon	53
Dissector	
Dissector	75
Facial nerve dissector	77
Spatula dissector	85
Dubreuil	84
Duckbill	50, 76
Dumon	63

E

Elevator	
Angled elevator	57
Curved elevator	57
Elevator	16, 57, 70
Flap elevator	57
Micro suction tube elevator with finger control	80
Monopolar elevator	62
Whirlybird elevator	57
Erbe	36, 37, 62
Excavator	73

F

Farabeuf	17, 18
Farrior	9, 10
Fascia press	65
Fenestrometer	63
Ferguson-Frazier	44
Fisch	52
Fleury	16, 17, 26
Flexible tension arm	12, 13
Forceps	
Alligator forceps	49
Angled forceps serrated jaws	5
Bipolar forceps	36
Crimper forceps	55
Crocodile forceps	49
Crura nipper forceps	55
Cup forceps	5
Dissecting forceps	14
Dissecting forceps serrated jaws	14
Forceps serrated jaws	49
Forceps smooth jaws	50
Forceps with teeth	42
Haemostatic forceps	39, 40, 41
Malleus crimper forceps	55
Malleus nipper forceps	53
Metallic crimper forceps	54
Microcut forceps	53
Monopolar forceps	37
Piston crimper forceps	54, 68, 69
Piston crimping forceps	54
Punch rongeur forceps	27
Spoon jaws forceps	14
Wire crimper forceps	54
Fox	29

Frayse	48, 54, 56, 82
Frazier	44
Freer	16

G

Garabédian	7, 57
Gentine	84
Gillies	18
Gimmick	57
Gouge	26
Greven	50
Gruber	10
Guilford-Wright	48, 72

H

Halsey	38
Halsted	39
Halsted-Mosquito	39
Hand drill perforator	66
Handle	6, 7
Hartman-Herzfeld	52
Hartmann	5, 10, 11, 49, 68, 69
Hartmann-Mosquito	39
Hook	
Foot plate hook	71
Hook	18
Stapedectomy hook	73
Hough	55, 73
House	23, 47, 50, 52, 66, 75, 82
House-Barbara	75
House-Baron	82
House-Bellucci	52
House-Dieters	53
House-Strut	50
House-Wullstein	52
Howarth	16
Hubbard	64
Humby	18
Huttenbrink	54

I

Incudostapedial joint knife	61, 68, 69
Insertor	6

J

Jankowski	43
Joint knife	61
Joseph	29
Josephson	56
Jost	26, 56
Juers	55

K

Kelly	40
Kerrison	27
Kerrison-Costen	27
Kidney bowl	4
Klap	84
Knapp	19
Knife	
Diamond knife	87
Knife	56
Knife curette	74
Lancet knife	56
Myringoplasty double knife	6
Sickle knife	56
Kocher	40
Kos	55
Kraus	53

L

Lancet	
Myringotomy lancet	6
Stapedectomy lancet knife	76
Le Mée	9
Legent	2, 9, 12, 60, 62, 64
Lempert	17, 43
Leriche	39
Lindemann	87
Lombard	24
Loop	3
Lucae	14

M

Magnan	36, 84
Mallet	24
Marquet	2, 49, 57, 59, 60, 70, 78
Martel	41
Martin	49, 56, 65, 68, 69
Maspetiol	46
Mayo	32

Mayo-Hegar	38
McCabe	77
McGee	46, 54, 55
McIndoe	35
McKenty	16
Measuring rod	63
Metzenbaum	31
Mirror	56
Mom	84
Monopolar	
Monopolar - Curved monopolar pick	62
Monopolar - Monopolar cable	37, 62
Monopolar - Monopolar elevator	62
Monopolar - Monopolar forceps	37
Morgon	56
Mosquito	39
Myringoplasty	6
Myringotomy	
Lancet handle	6
Myringotomy blade	7
Myringotomy knife spear blade	7
Myringotomy lancet	6

N

Needle-holder	38
Noyes	50

O

Offret	29
Operating room table clamp	12
Ossicular holding clamp	64
Ossiculoplasty sizer	63
Otoabrader rasp	67

P

Panther	50, 52
Paparella-Weitlaner	21
Péan	41
Perkins	21, 75
Pick	
Curved monopolar pick	62
Curved monopolar pick	62
Curved pick	59
Pick	75
Straight pick	59
Plester	17, 21, 56

Politzer	6, 14
Poncet	60
Portmann	61
Preparation glass plate	66, 68
Punch	
<i>Punch</i>	64, 68, 69
<i>Punch rongeur forceps</i>	27
Pushing syringe	15
R	
Raspatory	16
Retractor	
<i>Articulated self-retaining retractor</i>	23
<i>Blunt retractor</i>	18
<i>Double retractor</i>	18
<i>Self-retaining retractor</i>	20
<i>Sharp retractor</i>	19
<i>Sharp retractor, articulated</i>	18
<i>Vascular strip retractor</i>	23
Robier	63, 83
Rochester-Péan	40
Romanet	58
Rongeur	27, 28
Rosen	48, 56, 57
Ryder	38
S	
Saint-Paul	3
Sauvage	64
Schuknecht	20, 47, 55, 64
Scissors	
<i>Angled micro scissors</i>	51
<i>Curved scissors beveled blades</i>	32
<i>Curved scissors blunt tip</i>	30
<i>Curved scissors pointed blades</i>	29
<i>Curved up micro scissors</i>	51
<i>Left curved micro scissors</i>	51
<i>Right curved micro scissors</i>	51
<i>Straight micro scissors</i>	51
Sébileau	16, 17
Selesnick	85
Senn-Miller	19
Separator	74
Shea	13, 30
Sheehy	65, 74
Snellen	3
Speculum	

<i>Diagnostic speculum</i>	9
<i>Self-retaining speculum</i>	11
<i>Speculum</i>	10
<i>Speculum left hand</i>	11
Sprague	4
Sterilization case	68, 69, 89
Stapedectomy	73, 76
Stenstrom	67
Sterilization tray	68, 69, 86, 89, 90
Sterkers	59, 83, 84
Stevens	30
Streiff	29
Struempel	5
Strut	75
Stylet probe caustic holder	2
Suction foot switch	67
Suction irrigation tube	
<i>Blunt eyes suction irrigation tube with finger control</i>	82
<i>Suction irrigation tube with finger control</i>	43
Suction tube	
<i>Angled suction tube</i>	45
<i>Blunt eyes suction tube</i>	48
<i>Blunt eyes suction tube with finger control</i>	82
<i>Curved suction tube</i>	45
<i>Luer-lock US adapter</i>	45
<i>Malleable suction tube</i>	48
<i>Micro suction tube elevator with finger control</i>	80
<i>Suction tube</i>	46
<i>Suction tube adapter with finger control</i>	45
<i>Suction tube finger cutoff graduated</i>	44
<i>Suction tube with finger control</i>	43
Sulcus	57
Surgical instrument paraffin oil	88
Syringe	
<i>Replacement tube for syringe</i>	15
<i>Straight injection needle</i>	15
<i>Syringe</i>	15
<i>Washer</i>	15

T	
Teflon cutting block	66
Teixido	65
Temporal bone specimen holder	67
Tenotome	59
Terrier	41
Thomassin	61, 78, 79
Tieck-Halle	11
Tobey	5
Towel clamp	41
Trautmann	3

U	
Universal tray	88

V	
Vienna	11
Vincent	63, 64, 68, 69
Volkman	19, 58

W	
Weitlaner	20, 22
Weitlaner-Beckmann	23
Weitlaner-Wullstein	20
Wertheimer	43
Wiet	51, 63
Wire guide	64

Z	
Zimmermann	82
Zini	57

Alphabetical index
Search by name

A

Adson	Bipolar forceps	36
Adson-Brown	Dissecting forceps	34
Adson	Dissecting forceps	34
	Dissecting forceps serrated jaws	34
	Monopolar forceps	37
Adson-Tubiana	Dissecting forceps	34
	Dissecting forceps serrated jaws	34
Aesculap	Bipolar cable	36, 62
	Monopolar cable	37, 62
Allis	Forceps with teeth	42
Angot-Vaneecloo	Self-retaining retractor	83, 86
Austin	Foot plate hook	71

B

Backauss	Towel clamp	42
Baron	Suction tube with finger control	47
Barraya	Dissecting forceps	35
Becker	Needle-holder diamond jaws	38
Beckman	Speculum left hand	11
Bellucci	Forceps serrated jaws	50
	Left curved micro scissors	52
	Right curved micro scissors	52
	Straight micro scissors	52
	Suction tube with finger control	46
Bellucci-Wullstein	Self-retaining retractor	21
Benezeth	Suction tube adapter with finger control	45
Beyer	Double-action rongeur	28
Billeau	Oval loop	3
Bizeau	Articulated self-retaining retractor	23
Bordure	Monopolar elevator	62
Bowa	Bipolar cable	36, 62
	Monopolar cable	37, 62
Brackman	Blunt eyes suction irrigation tube with finger control	82
Bregeat	Curved scissors blunt tip	30
Bruzzo	Curved pick	84
	Straight pick	84
Buck	Loop	4

C

Castroviejo	Dissecting forceps	33
Causse	Angled curette	58, 68, 69
	Curved pick	59, 68, 69
	Flap elevator	57, 68
	Hook	60, 68, 69
	Incudostapedial joint knife	61, 68, 69
	Knife	56, 68, 69
	Lancet knife	56, 68, 69
	Malleable suction tube	48, 68, 69
	Measuring rod	63, 68
	Piston crimper forceps	54, 68, 69
	Preparation glass plate	66, 68, 69
	Sterilization tray metal	68, 69
Chaput	Forceps with teeth	42
Charachon	Hook	60
	Measuring rod	63
	Straight pick	59
	Suction tube	46
	Suction tube with finger control	46, 82
Chobaut	Whirlybird elevator	57, 78
Chouard	Pushing syringe	15
Chuck	Scalpel handle	7
Citelli	Punch rongeur forceps	27
Corgill-Hartmann	Angled forceps serrated jaws	5
Cottle	Elevator	16
Crabtree	Dissector	75
Crile	Haemostatic forceps	40
Crile-Wood	Needle-holder tungsten jaws	38

D

Darrouzet	Flexible tension arm	12
	Security valve device	67
	Self-retaining speculum for arm	12
	Suction foot switch	67
	Trumpet valve device	67
Debakey	Dissecting forceps serrated jaws	35
Desmarres	Blunt retractor	18
Devèze	Self-retaining speculum for arm	12
Dieter-Charachon	Malleus nipper forceps	53
Dieter	Malleus nipper forceps	53, 68, 69
Dubreuil	Whirlybird elevator	84
Duckbill	Elevator	76
	Forceps serrated jaws	50
Dumon	Measuring rod	63

E

Erbe	Bipolar cable	36, 62
	Monopolar cable	37, 62

F

Farabeuf	Double retractor	18
	Raspatory	17
Farrior	Speculum	9, 10
Ferguson-Frazier	Suction tube with finger control	44
Fisch	Curved up micro scissors	52
Fleury	Elevator	16
	Gouge	26
	Raspatory	17
Fox	Curved scissors pointed blades	29
Fraysse	Blunt eyes suction tube	48, 82
	Forceps serrated jaws	54
	Lancet knife	56
Frazier	Suction tube finger cutoff graduated	44
Freer	Elevator	16

G

Garabédian	Scalpel handle	7
	Whirlybird elevator	57
Gentine	Raspatory	84
Gillies	Hook	18
Gimmick	Flap elevator	57
Greven	Forceps serrated jaws	50
Gruber	Speculum	10
Guilford-Wright	Angled suction tube	48
	Hook	72

H

Halsey	Needle-holder tungsten jaws	38
Halsted	Haemostatic forceps	39
Halsted-Mosquito	Haemostatic forceps	39
Hartman-Herzfeld	Cup forceps	52
Hartmann	Angled forceps serrated jaws	5
	Forceps serrated jaws	49, 68, 69
	Speculum	10, 11
Hartmann-Mosquito	Haemostatic forceps	39
Hough	Crura nipper forceps	55
	Excavator	73
	Knife	73
	Stapedectomy hook	73

House

Cup forceps	52
Forceps serrated jaws	50
Hook	75
Suction irrigation tube with finger control	47, 82
Teflon cutting block	66
Vascular strip retractor	23

House-Barbara

Straight pick	75
---------------	----

House-Baron

Suction tube with finger control	82
----------------------------------	----

House-Bellucci

Angled micro scissors	52
Left curved micro scissors	52
Right curved micro scissors	52
Straight micro scissors	52

House-Dieters

Malleus nipper forceps	53
------------------------	----

House-Strut

Forceps smooth jaws	50
---------------------	----

House-Wullstein

Cup forceps	52
-------------	----

Howarth

Elevator	16
----------	----

Hubbard

Ossicular holding clamp	64
-------------------------	----

Humby

Sharp retractor, articulated	18
------------------------------	----

Huttenbrink

Metallic crimper forceps	54
--------------------------	----

J

Jankowski	Suction tube with finger control	43
Joseph	Curved scissors pointed blades	29
Josephson	Knife	56
Jost	Chisel	26
	Knife	56
Juers	Crimper forceps	55

K

Kelly	Haemostatic forceps	40
Kerrison-Costen	Punch rongeur forceps	27
Kerrison	Punch rongeur forceps	27
Klap	Curved elevator	84
Knapp	Blunt retractor	19
	Sharp retractor	19
Kocher	Haemostatic forceps	40
Kos	Crimper forceps	55
Kraus	Microcut forceps	53

L

Le Mée	Speculum	9
Legent	Articulated kneecap for arm	12
	Curved monopolar pick	62
	Diagnostic speculum	9
	Ear quick-lock speculum for arm	12
	Flexible tension arm	12
	Hook	2, 60
	Malleable blade	12
	Nasal speculum holder for arm	12
	Wire guide	64
Lempert	Raspatory	17
	Suction tube with finger control	43
Leriche	Haemostatic forceps	39
Lindemann	Drill burr	87
Lombard	Mallet	24
Lucae	Dissecting forceps	14
	Dissecting forceps serrated jaws	14
	Spoon jaws forceps	14

M

Magnan	Bipolar forceps	36
	Hook	84
Marquet	Ball probe	70
	Chisel	70
	Elevator	57, 70, 78
	Forceps serrated jaws	49, 70
	Hook	2, 60, 70
	Knife	70
	Raspatory	70
	Straight pick	59, 70
Martel	Haemostatic forceps	41
Martin	Alligator forceps	49
	Cartilage cutting block	65
	Fascia press	65, 68, 69
	Mirror	56
Maspetiol	Suction tube	46
	Suction tube with finger control	46
Mayo	Curved scissors beveled blades	32
Mayo-Hegar	Needle-holder tungsten jaws	38
McCabe	Facial nerve dissector	77
McGee	Curved suction tube	46
	Malleus crimper forceps	55
	Wire crimper forceps	54
McIndoe	Dissecting forceps	35
	Dissecting forceps serrated jaws	35
McKenty	Raspatory	16
Metzenbaum	Curved scissors blunt tip	31

Mom	Angled curette	84
	Ball seeker	84
	Curved pick	84
	Knife	84
	Sickle knife	84
Morgon	Sickle knife	56
Mosquito	Haemostatic forceps	39

N

Noyes	Forceps serrated jaws	50
--------------	-----------------------	----

O

Offret	Curved scissors pointed blades	29
---------------	--------------------------------	----

P

Panther	Alligator forceps	50
	Straight micro scissors	52
Paparella-Weitlaner	Self-retaining retractor	21
Péan	Haemostatic forceps	41
Perkins	Elevator	75
	Self-retaining retractor	21
Plester	Knife	56
	Raspatory	17
	Self-retaining retractor	21
Politzer	Dissecting forceps	14
	Dissecting forceps serrated jaws	14
	Lancet handle	6
	Myringotomy lancet	6
	Spoon jaws forceps	14
Poncet	Hook	60
Portmann	Hook	61
	Straight pick	61

R

Robier	Articulated self-retaining retractor	83
	Measuring rod	63
Rochester-Péan	Haemostatic forceps	40
Romanet	Angled curette	58
Rosen	Angled suction tube	48
	Curved elevator	57
	Knife	56
	Sickle knife	56
Ryder	Needle-holder tungsten jaws	38

S

Saint-Paul	Oval loop	3
Sauvage	Ossiculoplasty sizer	64
Schuknecht	Device	64
	Self-retaining retractor	20
	Suction tube with finger control	47
	Wire crimper forceps	55
Sébileau	Elevator	16
	Raspatory	17
Selesnick	Angled curette	85
	Angled elevator	85
	Angled micro scissors	85
	Cup forceps	85
	Curved elevator	85
	Hook	85
	Knife	85
	Left curved micro scissors	85
	Right curved micro scissors	85
	Sickle knife	85
	Spatula dissector	85
	Straight curette	85
	Straight micro scissors	85
	Whirlybird elevator	85
Senn-Miller	Double retractor	19
Shea	Curved scissors blunt tip	30
	Ear speculum holder	13
Sheehy	Fascia press	65
	Knife curette	74
Snellen	Oval loop	3
Sprague	Loop	4
Stenstrom	Elevator	67
	Otoabrader rasp	67
Sterkers	Ball probe	59
	Fenestrated curette	84
	Forceps serrated jaws	83
	Hook	84
	Left curved micro scissors	83
	Right curved micro scissors	83
	Sickle knife	84
	Straight micro scissors	83
Stevens	Curved scissors blunt tip	30
Streiff	Curved scissors pointed blades	29
Struempel	Cup forceps	5
Strut	Pick	75
Sulcus	Curved elevator	57

T

Teixido	Cartilage cutting block	65
Terrier	Haemostatic forceps	41
Thomassin	Angled suction tube	79
	Cup forceps	79
	Forceps serrated jaws	79
	Hook	61, 78
	Raspatory	61, 78
	Sterilization tray metal	79
Tieck-Halle	Speculum	11
Tobey	Angled forceps serrated jaws	5
Trautmann	Loop	3

V

Vienna	Speculum	11
Vincent	Measuring rod	63, 68, 69
	Punch	64, 68, 69
Volkman	Curette	58
	Sharp retractor	19

W

Weitlaner-Beckmann	Articulated self-retaining retractor	23
Weitlaner	Self-retaining retractor	20
Weitlaner-Wullstein	Self-retaining retractor	20
Wertheimer	Suction tube with finger control	43
Wiet	Fenestrometer	63
	Straight micro scissors	51

Z

Zimmermann	Blunt eyes suction tube	82
Zini	Mirror	57

Manufacturers :



Integra MicroFrance SAS (France)
Le Pavillon ■ 03160 Saint Aubin le Monial ■ France



Integra York PA, Inc
589 Davies Drive
York, PA 17402 ■ USA



Integra LifeSciences Sciences (France) SAS
Immeuble Séquoïa 2
97 Allée Alexandre Borodine
Parc Technologique de la Porte des Alpes
69800 Saint Priest ■ France
Tél. : +33 (0)4 37 47 59 00 ■ Fax : +33 (0)4 37 47 59 30



FFDM - Pneumat
78/80 Avenue de la Prospective
18020 Bourges ■ France



Hager & Meisinger GmbH
Hansenmannstrasse 10
D- 41468 Neuss ■ Allemagne



Swann Morton Ltd
Penn Works ■ Owlerton Green ■ Sheffield
South Yorkshire S6 2BJ ■ Royaume Uni



Unimed SA
Rue du Grand-Pré 10
1007 Lausanne ■ Suisse

Manufacturers with CE Class I products only



Agencinox
Zone Industrielle
89110 Aillant sur Tholon ■ France



Concorde Import Export
B.P. 37
92300 Levallois-Perret ■ France



Chemische Fabrik Dr. Weigert GmbH & Co.
Mühlenhagen
D-20539 Hamburg ■ Allemagne

Availability of these products might vary from a given country or region to another, as a result of specific local regulatory approval or clearance requirements for sale in such country or region.

- Consult product labels and inserts for any indications, contraindications, hazards, warnings, precautions, and instructions for use.
- Non contractual document. The manufacturer reserves the right, without prior notice, to modify the products in order to improve their quality.
- Warning: Applicable laws restrict these products to sale by or on the order of a physician.

Additional information for EMEA Customers only :

Products mentioned in this document are CE class I, Im, IIa or IIb devices. Contact Integra should you need any additional information on devices classification. All the medical devices mentioned on this document are CE marked according to European council directive 93/42/EEC on medical devices and its relatives. References that are not medical devices are identified with the indication "NOT A MEDICAL DEVICE".

Products marked with the symbol ^(®) are distributed by Integra MicroFrance SAS (France)

Date of last révision : 12/2017

For more information, please contact customer service :

Europe, Middle-East, Africa

International : +33 (0) 437 47 59 50 ■ +33 (0) 437 47 59 25 (Fax) ■ csemea@integralife.com
France : +33 (0) 437 47 59 10 ■ +33 (0) 437 47 59 29 (Fax) ■ custsvcfrence@integralife.com
United Kingdom : +44 (0) 1264 345 780 ■ +44 (0) 1264 363 782 (Fax) ■ custsvcs.uk@integralife.com
Germany : +49 (0) 2102 5535 6200 ■ +49 (0) 2102 5536 636 (Fax) ■ custsvcgermany@integralife.com
Benelux : +32 (0)2 257 4130 ■ +32 (0)2 253 2466 (Fax) ■ custsvcbenelux@integralife.com
Italy : +39 (0)2 577 8921 ■ +39 (0)2 575 113 71 (Fax) ■ custsvcity@integralife.com
integralife.eu/contact

Integra and the Integra logo are registered trademarks of Integra LifeSciences Corporation or its subsidiaries in the United States and/or other countries.

MicroFrance is a trademark of Integra LifeSciences Corporation or its subsidiaries.

All other trademarks and product names are the property of their respective owners.

© 2017 Integra LifeSciences Corporation. All rights reserved.

0328571-2-EN

DOCUMENT FOR USE IN EUROPE, MIDDLE-EAST AND AFRICA ONLY.