

Integra[®] MicroFrance[®]
Integra ENT - Nose catalogue

Table of contents	ii - iii	Curved rasp	39
Ordering and warranty informations	iv	Double-ended rasp, 210 mm	40
Indications / Contraindications	v	Other Rasps	41
Diagnosis	2 - 3	Nasal splint, cartilage template	42
Air bag	2	Caliper, Crushing press, Perforator bone forceps	43
Angled probe caustic holder	3	Punch rongeur forceps	44
Blunt hook	3	Double-action rongeur	45
Cotton carrier	3	Rongeur	46
Diagnostic device	2	Septum forceps, double-action rongeur	47
Electrode Cautery	2	Double-action bone scissors, bone rongeur	48
Eustachian catheter probe	2	Septum forceps	49
Screws speculum	2	Small scissors, pointed blades, matt finish	50
Spring speculum	2	Small scissors, pointed blades	51
Speculum with handle	4 - 6	Long scissors, pointed blades	52
Speculum with handle - Fiberoptic	7	Small scissors, blunt blades, matt finish	53
Other speculum with handle	8	Small scissors, blunt blades	54
Flexible tension arm	9	Long scissors, blunt blades	55
Angled dissecting forceps	10	Long scissors, blunt blades, shiny finish	56
Angled forceps	11 - 12	Small Metzenbaum scissors, matt finish	57
Syringe	13	Mayo scissors, beveled blades, matt finish	58
Elevator, raspatory	14 - 15	Angled scissors, dorsal scissors, lower lateral scissors	59
Suction tube elevator	16 - 17	Dorsal scissors, shiny finish	60
Scalpel	18	Dural scissors - Scissors, serrated blades	61
Knife	19	Fine dissecting forceps	62
Raspatory	20 - 21	Adson dissecting forceps	63
Retractor	22 - 27	Medium dissecting forceps	64 - 65
Curette	28 - 29	Dissecting forceps, 180mm	66 - 67
Mallet	30 - 31	Dissecting forceps, 200mm	68
Chisel - Gouge	32	Medium bipolar dissecting forceps	69
Osteotome	33	Medium monopolar dissecting forceps	70
Guarded osteotome	34	Tungsten needle-holder	71
Double guarded osteotome	35	Fine haemostatic forceps	72
Fine osteotome	36		
Other osteotome	37		
Straight rasp	38		

Medium haemostatic forceps	73	Micro thru-cutting forceps	101
Haemostatic forceps, serrated jaws - Towel clamp - Forceps with teeth	74	Micro fine punch cutting forceps	102
Strong towel clamp, forceps with teeth	75	Cutting punch forceps, clean-bite forceps, Thrubite forceps	103
Suction tube with finger control	76 - 77	Micro punch rongeur	104
Micro suction tube - adapters	78	Nasal sinus scissors - Scissors, serrated blades	106
Blunt suction tube	79 - 80	Clip applicator	107
Frazier suction irrigation system	81	Micro bipolar forceps	108
Dessi electric irrigation pump	82	Micro bipolar forceps with suction	109
Electric irrigation pump	82	Micro monopolar instruments	110
Irrigation tubing	82	Lemoine , Klossek, Kennedy instruments	111
Sleeve for telescope	82	Vaughan Instruments	112
Irrigation tube, trocar	83	Parsons Instruments	113
Displacer elevator	84	Duncavage Instruments	114
Seeker, pick	85	Levine orbital instrumentation	115
Knife - Elevator	86	Wormald frontal instrumentation	116
Dacryocystorhinostomy	86	Wormald skull base instrumentation	117
Diamond knife	86	Stamm skull base instrumentation	119
Dissector and knife	86	Sterilization case, tray, cup, Surgical oil	120
Knife	86	Plastic sterilization case	121
Sickle knife	86	Numerical index	123
Fenestrated cup forceps	87	Table for corresponding manufacturer part numbers For information purposes only	131
De Gabory cup forceps	88	Global alphabetical index	133
Jankowski cup forceps	89	Alphabetical index Search by name	139
Rouvier cup forceps	90		
Takahashi cup forceps	91		
Weil-Blakesley cup forceps	92		
Pediatric cup forceps	93		
Fenestrated cup forceps	94		
Cup forceps, curved down	95		
Biopsy and grasping forceps, Frontal sinus recess forceps, Cup forceps	96		
Biopsy forceps	97		
Backbiting punch forceps	98		
Pediatric backbiting punch forceps	99		
Micro punch forceps	100		

Pricing :

Prices stated in specific written quotations are firm for thirty days from the date given, and are otherwise subject to change without prior notice. Pricing terms stated on written agreements are governed by such agreements.

Minimum Order Requirements :

The minimum ordering amount is €250 (Integra reserves the right to apply €20 handling fees and transport fees for any order below €250). For partial unit orders, please contact the customer service to obtain a quote.

Administrative fees :

Administrative fees may be charged for any order.

Ordering Procedure :

A written purchase order is required for the purchase of Integra MicroFrance® products.

Acceptance of Orders :

Orders are accepted upon approval by Integra Customer Service.

Return Policy :

- Authorization from Customer Service must be obtained prior to returning product.
- Sterile product must be returned in unopened, undamaged cartons, packed to prevent damage.
- Non-sterile product must be returned in unused saleable condition in original package.
- No credit will be issued for special orders.
- A credit note will be issued for products returned less than ninety days from shipment date with a 20% restocking fee, provided that the product being returned is not damaged and it is possible to verify that the product has not been used or opened.

Integra Limited Warranty

Please refer to the warranty included in the packaging of each product to know the applicable warranty.

Contacts Customer service :

International

+33 (0) 4 37 47 59 50
+33 (0) 4 37 47 59 25 (fax)
csemea@integralife.com

France

+33 (0) 4 37 47 59 10
+33 (0) 4 37 47 59 29 (Fax)
custsvcfrence@integralife.com

Benelux

+32 (0) 2 257 4130
+32 (0) 2 253 2466 (Fax)
custsvcbenelux@integralife.com

United Kingdom

+44 (0) 1264 312 780
+44 (0) 1264 363 782 (Fax)
custsvcs.uk@integralife.com

Germany

+49 (0) 2102 5535 6200
+49 (0) 2102 5536 636 (Fax)
custsvcgermany@integralife.com

Italy

+39 (0) 2 577 8921
+39 (0) 2 575 113 71 (Fax)
custsvcitaly@integralife.com

MicroFrance® ENT Instrumentation

INDICATIONS

- All the medical devices showed in this catalogue have indications for diagnosis and/or ENT surgery.
- Sizes are not contractual and are given for information purposes only.

CONTRAINDICATIONS

- Do not use in indications other than the indications mentioned in the DFU or Labeling.

How to read the catalogue

Diagnosis

INTEGRA

Detail view of the instrument

Instrument to a 1/1 scale except mentioned otherwise

Explanatory table see below

Blunt hook 90°	Blunt hook 45°	Cotton carrier/twist end	Angled probe caustic holder
160mm	160mm	120mm	120mm
MCO805	MCO807	7719-2	7731
2mm	1mm	Ø 1,2mm	working length 80mm

DOCUMENT FOR USE IN EUROPE, MIDDLE-EAST AND AFRICA ONLY.

Explanation of the table reference and complementary product description

Title or subtitles	
global complementary description	
Product Ref.1	complementary description1
Product Ref.2	complementary description2

Electrode cautery



Eustachian catheter probe



Spring speculum, screws speculum

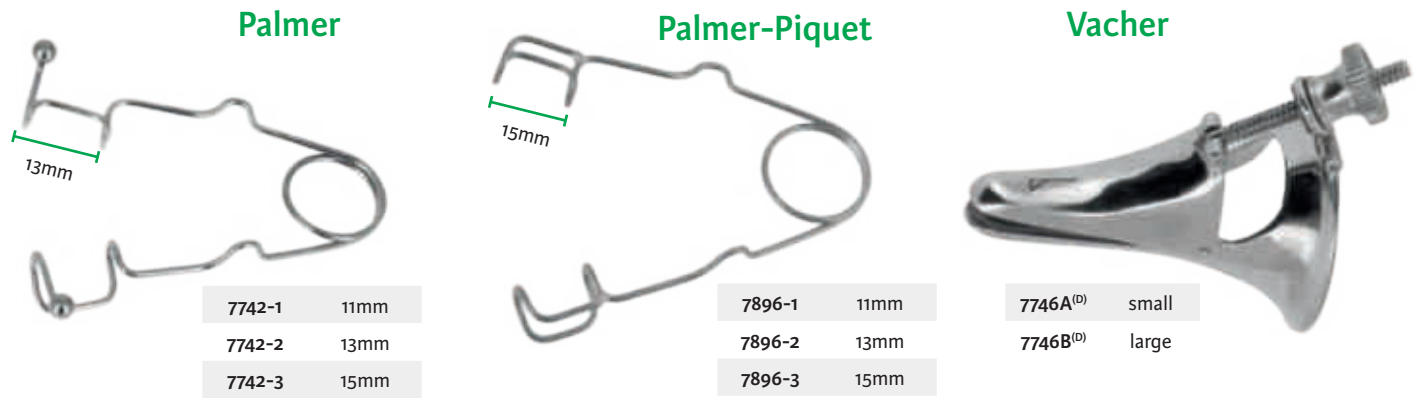

Diagnostic device



Air bag



^(D) Distributed by Integra MicroFrance SAS (France) - For corresponding manufacturer part numbers, see table in annex

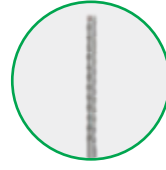
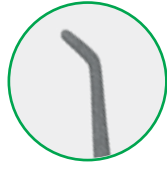

Marquet

Legent



Blunt hook
90°

Blunt hook
45°

Cotton carrier, twist end
15mm

Angled probe caustic
holder

165mm

165mm

140mm

110mm

MCO805

MCO805A

MCO950

MCO807

7719-2

7731

2mm

2.5mm

0.8mm

1mm

Ø 1.2mm

working length 80mm

Hartmann



160mm

7898

Tieck-Halle



130mm

7897

Beckman



140mm

7899

Left hand

Vienna



140mm

MCO233

Dilatator



140mm

MCO237

Self-retaining
Serrated blades



3714199

Vienna

130mm

3714199	Blades 23mm
3714200	Blades 28mm
3714201	Blades 30mm



150mm - left hand

3714204	Blades 25mm n° 1	small
---------	------------------	-------

Tieck

140mm

3714203 Blades 18mm



Vienna

140mm

3714476 Blades 30mm



Vienna modified

140mm

3714479 Blades 30mm





Self-retaining speculum with fiber optic - Fiberoptic 220cm - Adapters



Adapters	for generator	for instrument
Wolf	MCL170 ^{(D)(t)}	MCL171 ^{(D)(t)}
Storz	MCL173 ^{(D)(t)}	MCL174 ^{(D)(t)}
Olympus	MCL197 ^{(D)(t)}	

^(t) Not a medical device

^(D) Distributed by Integra MicroFrance SAS (France) - For corresponding manufacturer part numbers, see table in annex

Killian

135mm - non self-retaining

3714205 Blades 50mm



Cottle

130mm - Tapered blades

3714213 70mm 10-8mm



Cottle

135mm - Thin blades

3714472 50mm



140mm - Ebony finish

3714480 Blades 35mm

3714481 Blades 50mm

3714482 Blades 75mm



3714481

Legent



Complete flexible tension arm

MCO980

Delivered with MCO981, MCO982 et MCO983

Darrouzet

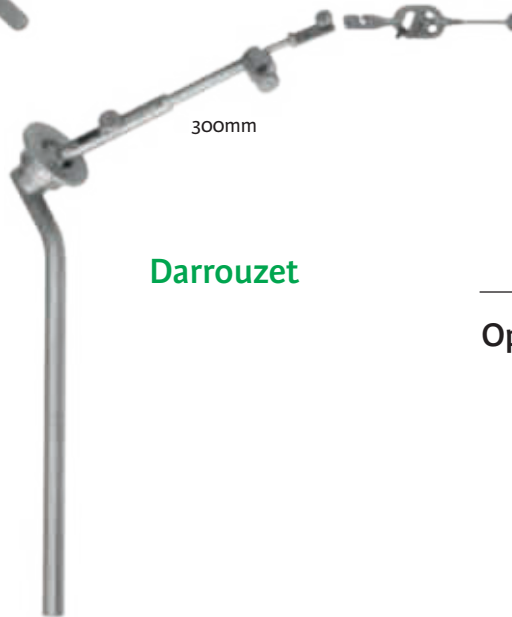

Complete flexible tension arm

MCO978

Delivered with MCO978S

Flexible tension arm

Operating room table clamp



CEV984

CEV985

Accessories for flexible tension arm

Ear quick-lock speculum

Nasal speculum holder

Articulated kneecap

Malleable blade

Self-retaining specula



MCO981

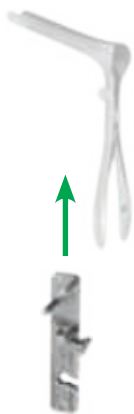

MCO982



MCO983-4



MCO983

Devèze



MCO981D



MCO978S



200mm

9511007

smooth jaws 2x18mm

Lucae



7726MF

150mm

7726MF

7727

7728

serrated jaws 1x12mm

spoon jaws

with teeth

Politzer



7732-1

120mm

7732-1

7733

7734

serrated jaws
1,5x14mm

spoon
jaws

with
teeth

Scale 1/2

Angled forceps

Serrated jaws

Rouvier **Pradès**



MCEN18

MCEN19

3x8mm

0.9x7mm



MCEN18

100mm

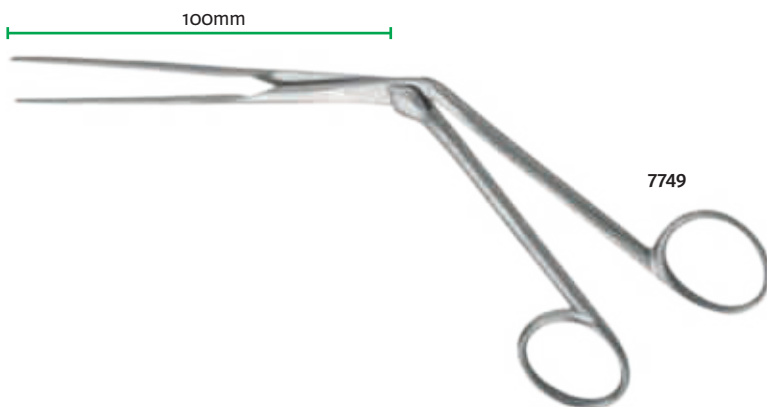

7749

Lubet-Barbon

Jaws 60mm

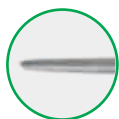

7749

7750

smooth jaws

serrated jaws

Spoon jaws forceps

Brünings

Spoon jaws

Fenestrated spoon jaws



7761-1

7761-2

7761B-1

7761B-2

7.5mm

9.5mm

7.5mm

9.5mm

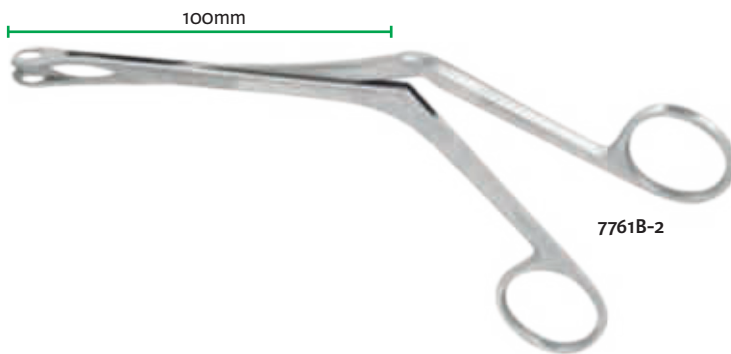

7761B-2

100mm

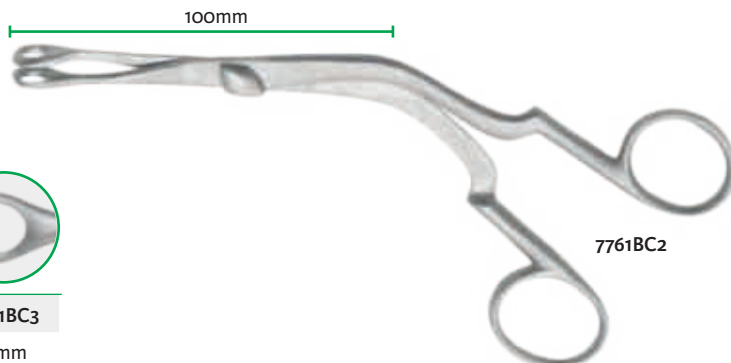

7761BC2

Luc

Spoon jaws

Fenestrated spoon jaws

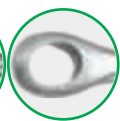
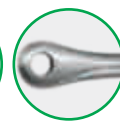

7761C1

7761C2

7761C3

7761BC1

7761BC2

7761BC3

7mm

9mm

11mm

7mm

9mm

11mm

Watson-William



Spoon jaws		
3711105	9.5x13mm	N° 2

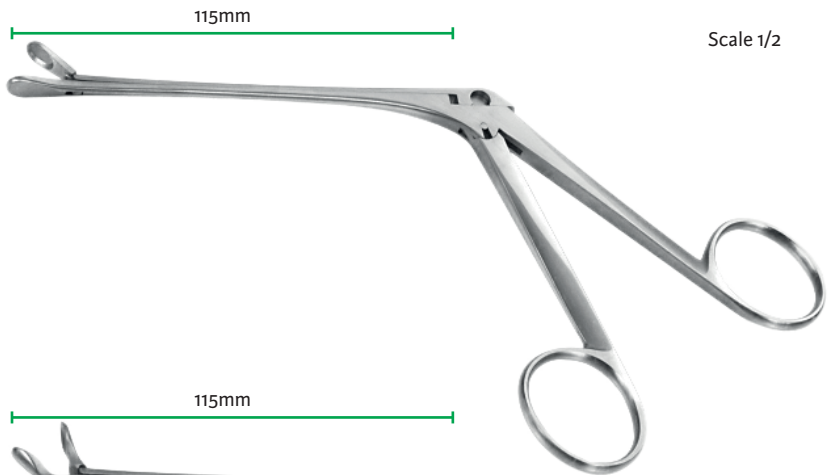

Scale 1/2

Weil



Spoon jaws		
3711014	5x8.5mm	45°

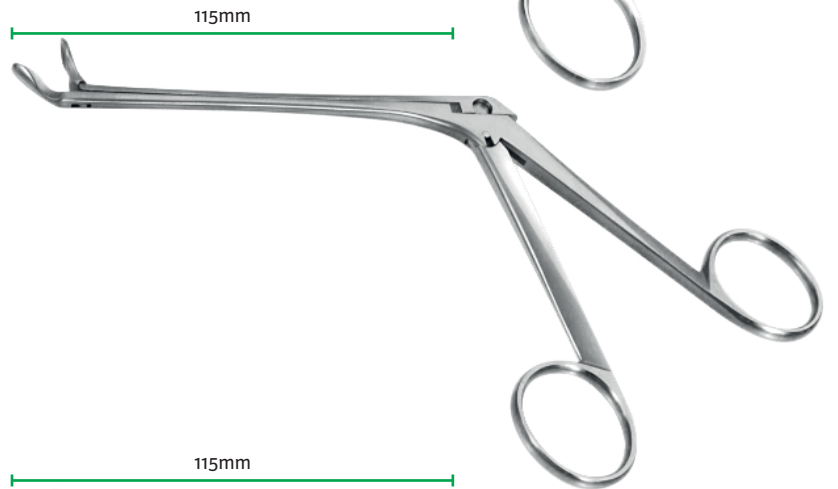

Lewis



Fenestrated spoon jaws		
3711022	à gauche	11mm

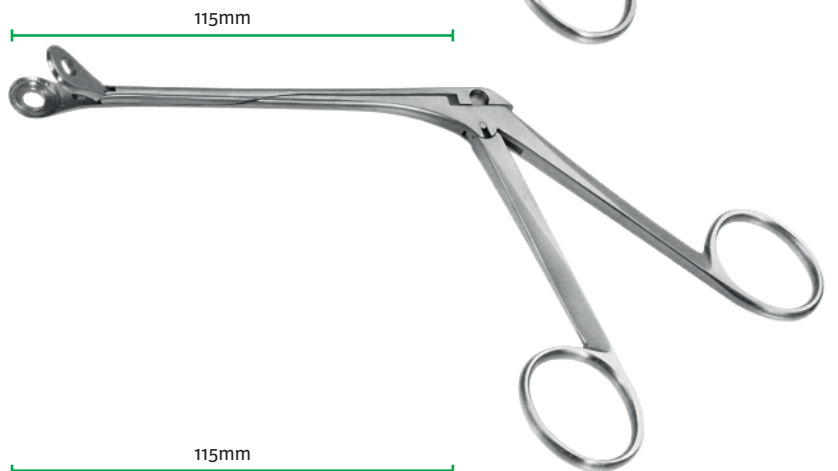

Blakesley



Serrated jaws		
3711108	6.6x14mm	

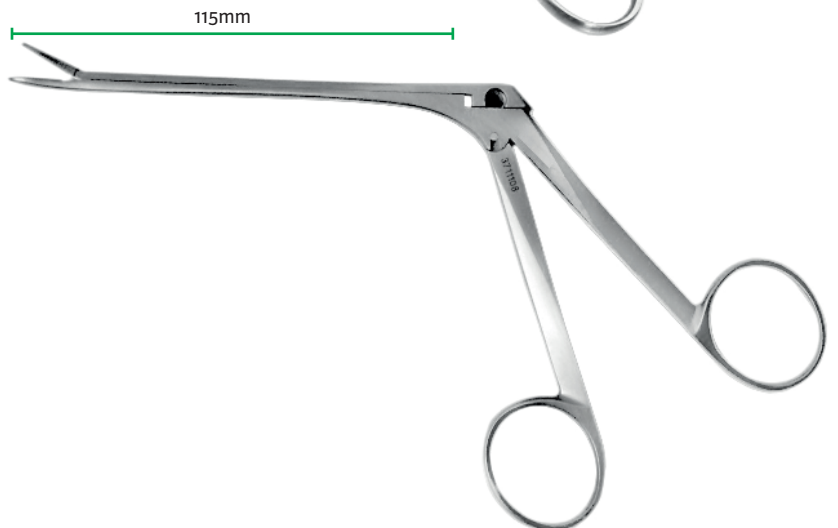

Syringe

Génia

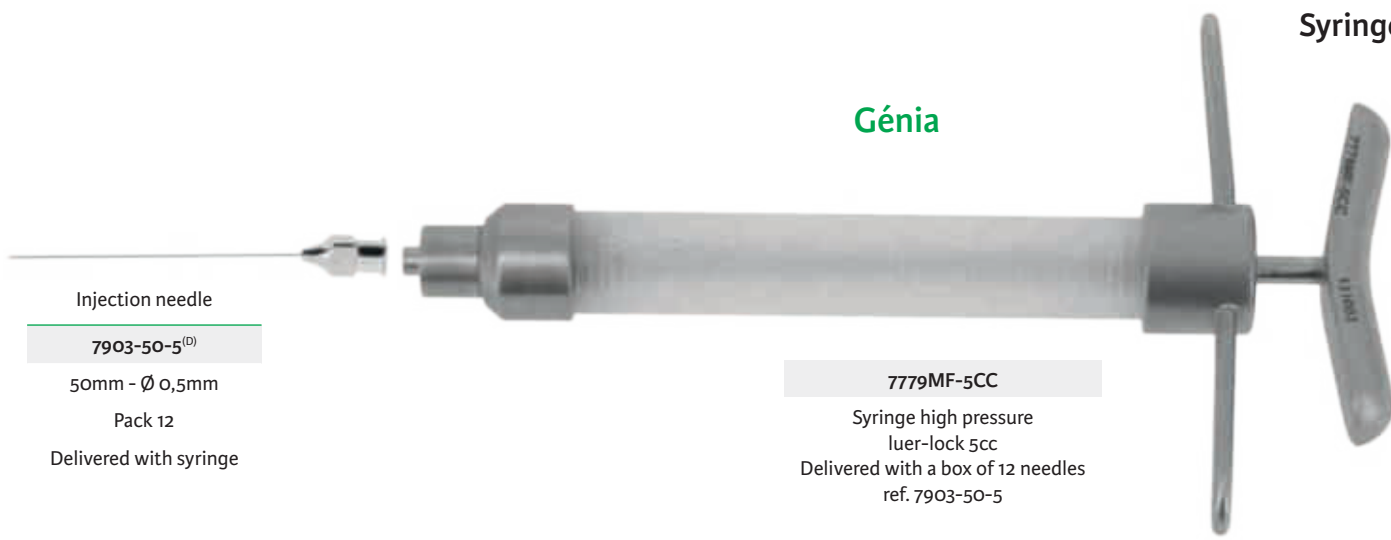

Injection needle

7903-50-5^(D)

50mm - Ø 0,5mm

Pack 12

Delivered with syringe

7779MF-5CC

Syringe high pressure
luer-lock 5cc
Delivered with a box of 12 needles
ref. 7903-50-5

Grey washer luer

Replacement tube

White washer piston



7779MF-2

Pack 6



7779MF-3



7779MF-1

Pack 6

Pushing syringe

7783-12

Pack 2



Chouard

for syringe, single use, luer-lock 12cc



Injection needle



7903-50-5^(D)

50mm - Ø 0,5mm

Pack 12

for syringe 7779MF-5CC

^(D) Distributed by Integra MicroFrance SAS (France) - For corresponding manufacturer part numbers, see table in annex

Sébileau



190mm

CP985

5mm

Fleury



180mm

MCO305

8,5mm

Freer



160mm

MCO803

2,5mm

Howarth



185mm

CP611

5mm



220mm

CP625

Cottle



220mm
CP626

McKenty



240mm
CP627

Freer



180mm
3714038
4,5mm

Woodson



200mm
3714040
10° / 30°

Dingmann



180mm
3714660
4 and 6mm

Rouvier

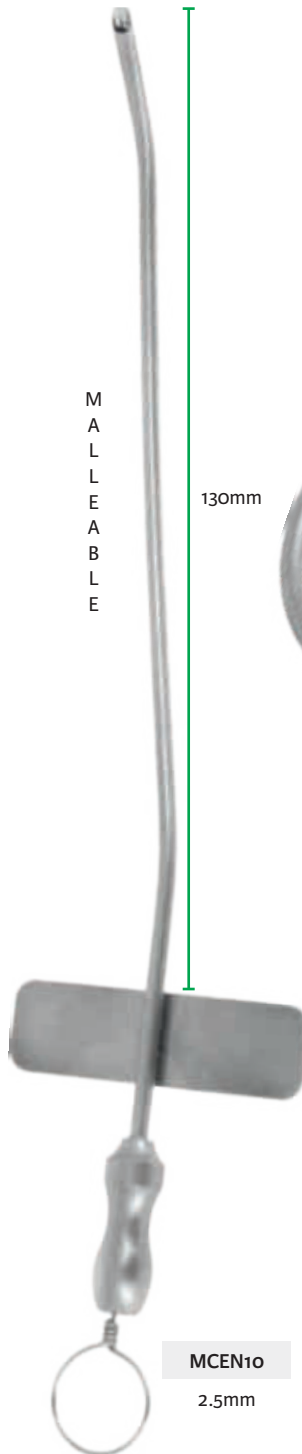

Orsel

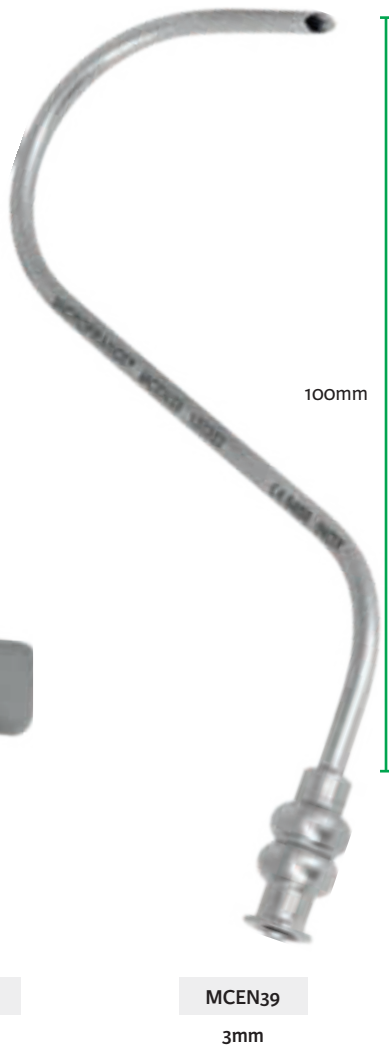

Orsel

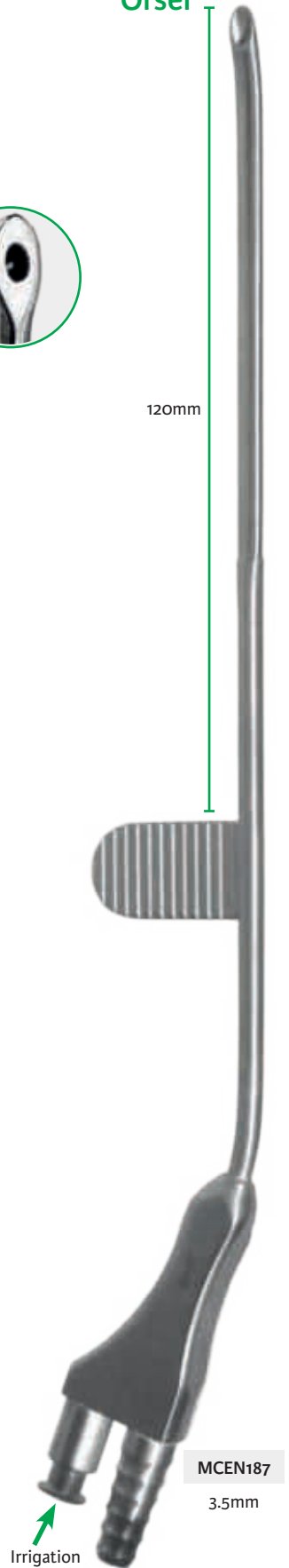

Toriumi



80mm

190mm
with finger control 3.5mm

CP1102

sharp

CP1103

blunt

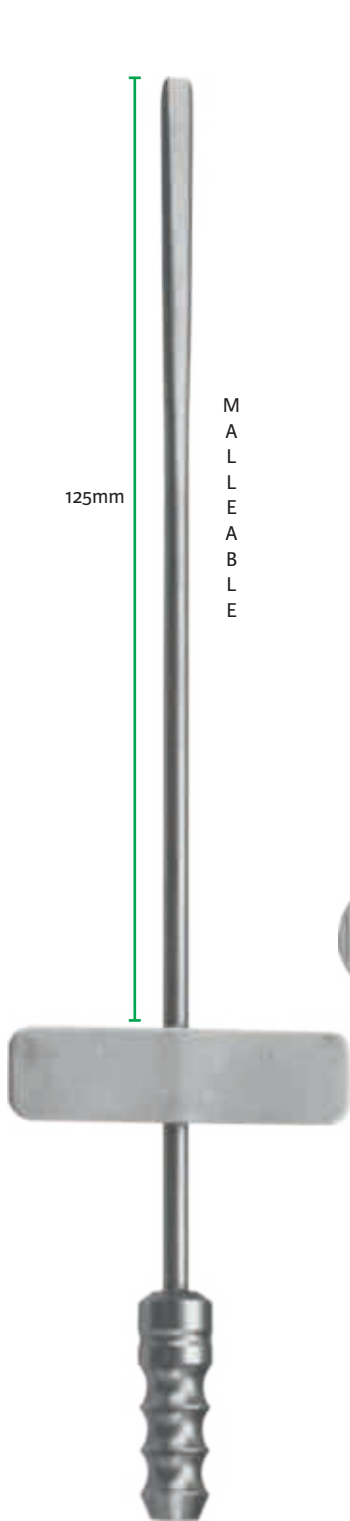

125mm

M
A
L
L
E
A
B
L
E

CP337

3mm

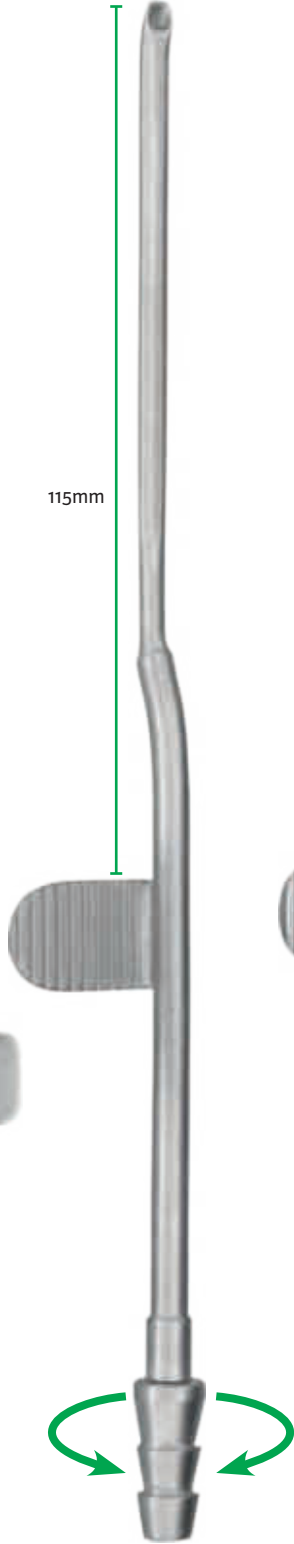

115mm

SCP337A

3.5mm

Guillen



110mm

Bayonet

CP337-1

5mm

Gorney



220mm

3714383

3mm



120mm

1003IG^(D)

N° 3



160mm

1005I^(D)

N° 7



200mm

1003LI^(D)

N° 3L



150mm

CP821



120mm

1004IG^(D)

N° 4

blades 23

use with blades 11/15

^(D) Distributed by Integra MicroFrance SAS (France) - For corresponding manufacturer part numbers, see table in annex

Ballenger



200mm	
CP622-4	4mm
215mm	
3714164	3mm
3714166	5mm

Joseph



160mm	
CP333	angled

Cottle



135mm	
3714173	
5mm	

Joseph



160mm	
3714678	
7mm	

Farabeuf

Fleury

Sébileau

Plester

Lempert



150mm

7787-10

10mm



170mm

MCO979

6,5mm



150mm

CP825

4mm



180mm

MCO988

7,5mm



185mm

3724060

7mm



195mm

3724059

6,5mm

Joseph



180mm

CP310

5mm

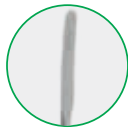

180mm

CP310D

5mm
Straight

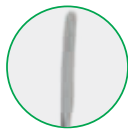

180mm

CP310E

4mm

CP310

Obwegeser



Obwegeser

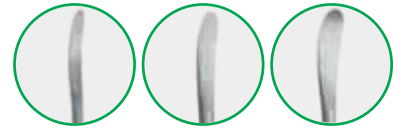

180mm

CP344A

5mm

CP344B

7mm

CP344C

11mm

Obwegeser-Tessier

180mm - sharp

CP344AT

5mm

CP344BT

7mm

CP344CT

11mm

Obwegeser



190mm

CP344D

7mm
Curved

CP344E

7mm
Very curved

Obwegeser-Tessier

190mm - sharp

CP344DT

7mm
Curved

CP344ET

7mm
Very curved

CP344A

Farabeuf



140mm 120mm
7768-1 7768
pair pair

Desmarres



140mm
CP822-12
12mm
CP822-10
10mm
CP822-14
14mm

Gillies



180mm
CP17
3mm
CP17-1
2mm

Gillies



145mm
CP17-3
2mm
CP17-2
3mm



145mm
CP628
5mm

Humby



110mm
CP941
articulated

Joseph



160mm
3714019
4mm

Kleinert-Kutz



160mm
3714024 3mm
3714025 5mm
3714026 7mm

Cottle



145mm
3714107 4mm
very curved
3714108 4mm
3714109 5mm

Sisson



150mm
3714111
6mm

Converse



180mm
3714364 2,5mm

Frazier



130mm
3724256
3,5mm

Knapp



150mm

3714027

8mm

3714028

blunt

Volkmann



140mm

CP21-3

sharp

CP21A-3

blunt



150mm

7782-1-2



180mm

CP335



160mm

CP609

3 sharp prongs

80mm
CP340

Claoué



110mm
CP341

Converse



95mm
CP331 CP331-1
sharp blunt

Kilner



110mm
3714179

Converse



125mm
CP803

Jost



120mm
CP338



130mm
CP339



Aufricht



170mm
CP306 45mm

Cottle



130mm
3714187

Cottle



130mm
3714182 Right tip sharp, left ball tip
3714183 Left tip sharp, right ball tip

Joseph



160mm
3714020 skin hook

- 3714020 2mm
- 3714021 5mm
- 3714023 10mm

Joseph



160mm
CP23-10 10mm

- CP23-4 4mm
- CP23-6 6mm
- CP23-8 8mm
- CP23A-8 8mm mousse
- CP23-10 10mm



220mm

CP630

with loop
and ball

Ragnell



160mm

CP632

Dufourmentel



170mm

CP947



Lima

Frèche

Jankowski

Klosssek

M
A
L
L
E
A
B
L
E

M
A
L
L
E
A
B
L
E

2,2mm

2mm

2,2mm

5mm

250mm

774

4x6mm

220mm

MCEN104

6x8mm

220mm

MCEN109

4x6mm
including bent tool

200mm

MCEN106

200mm

MCEN107

Straight curette

Scale 1/1



CP302-6

Volkmann

170mm

0	CP302-2	2mm	0	CP302-4	4mm	0	CP302-6	6mm
0	CP302-3	3mm	0	CP302-5	5mm	0	CP302-8	8mm

Curette coudée - Curette courbe

Scale 2/3

Antrum angled - 195mm

3714223	2,5x6mm
3714224	4x10mm



Frontal sinus curved 45° - 195mm

3714229	2,5x6mm
---------	---------



Frontal sinus curved 90° - 195mm

3714230	2,5x6mm
---------	---------



Frontal sinus curved 75° - 190mm

3714284	3,5x7,5mm
---------	-----------



Frontal sinus curved 100° - 190mm

3714285	3,5x7,5mm
---------	-----------



Antrum curved fenestrated - 190mm - forward cutting

3714317	6x7mm
---------	-------





165mm - 110g

MCO995



Lombard

185mm - 330g

7766



180mm - 200g

CP907

1 teflon head



180mm - 230g

CP300

Jost

Ballenger

Metzenbaum

Fleury



Chisel

Gouge

Straight

Straight 'V' shaped

Bayonet

Bayonet 'V' shaped

Straight

180mm

150mm

150mm

150mm

150mm

130mm

CP801-7	7mm
CP801-10	10mm

3714055	2mm
3714056	4mm
3714057	6mm
3714058	8mm

3714320	5mm
---------	-----

CP823-5	5mm
---------	-----

CP824-5	5mm
---------	-----

MCO214-13-10	1mm
MCO214-13-20	2mm
MCO214-13-40	4mm
MCO214-13-60	6mm
MCO214-13-80	8mm

Aiach



160mm

CP317

16mm

Pollet-Pech



160mm

CP318

13mm

Rubin



170mm

3714076 14mm

3714077 16mm

Marchac



180mm

CP304-10

Size	Curved	Straight
 2mm	CP304B-2	CP304-2
 3mm	CP304B-3	CP304-3
 4mm	CP304B-4	CP304-4
 5mm	CP304B-5	CP304-5
 6mm	CP304B-6	CP304-6
 7mm	-	CP304-7
 8mm	CP304B-8	CP304-8
 9mm	-	CP304-9
 10mm	CP304B-10	CP304-10
 11mm	-	CP304-11
 12mm	CP304B-12	CP304-12
 14mm	-	CP304-14
 15mm	-	CP304-15
 16mm	-	CP304-16

Tessier

Jost

Marchac

Claoué

Silver



180mm

CP316



180mm

CP802

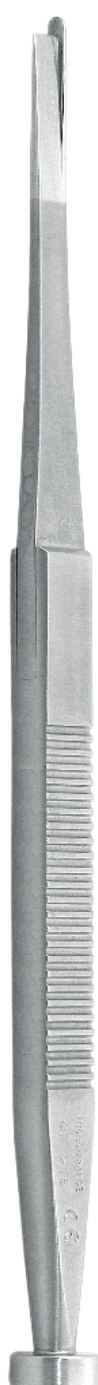

180mm

CP315

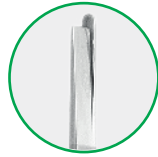

CP315

Pech-Marchac



CP315D

curved right



CP315G

curved left



180mm

CP305



CP305

Lindas

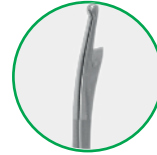

CP305L

curved left



CP305R

curved right



180mm

3714097



3714097



3714098

curved right



3714099

curved left

Mac-Indoe



180mm
CP314-14
14mm

Robin



160mm
CP309-14-16

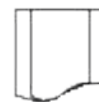

CP309-8-12
8 - 12mm



CP309-10-14
10 - 14mm

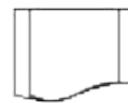

CP309-12-16
12 - 16mm



CP309-14-16
14 - 16mm



CP309-14-18
14 - 18mm

Cottle



195mm
CP808-6
6mm

Cottle



195mm
CP806
6mm

Cottle



190mm
CP807
5mm

Becker

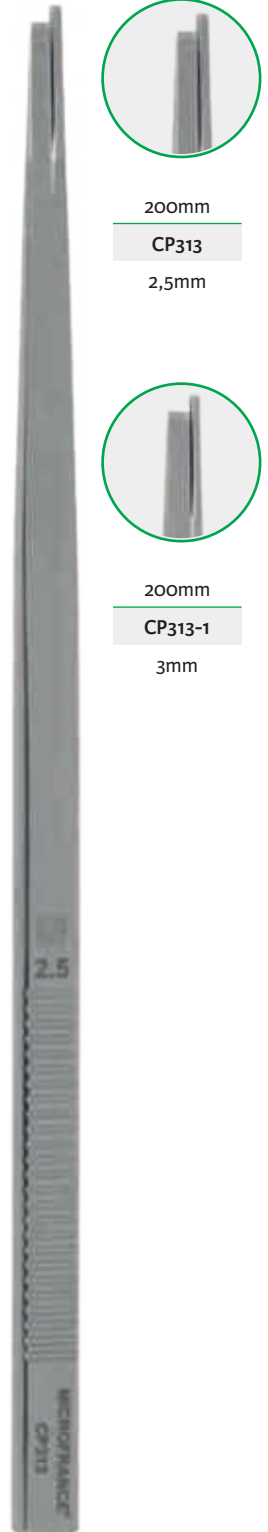

200mm
CP313

Neivert



200mm

3714338

4mm

Parkès



170mm

3714096

4mm



160mm - 5mm

curved, left

3714091

straight, right

3714092



160mm - straight

3714059

2mm

3714060

3mm



210mm

CP904

8x35mm - strong

Maltz



170mm

CP301-1

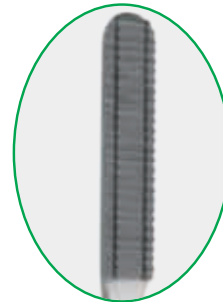

Maltz

CP301-1

8x35mm - downstroke

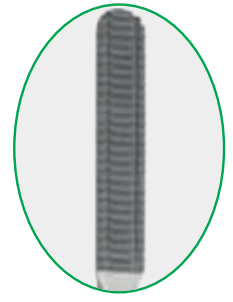

Maltz

CP301

10x45mm - downstroke

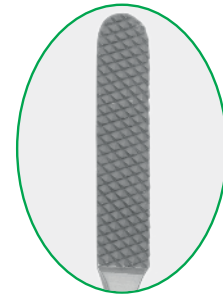

190mm

CP827

10x45mm - downstroke

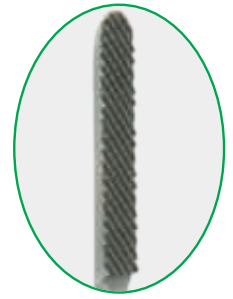

170mm

CP828

8x35mm - downstroke

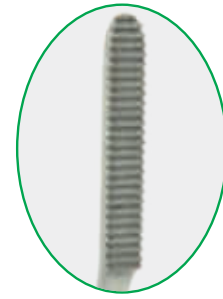

170mm

CP905

8x35mm, downcutting, concave

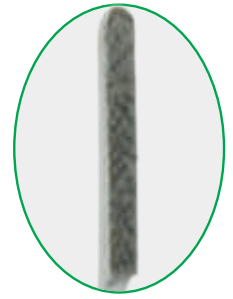

Pech-Cannoni

170mm

CP905-1

7x36mm, coarse concave



170mm

CP978

8x35mm, straight, coarse

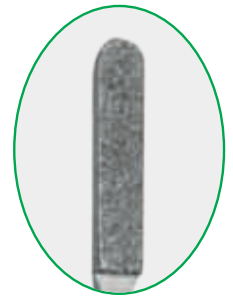

180mm

CP810

8x30mm, straight, diamond

Toriumi



200mm

CP1100

8x8mm

Aufricht

200mm



CP973

8x25mm
downward
cutting



CP974

8x25mm
upward cutting



CP976

8x30mm
bi-directional

Glabella



200mm

3714672

6x10mm
tungsten



200mm

CP291

4x15mm

Bigot



190mm

CP998-1

8x12mm
cross-cutting

Fomon



180mm

CP809

8x30mm
diamond



175mm

CP301-3

7x20mm
concave
downward
cutting

180mm

CP301-2

8x30mm
downward cutting

Becker

Becker

Fomon

Rees

Gorney

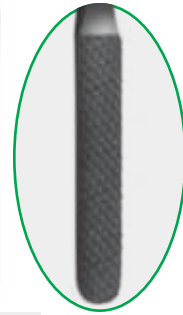

CP301-10

CP1104

CP1105

CP301-4

CP301-5

CP301-9

7x38mm-3/4
Sure-Grip™
tungsten

7x20mm-1/2
Sure-Grip™
tungsten

7x20mm-3/4
Sure-Grip™
tungsten

7x38mm
coarse

7x38mm
coarse

7x12mm
8x22mm

Fomon



210mm

Double-ended
one convex
one flat
coarse teeth

3714149 7mm

fine teeth

3714148 7mm

3714149



210mm

Sure-Grip™ tungsten
fine grit

3714150 1/2

Sure-Grip™ tungsten
coarse grit

3714152 5/6

3714153 7/8

3714152

Wiener



190mm

curved
trocar tip

3714401 5mm

3714401

Aquaplast™ nasal splint

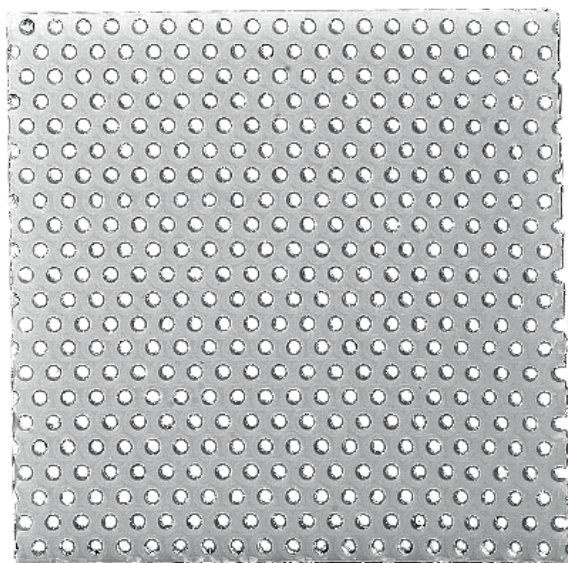

AQ1728^(D)

75x75mm - Pack 10

not sterile, single use

^(D) Distributed by Integra MicroFrance SAS (France)
For corresponding manufacturer part numbers, see table in annex

Cartilage template

Toriumi



CP1109

80x90mm
with graduations

Scale 1/2

Jost



CP814-1

Delivered with key CP814-3



CP814-2

Smooth plate device 30x50mm for CP814-1



CP814-3

Tightening key for CP814-1

Cartilage crushing press

Rubin



3711032

Septum morselizer 190mm
6x11mm jaws

Scale 1/1

Caliper

Castroviejo



90mm

3740009

Scale 1/2

Perforator bone forceps

Stoll



150mm

CP640

Scale 1/2

60mm

Citelli



7764

3mm

100mm

Kerrison-Costen



3712021

4mm

100mm

Kerrison

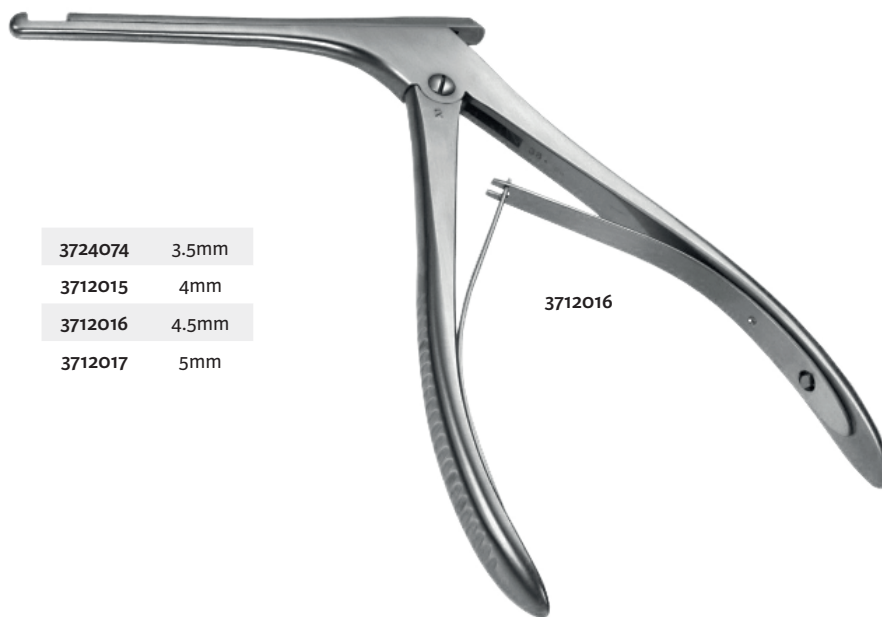

3724074 3.5mm

3712015 4mm

3712016 4.5mm

3712017 5mm

3712016

Beyer



CP380

160mm

CP380	CP380-2
straight jaws 2mm	curved jaws 2mm

Beyer



CP380-3

180mm

CP380-3	CP380-5	CP380-1
curved jaws 2mm	curved jaws 4mm	straight jaws 2mm

Lempert



190mm

3712003	curved jaws	3,5x9mm
3712002	straight jaws	3,5x9mm

Beyer



180mm

3712008	curved jaws 4mm
---------	-----------------

Jansen-Middleton



180mm	
Septum forceps	
3711026	4.5x16mm
3711027	3.5x16mm

Jansen-Middleton



180mm	
Double-action rongeur	
CP621	4x20mm

Double-action bone rongeur

Scale 2/3



Ruskin

160mm

CP381

Double-action bone scissors, serrated blades

Gorney



200mm

3713025

Turbinate

Caplan



180mm

3713063

Becker



160mm

3713020

Septum scissors

Scale 2/3

Martin



240mm

7765

Delivered with 2 jaws

Waksham



230mm

3711029

straight

Offret

Scale 3/4



100mm

CP353

strong curvature



100mm

CP356

Streiff

Joseph

Fox



CP16-1

105mm

CP16-1

CP16

Curved blades

Straight blades



CP919A

110mm

CP919A

CP919

Curved blades

Straight blades



CP358A

110mm

CP358A

CP358

Curved blades

Straight blades

Joseph

Stevens

Kilner-jost



CP354A



135mm - shiny finish

3713012

Curved blades



120mm - matt finish

CP362

Curved

120mm - matt finish

CP354A

CP354

Curved blades

Straight blades

Boetcher



180mm

CP997

Curved

Brophy



CP367-1

150mm

CP367-1

Curved

CP367

Straight

Joseph



CP355A

150mm

CP355A

Curved

CP355

Straight

Bregeat

Stevens

Stevens



110mm
CP363
Curved blades



110mm - Tenotomy scissors
CP922
Straight blades



110mm - Tenotomy scissors
CP922A
Curved blades

Stevens

shiny finish



110mm - Tenotomy scissors

3713013

Straight blades

Stevens

matt finish



115mm - Tenotomy scissors

CP922B

Curved blades

Shea

matt finish



120mm

CP637

Curved blades

Ragnell



150mm

CP616-15

Léger



150mm

CP365

Reynolds



160mm

CP921

Joseph



150mm

CP355C

130mm

CP616-13

Fomon

130mm

3713024

Curved blunt blades



Fomon

130mm - sabre back blades

3713001 Tungsten curved blades



Fomon

140mm

3713059

Curved bayonet blades



Metzenbaum



110mm

CP351-7	CP351-6
Curved blades	Straight blades

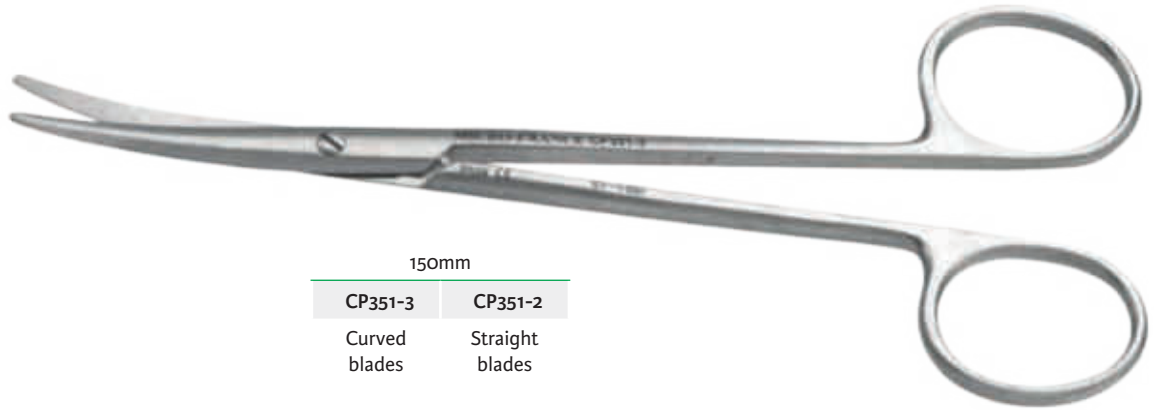

150mm

CP351-3	CP351-2
Curved blades	Straight blades

Delicate curved scissors



150mm

CP931-1	CP931
Curved blades	Straight blades

Mayo



Becker-Converse

100mm
CP1106
Angled scissors
serrated blades



Converse

100mm
CP348
Angled scissors



Fomon



140mm
CP612
lower lateral scissors
very curved

Cottle



Cottle-Pech

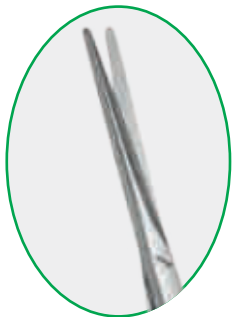

140mm
CP635
dorsal scissors

Fomon



140mm
CP613
dorsal scissors - blunt tip

Pellegrini



150mm
CP359
dorsal scissors
serrated blades



150mm
CP614
dorsal scissors

Cottle

160mm

3713002

1 serrated blade



**Fomon
supercut™**

145mm

3741154

blunt blades



Dural scissors, shiny finish

Knight

170mm

3713054

standard blades



Heymann-Klossek

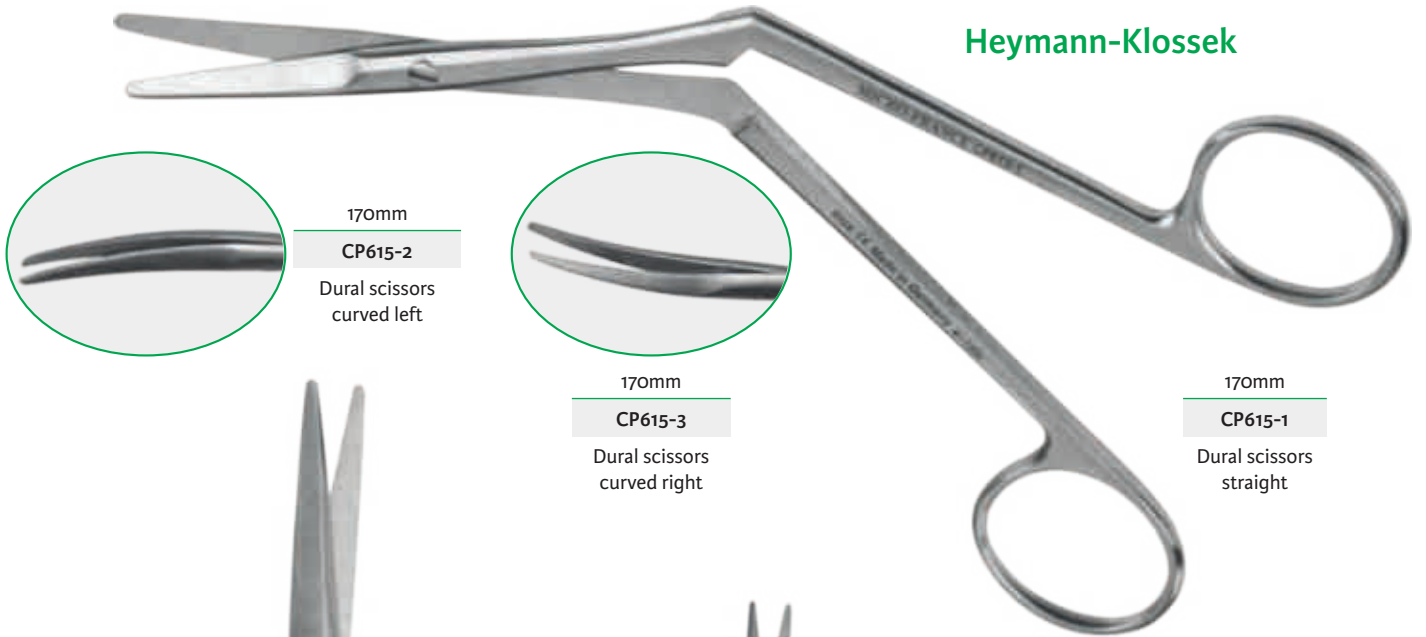

170mm
CP615-2
Dural scissors
curved left

170mm
CP615-3
Dural scissors
curved right

170mm
CP615-1
Dural scissors
straight

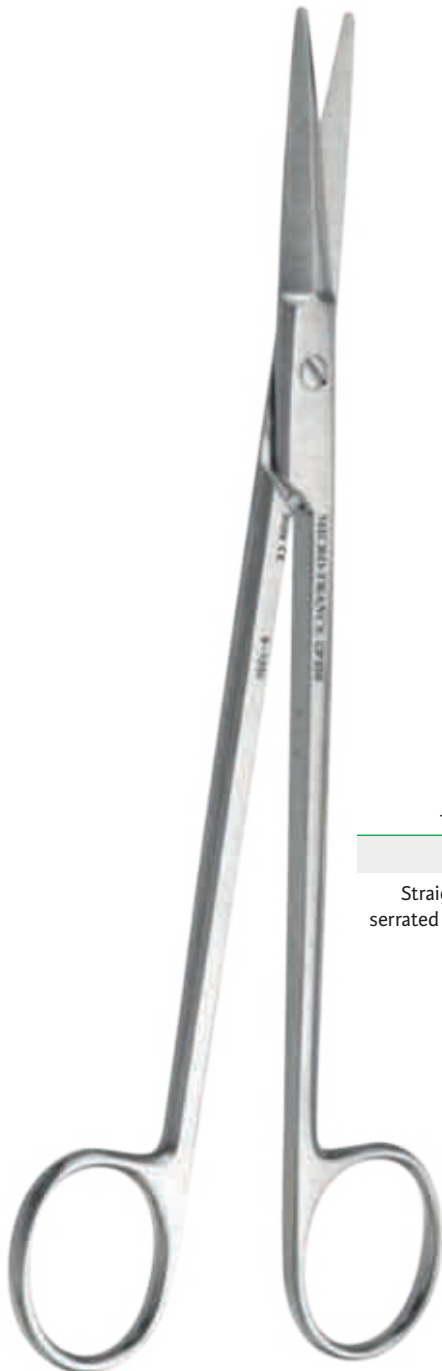

180mm
CP350
Straight scissors
serrated bayonet blades

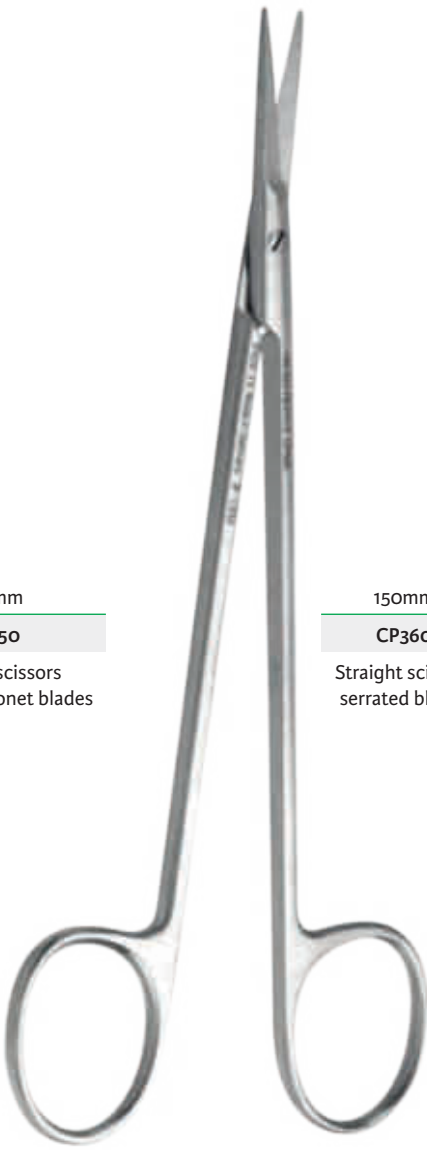

150mm
CP360
Straight scissors
serrated blades

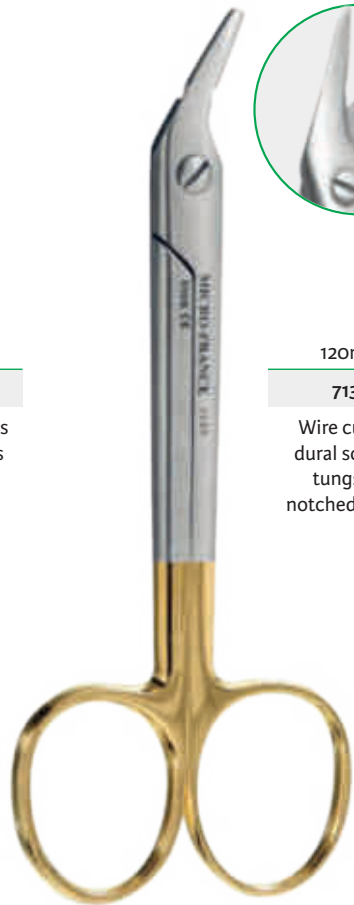

120mm
713T
Wire cutting
dural scissors
tungsten
notched blades

Bebee

Dissecting forceps 110mm

Castroviejo



CP938-1

Horizontal teeth and platform

Castroviejo



CP37

Oblique teeth and platform



CP332

Serrated jaws 1.4mm

Dissecting forceps 120mm



CP414

Jaws 1mm



Serrated jaws

7831A-12

Jaws 1.5mm



3740012

Jaws 3mm



CP406

Jaws 1mm



Jaws with teeth

7833A-12

Jaws 1.5mm



CP400-1

5x5 teeth

150mm

Adson



- CP604-15 Serrated jaws 1.5mm
- CP605-15 1x2 teeth jaws 1.5mm

Adson-Brown



- CP606-15 7x7 teeth

120mm



Adson-Tubiana

Jaws 1mm

Adson

Jaws 1,5mm

Jaws 2mm

Jaws 1,5mm

Adson-Brown

Jaws with 7x7 teeth

M832	M833	CP604	CP605	3740028	CP606A	CP606	3740038
serrated jaws	1x2 teeth	serrated jaws	1x2 teeth	2x3 teeth	tungsten serrated jaws		angled jaws

Mac-Indoe

140mm



CP934

Oblique teeth and serrated platform



CP934-1

Serrated jaws

Debakey

Barraya

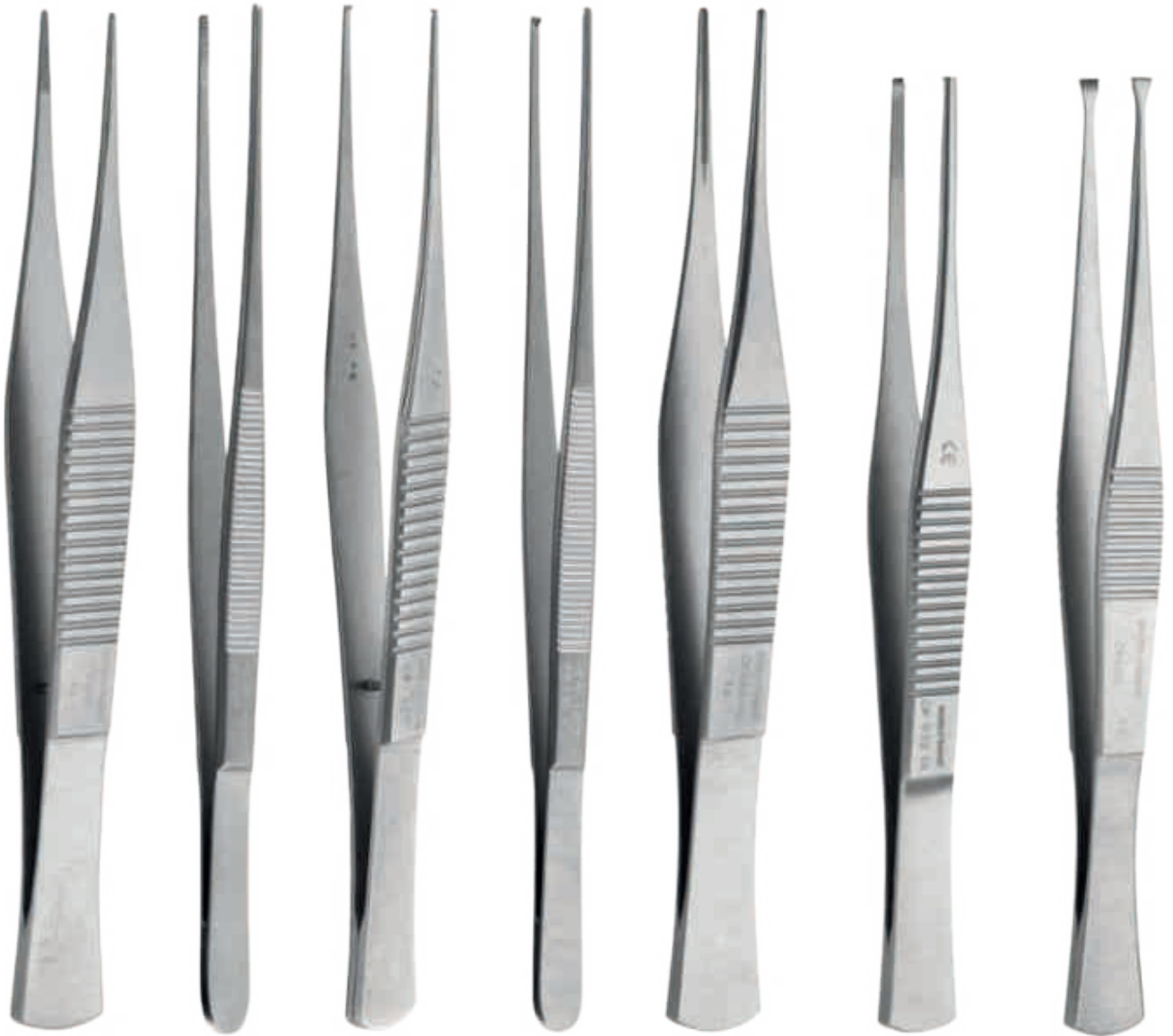

150mm

140mm

CP415	7831A-15	CP407	7833A-15	CP988-15	CP933-14	CP400
Serrated jaws 1mm	Serrated jaws 1.5mm	1x2 teeth jaws 1mm	1x2 teeth jaws 1.5mm	Serrated jaws 1.5mm	3x4 teeth and serrated platform	5x5 teeth

Cottle



110mm

3740067

Columella forceps
Jaws 14mm

Graefe



3740049

Forceps with lock Jaws
4.5mm

Mac-Indoe

Précelle



150mm

CP345

serrated angled jaws



150mm

3740015

serrated jaws 3mm



150mm

3740019

3mm - 1x2 teeth

Barraya



160mm

CP933-16

3x4 teeth and
serrated platform

Claoué



160mm

CP401

5x6 teeth



170mm

CP936

1x2 teeth and
serrated platform

Debaquey



1,5mm
7831A-18
serrated jaws



1,5mm
CP988-18
serrated jaws



1mm
CP409
1x2 teeth



1,5mm
7833A-18
1x2 teeth

Potts-Smith



3mm
3740090
1x2 teeth

Barraya



1,5mm
CP933-18
3x4 teeth and serrated platform



6x6 teeth
CP400-2

Debaquey



200mm	210mm
7832	7834
1mm serrated jaws	1mm 1x2 teeth



2mm
7831A-20
serrated jaws



1,5mm
CP988-20
serrated jaws



2mm
7833A-20
1x2 teeth



Magnan

Adson



110mm		120mm		160mm		200mm	
CP392-1R	CP604BR	CP605BR	CP392-2R	CP392-8R	CP392BI	CP392BS	
smooth jaws 1x8mm	serrated jaws 1.5mm	1x2 teeth 1.5mm	smooth jaws 1x8mm	smooth jaws 1x8mm	smooth jaws 0.5x5mm	smooth jaws 0.5x5mm	



Adson



110mm

CP390-1

Smooth jaws
1x8mm



120mm

CP604M

Serrated jaws
1.5mm



CP605M

1x2 teeth
1.5mm



160mm

CP390-2

Smooth jaws
1x8mm



CP390-8

1x2 teeth
1x8mm

Halsey

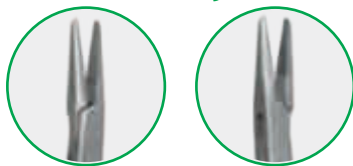

130mm

703T

serrated jaws

704T

Smooth jaws

for needle 4/0 5/0



703T

Ryder

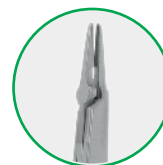

130mm

3744027

Jaws 1mm



Crile-Wood Mayo-Hégar

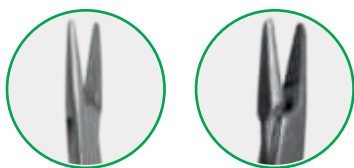

150mm

702T

needle 4/0 5/0 6/0

714T

1/0 2/0 3/0 4/0



702T

Becker



130mm

CP1107

Diamond jaws

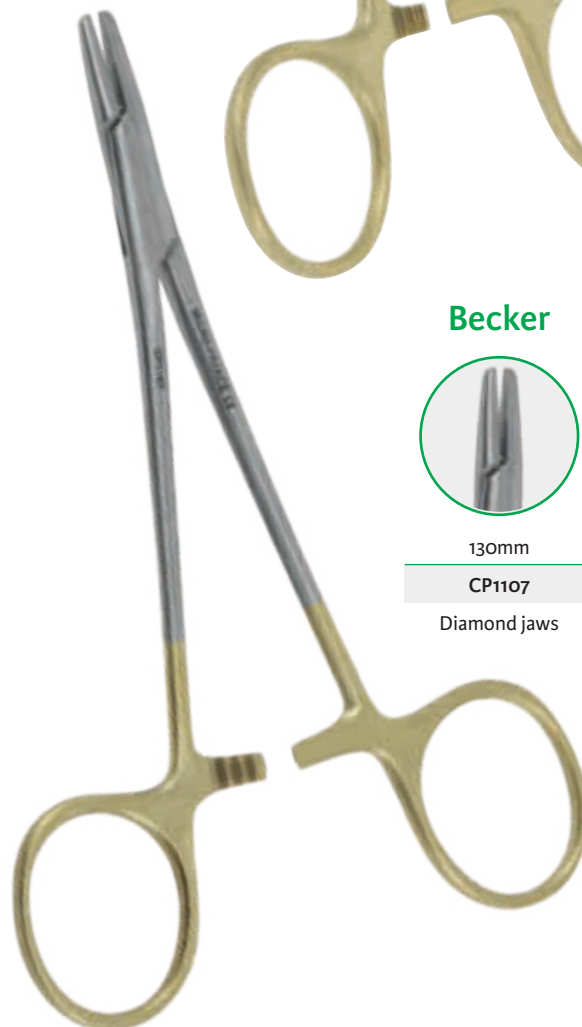

Hartmann-Mosquito

95mm - without teeth

3755111	3755110
Curved	Straight

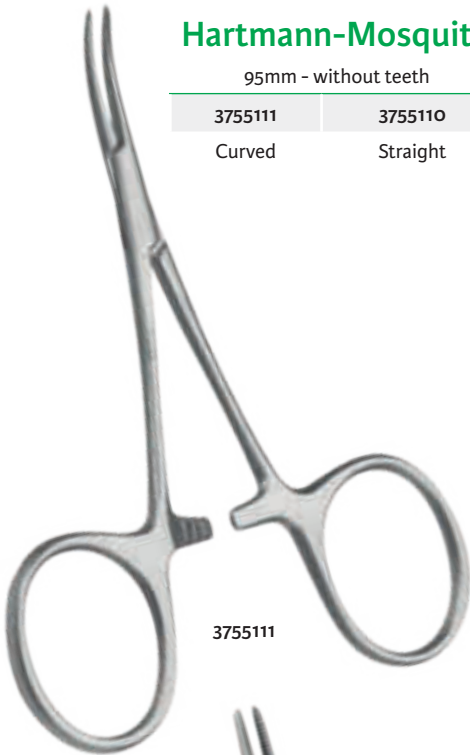

Halsted-Mosquito

120mm - without teeth

3755102	3755101
Curved	Straight



Mosquito

120mm - without teeth

3755107	3755106
Curved	Straight

extra delicate jaws

Leriche

140mm - without teeth

7867-1	7867-2
Straight	Curved

140mm - with teeth

7867-3	7867-4
Straight	Curved



Halsted

120mm - with teeth

P761-7	P761-8
Straight	Curved



Crile

140mm - without teeth

3755116	3755117
Straight	Curved



3755117

Kelly

without teeth

140mm	160mm
3755114	P762-2
Straight	Curved
	P762-4
	Curved



P762-2

Rochester-Péan

170mm - without teeth

3755136
Curved

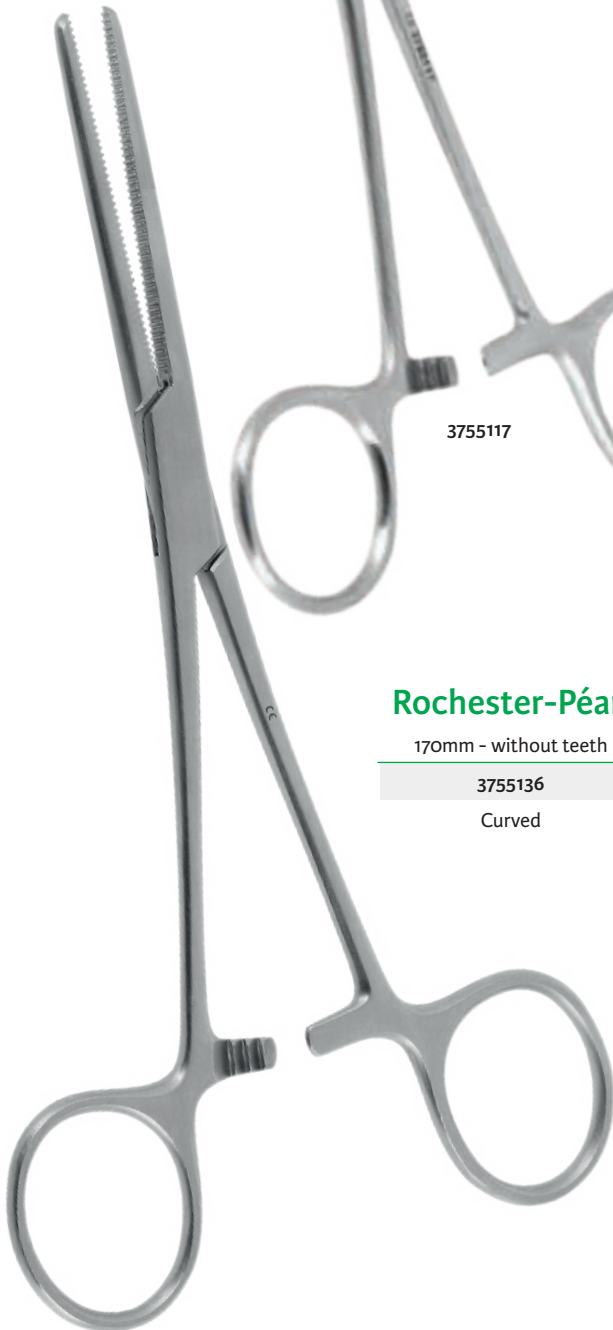

Kocher

140mm 160mm 180mm

Straight without teeth		
P764-1	P764-5	-
Straight with teeth		
P764-3	P764-7	P764-11



P764-3



130mm

3755010

Towel clamp
serrated jaws



Martel

130mm

P763

Forceps with
teeth, 'T' tip



Péan

140mm 160mm

P765-14 P765-16

Haemostatic forceps
serrated jaws



Terrier

130mm

P769

Haemostatic forceps
serrated jaws

P765-14

Backauss

90mm 120mm

3755000	3755001
---------	---------

Towel clamp



3755000

Allis

Forceps with teeth

140mm 150mm

3755160	3755161
---------	---------

3x4 teeth 4x5 teeth



3755161

Chaput

130mm

7866-13

2x3 teeth

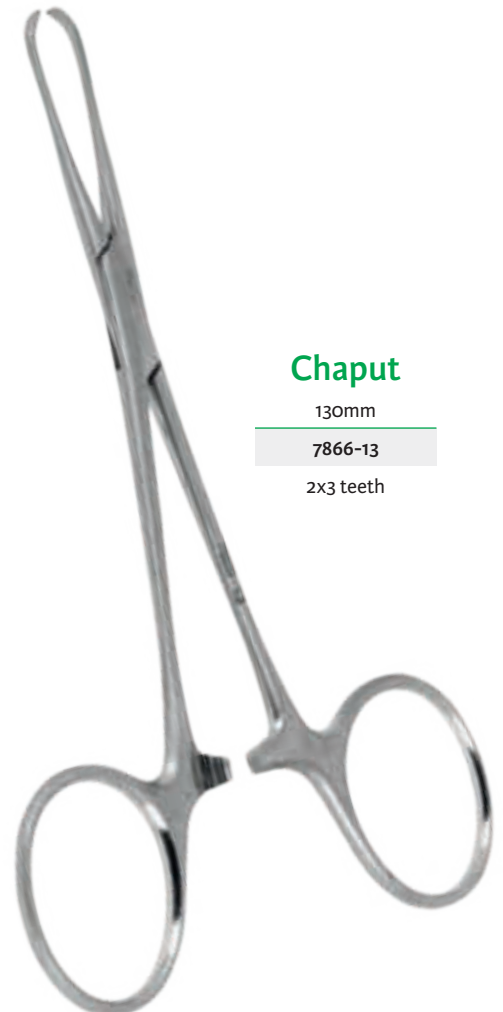

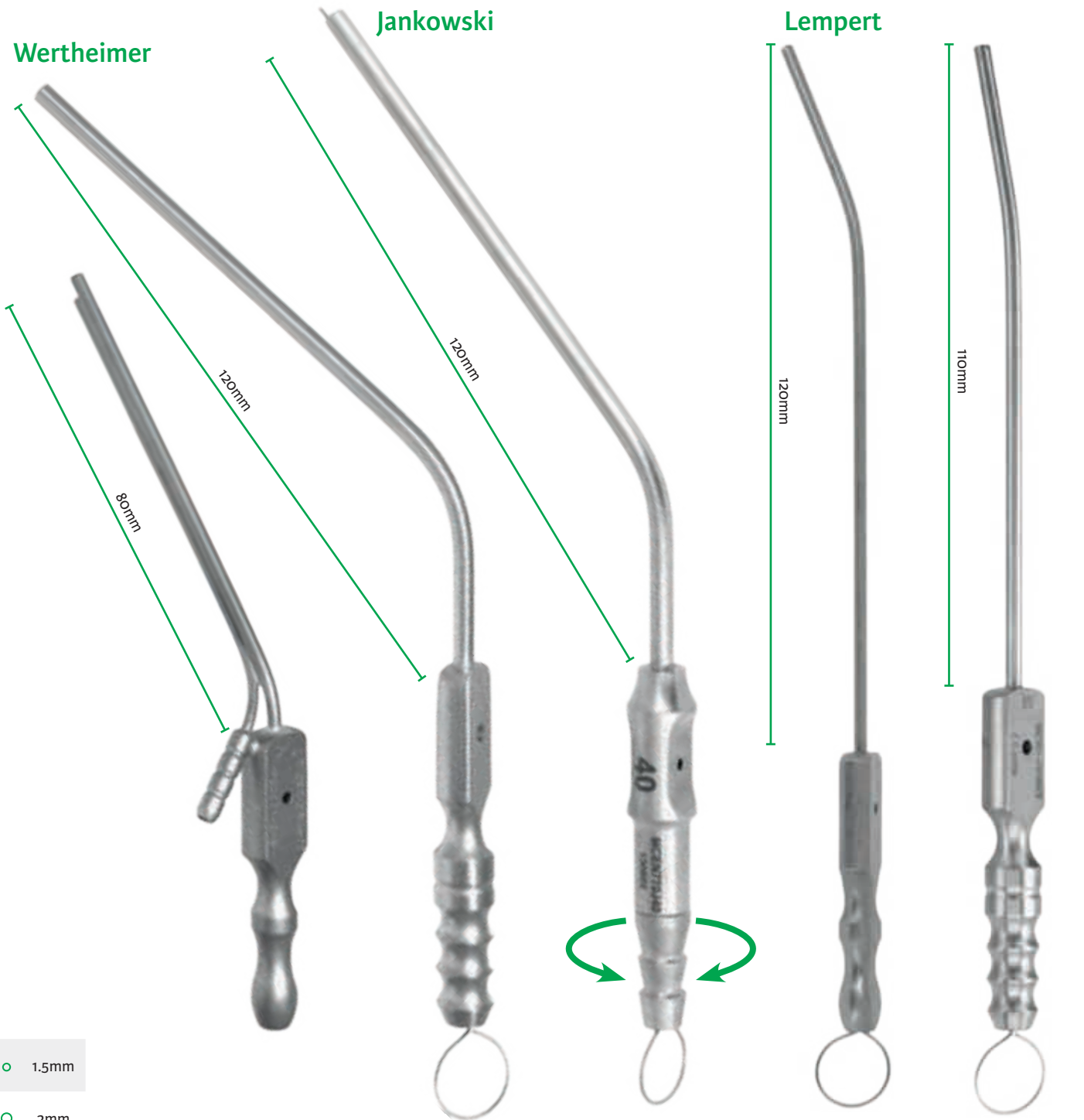

- 1.5mm
- 2mm
- 2.5mm
- 3mm
- 3.5mm
- 4mm

Wertheimer

MCO201-2-5	2.5mm
MCO201-3-0	3mm

Jankowski

MCO770-1-5	1.5mm
MCO770-2-0	2mm
MCO770-2-5	2.5mm
MCO770-3-0	3mm
MCO770-3-5	3.5mm
MCO770-4-0	4mm

Lempert

MCEN770J40	4mm
MCEN770J30	3mm

Lempert

MCO771-2-5	2.5mm
MCO771-3-0	3mm
MCO771-4-0	4mm

Lempert

CP330-3-0	3mm
CP330-4-0	4mm

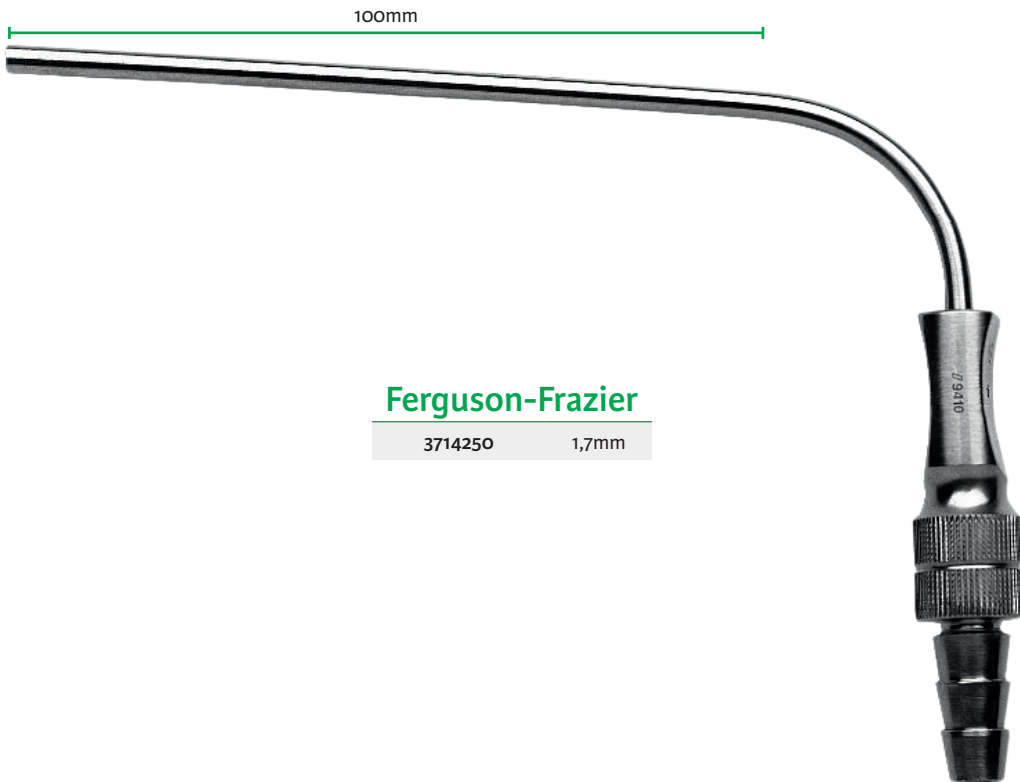

Ferguson-Frazier

3714250	1,7mm
---------	-------

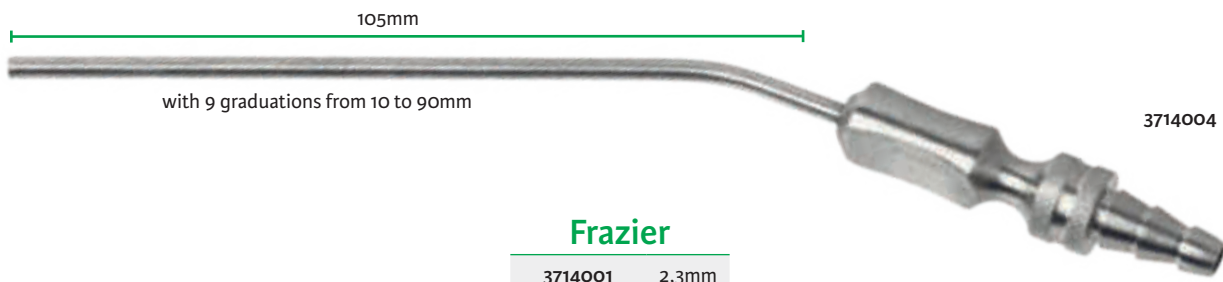

with 9 graduations from 10 to 90mm

3714004

Frazier

3714001	2,3mm
3714002	2,7mm
3714003	3mm
3714004	3,3mm
3714006	4mm

delivered with mandrel

Luer-lock adapter

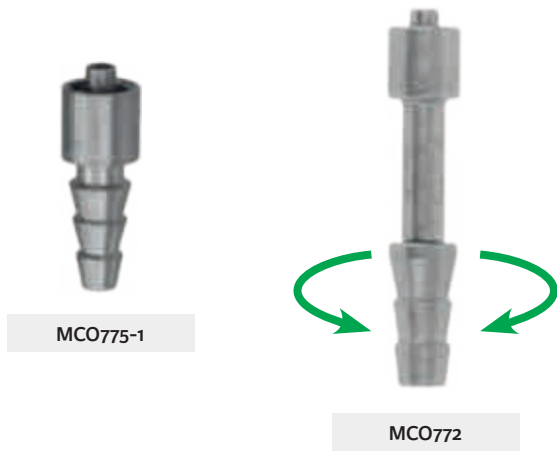

Suction tube adapter with finger control

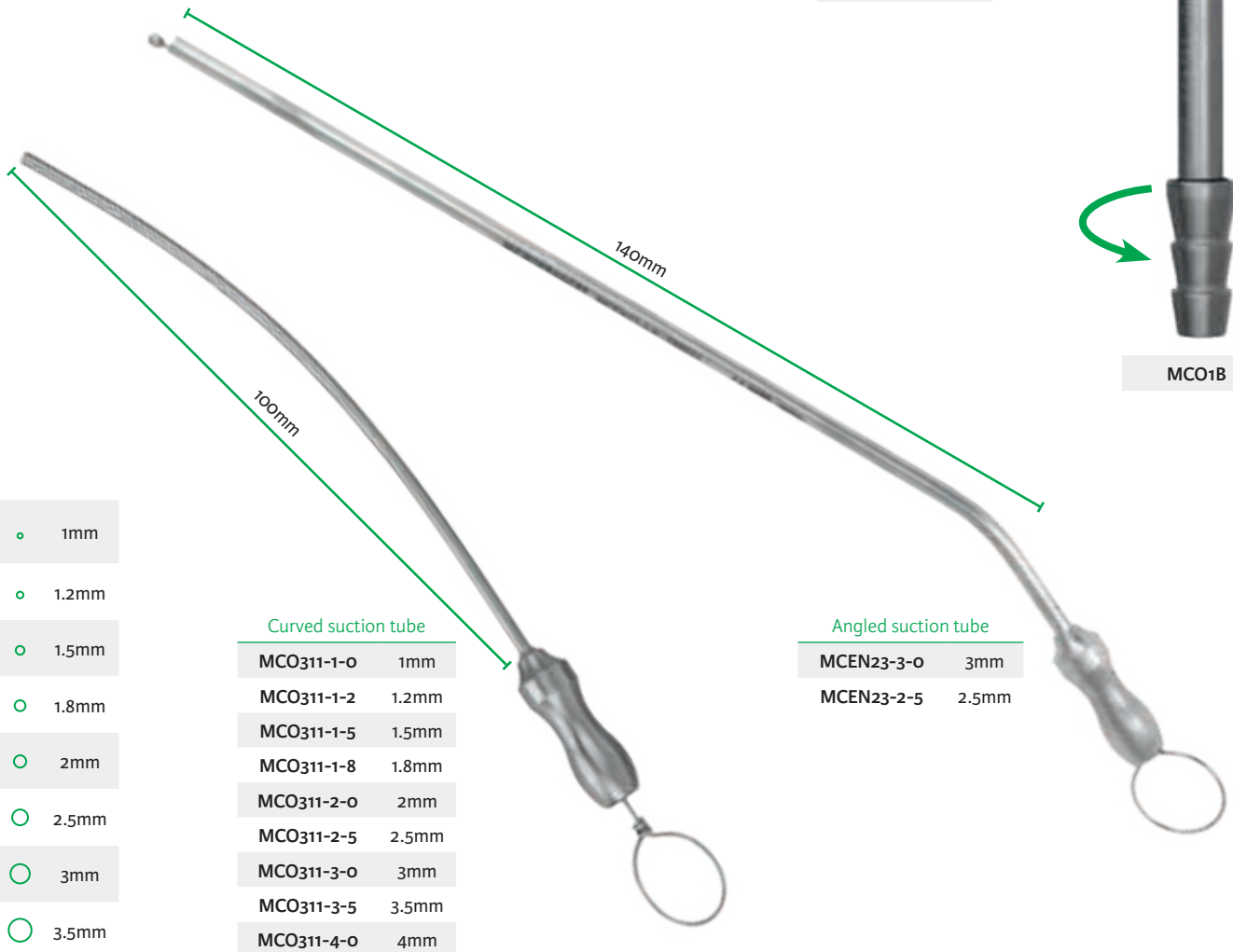

- 1mm
- 1.2mm
- 1.5mm
- 1.8mm
- 2mm
- 2.5mm
- 3mm
- 3.5mm
- 4mm

Curved suction tube

MCO311-1-0	1mm
MCO311-1-2	1.2mm
MCO311-1-5	1.5mm
MCO311-1-8	1.8mm
MCO311-2-0	2mm
MCO311-2-5	2.5mm
MCO311-3-0	3mm
MCO311-3-5	3.5mm
MCO311-4-0	4mm

Angled suction tube

MCEN23-3-0	3mm
MCEN23-2-5	2.5mm

110mm

MCEN37-1-20	2mm
MCEN37-1-25	2.5mm
MCEN37-1-30	3mm
MCEN371D35	3.5mm
MCEN371D4	4mm

Malleable

MCEN37-2-0	2mm
MCEN37-2-5	2.5mm
MCEN37-3-0	3mm
MCEN37-3-5	3.5mm
MCEN37D4	4mm



De Gabory

Handle for suction tube
rotatable connection

MCEN103LDG

Scale 2/3

MCEN103LDG

On - Off

120mm

Blunt suction tube
with finger control

MCEN770B25	2.5mm
MCEN770B30	3mm

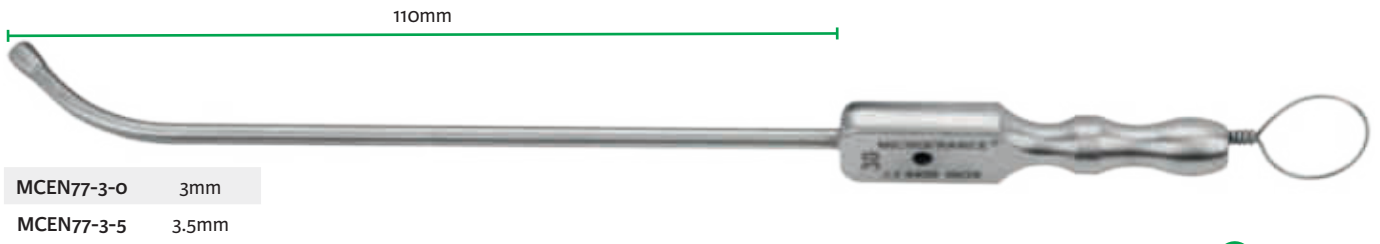

Jankowski

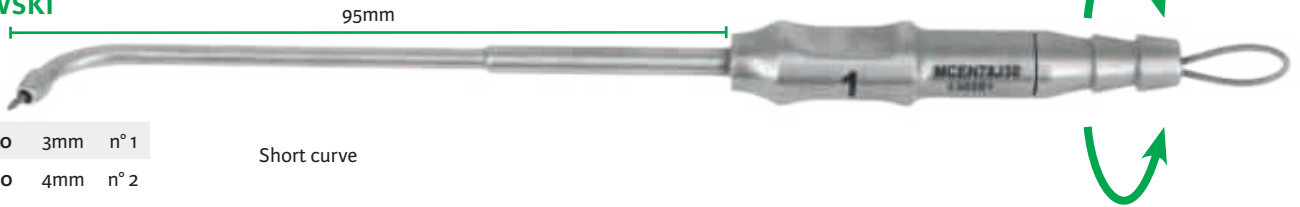

Jankowski



Orsel

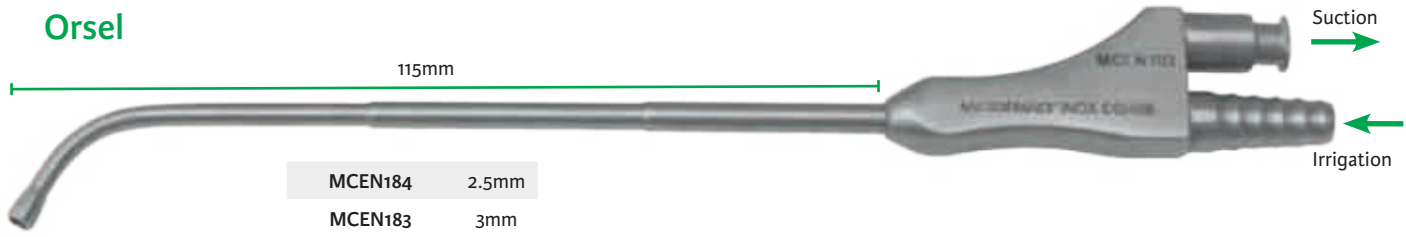

Orsel

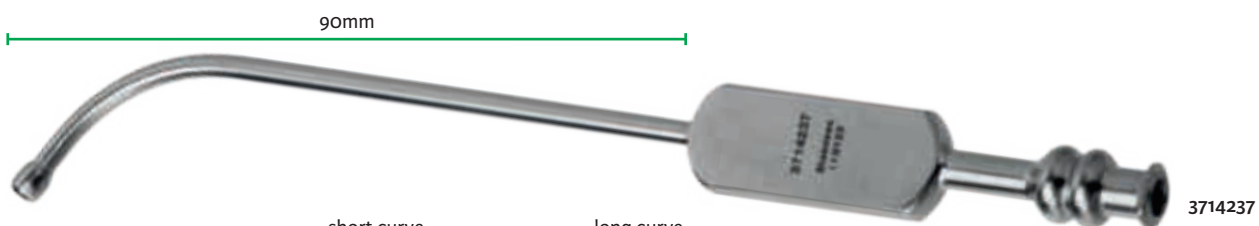
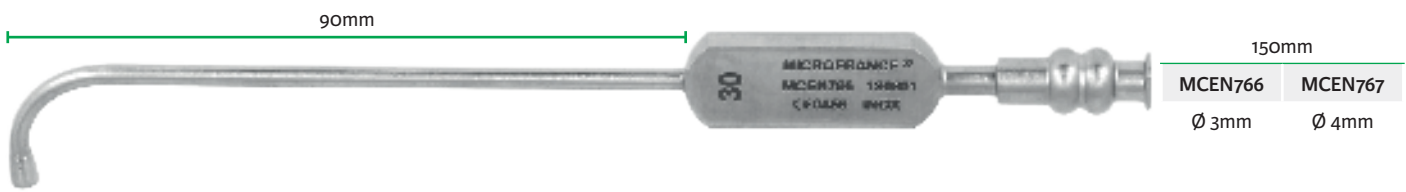

short curve		long curve	
3714238	3mm	3714237	3mm
3714239	4mm	3714240	4mm

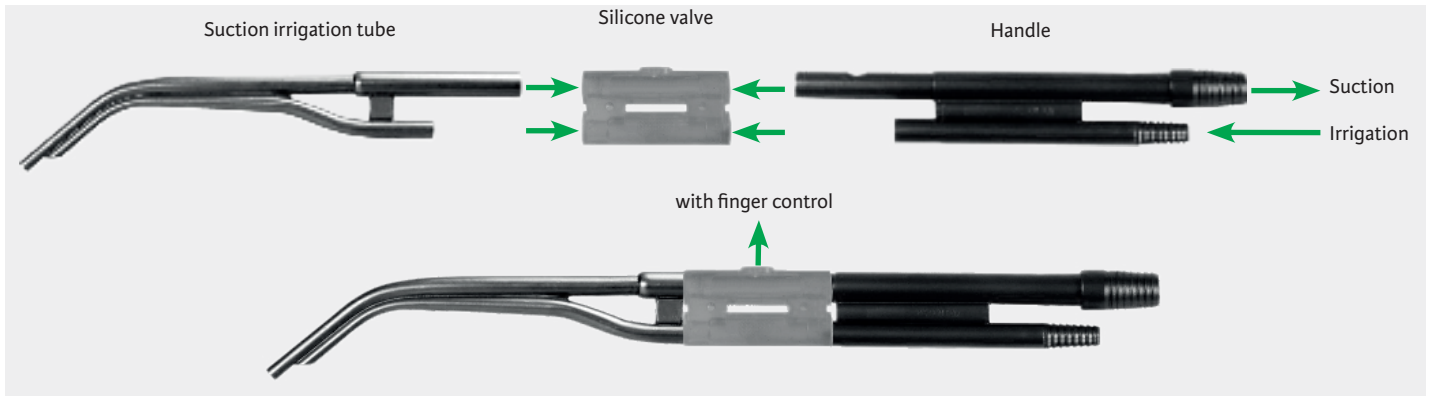

Handle
Delivered with silicone valve

1375012



Suction irrigation tube without hole

Reference	Working length	Size fr	Size mm
1375020	100mm	10X10	3.3 X 3.3



Suction irrigation tube with hole

Reference	Working length	Size fr	Size mm
1375025	100mm	10X10	3.3 X 3.3



1375025

1375101 90mm 5X4 1.7 X 1.4

1375102 90mm 4X4 1.4 X 1.4

1375103 90mm 4X3 1.4 X 1

1375107 90mm 7X7 2.3 X 2.3

1375110 90mm 10X7 3.3 X 2.3

1375114 90mm 14X7 4.7 X 2.3

1375201 120mm 5X4 1.7 X 1.4

1375207 120mm 7X7 2.3 X 2.3

1375210 120mm 10X7 3.3 X 2.3

1375214 120mm 14X14 4.7 X 4.7



1375101



1375107



Scale 2/3

- 0° MCEN83-C
- 30° MCEN81-C
- 45° MCEN87C
- 70° MCEN82-C

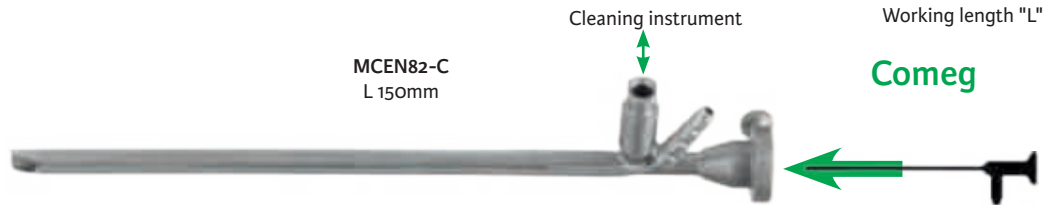

	L 140mm	L 125mm			
0°	MCEN83O	MCEN83OL	for scope (WA96200A)	-	-
30°	MCEN81O	MCEN81O1	(WA96201A)	MCEN81O2	for scope (WA96202A)
45°	-	MCEN87O3	(WA96203A)	MCEN87O4	(WA96204A)
70°	MCEN82O	MCEN82O5	(WA96205A)	MCEN82O6	(WA96206A)

- 0° MCEN83-S
- 30° MCEN81-S
- 45° MCEN87-S
- 70° MCEN82-S



- 0° MCEN83-W
- 25° MCEN81-W
- 30° MCEN81-W
- 45° MCEN87W
- 70° MCEN82-W

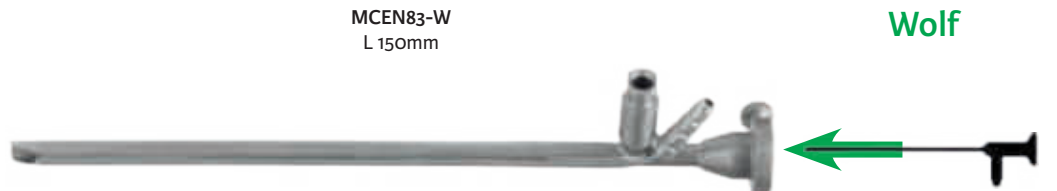

Sleeve for variable scope

MCEN88SC

for scope : pattern :
Olympus WA9T400V
Sopro Comeg Ulyss



^(D) Distributed by Integra MicroFrance SAS (France) - For corresponding manufacturer part numbers, see table in annex

Scale 2/3

Trocar and cannula

Working length "L"

Rouvier

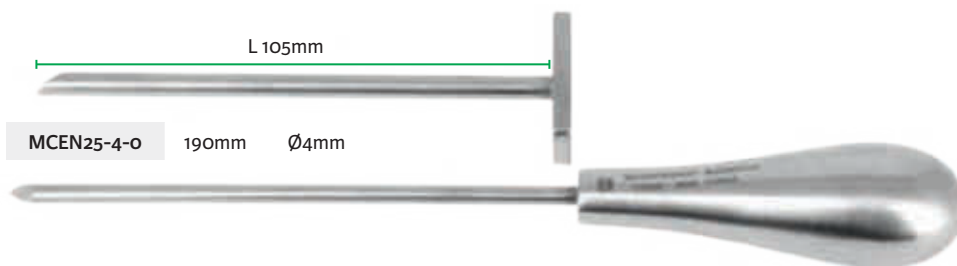

Biopsy cup forceps
for trocar MCEN25-4-0

MCEN28

Double-action jaws
2x5mm

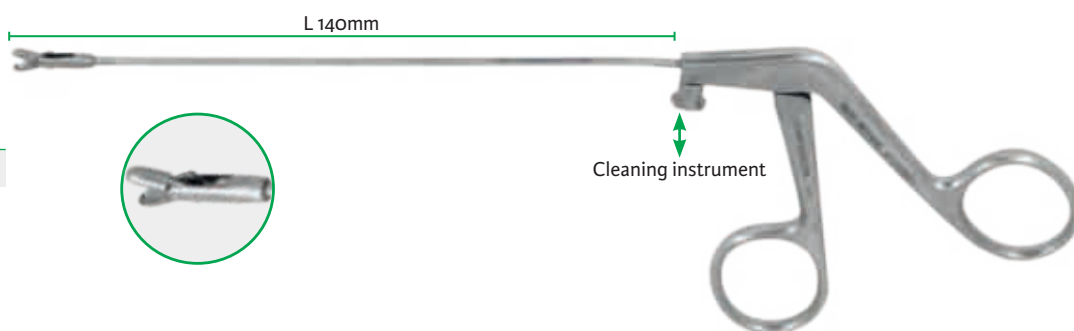

Albertini

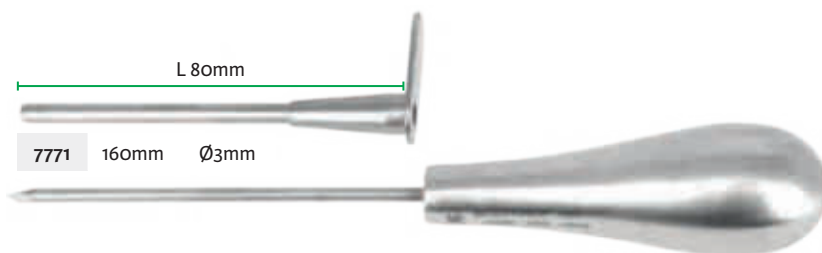

Irrigation tube

Albertini

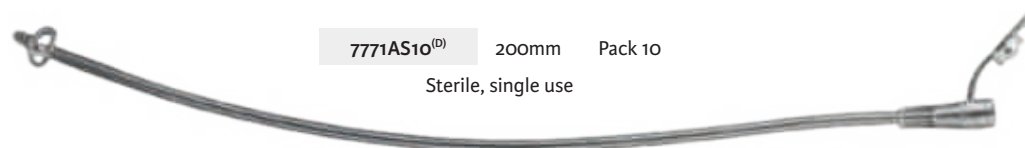

Irrigation tube guide

Albertini



⁽¹⁾ Distributed by Integra MicroFrance SAS (France) - For corresponding manufacturer part numbers, see table in annex

Pradès

220mm

MCEN55

7,5mm



Gillies

230mm

3714379

7mm

Seeker

Pick



200mm

3714231

ball
Ø 1,2mm



190mm

MCEN713

ball
Ø 2,3mm



190mm

3714232

ball
Ø 2,3 - 2,6mm



160mm

1352431

Ø 0,6mm
"Mushroom" pick

Herman



235mm
MCEN127
Knife
4x5mm

Friedrich



190mm - Sickle knife
3714282 Sharp tip

Rouvier



180mm
MCEN50
Dissector
and knife

Lérault



190mm
MCEN103
Angled
elevator
3mm

Dacryocystorhinostomy



3718010



3718020



150mm
3718010 sickle knife
3718020 diamond knife

Scale 2/3

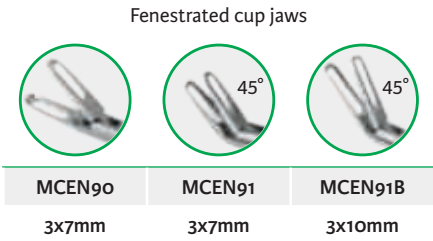
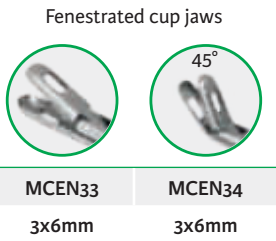
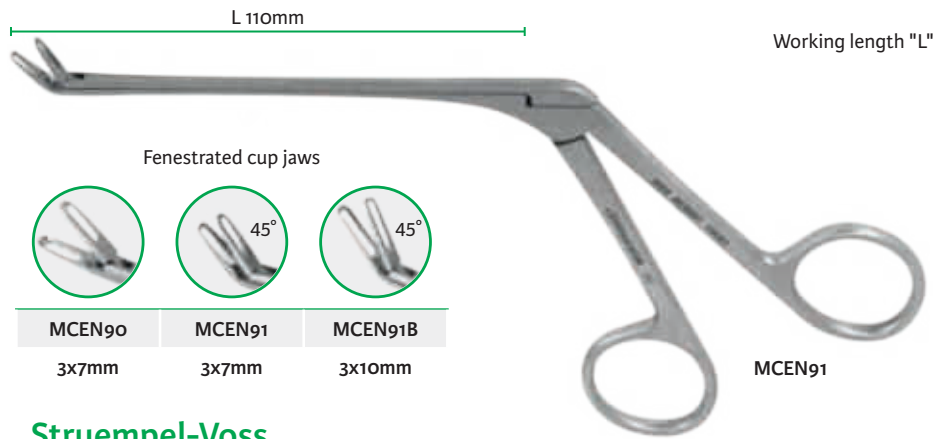

Blakesley-Klossek

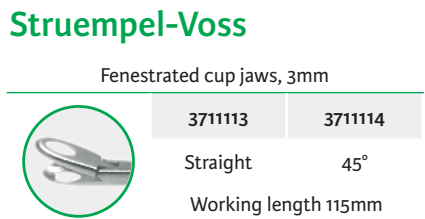
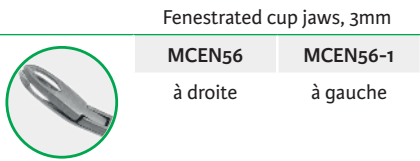

Klossek

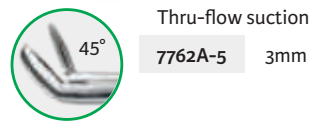
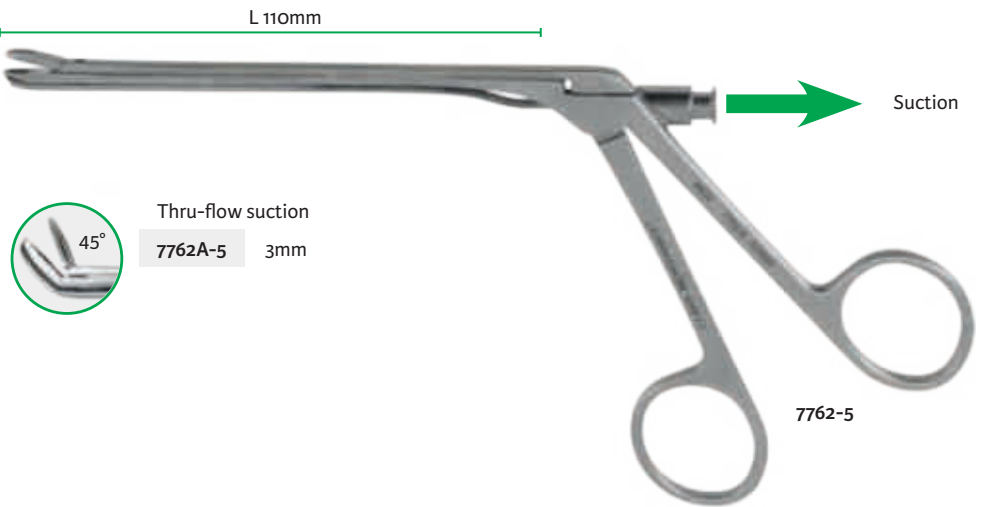
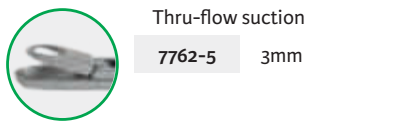

Dessi

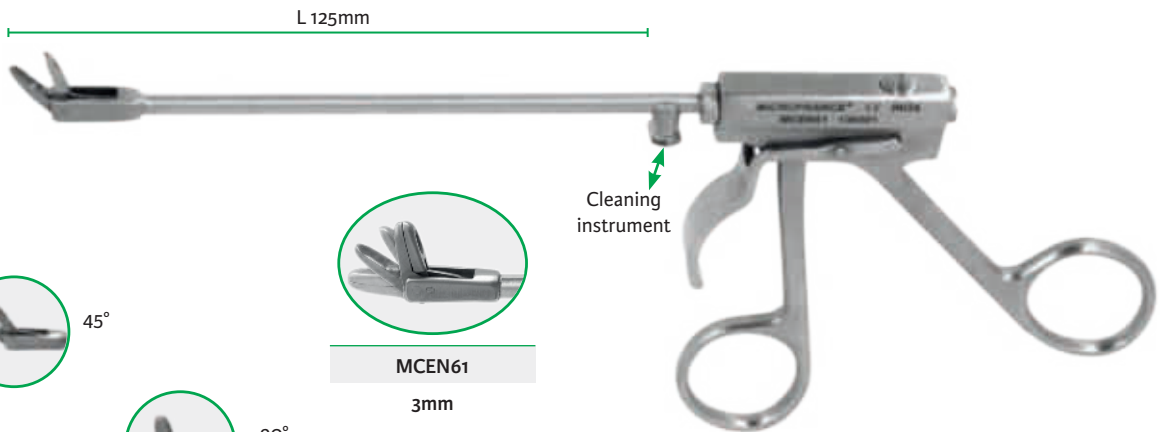
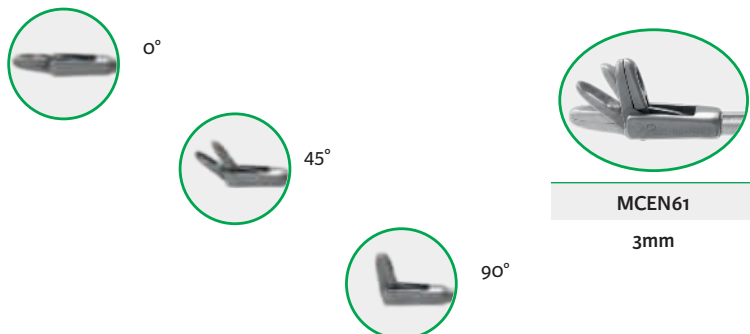

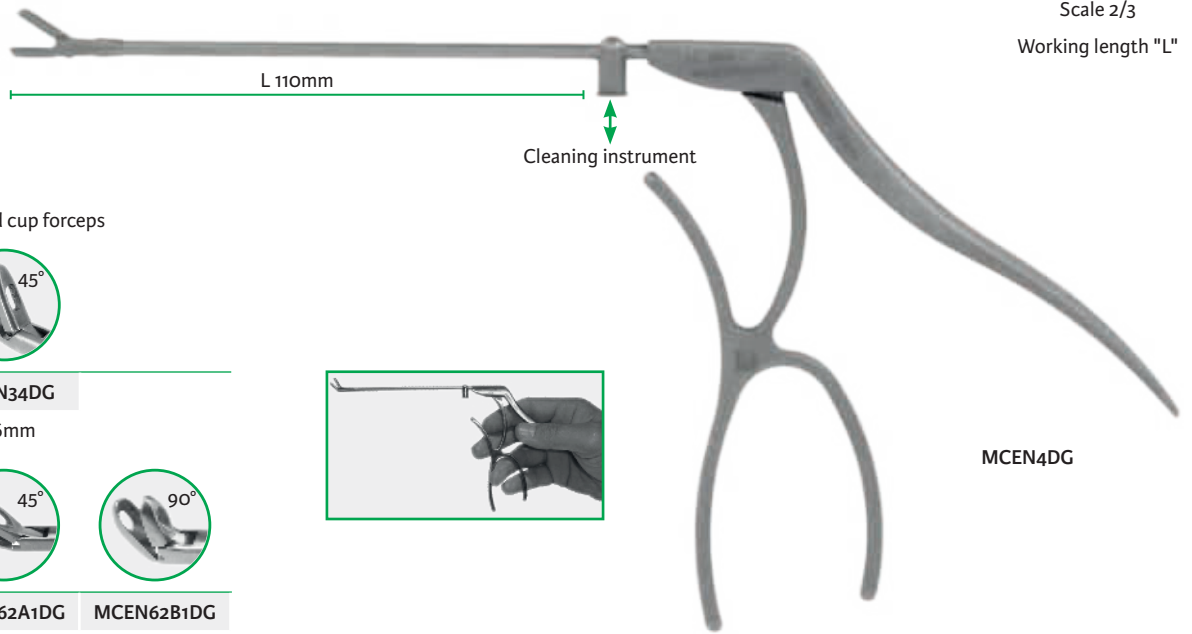

Fenestrated cup forceps



MCEN33DG 3x6mm
MCEN34DG 3x6mm



MCEN62T1DG 3x8mm
MCEN62A1DG 3x8mm
MCEN62B1DG 3x8mm



MCEN62T2DG 5x11mm
MCEN62A2DG 5x11mm
MCEN62B2DG 5x11mm

Fenestrated cup forceps



MCEN90DG 3x7mm
MCEN91DG 3x7mm
MCEN91BDG 3x10mm

Cup forceps



MCEN4DG 3x6mm
MCEN5DG 3x6mm
MCEN5BDG 3x12mm

Stylet handle for curette insert

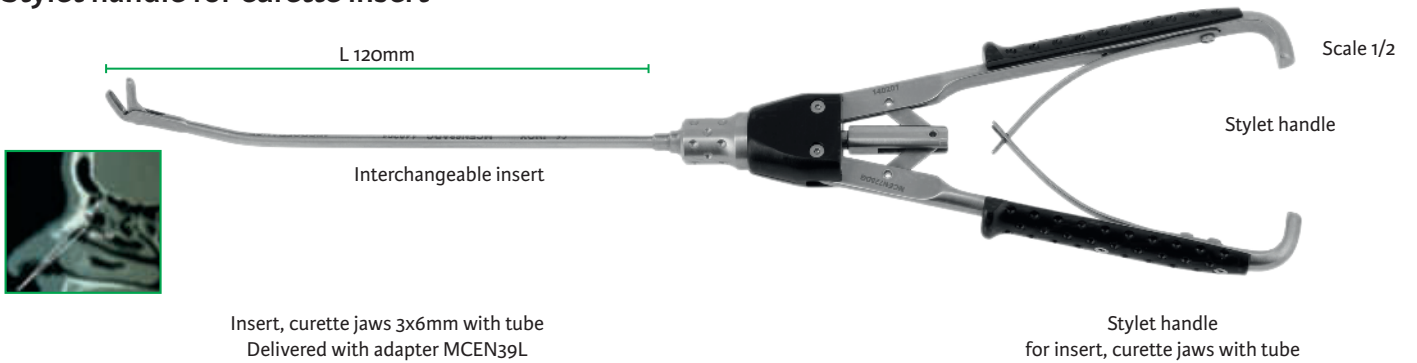

MCEN68CDG
Straight tube



MCEN68BDG
Angled tube

MCEN68ADG
Insert 45°
angled tube

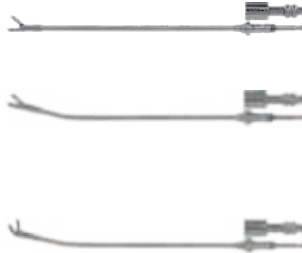

Scale 1/4

MCEN728DG



MCEN39L

Scale 1/2

Adapter luer-lock for tube insert cleaning port - Pack 3

Scale 2/3

Working length "L"

Fenestrated cup forceps

Straight 45° 90°



jaws 3x8mm

MCEN62T1 MCEN62A1 MCEN62B1



jaws 5x11mm

MCEN62T2 MCEN62A2 MCEN62B2



jaws 6x11mm

MCEN62T3 MCEN62A3 MCEN62B3



90°

jaws 4x17mm

7762A4



MCEN62A2

Cup forceps, curved up



Curve	Horizontal opening	Vertical opening
70°	MCEN350H	MCEN350V
100°	MCEN360H	MCEN360V

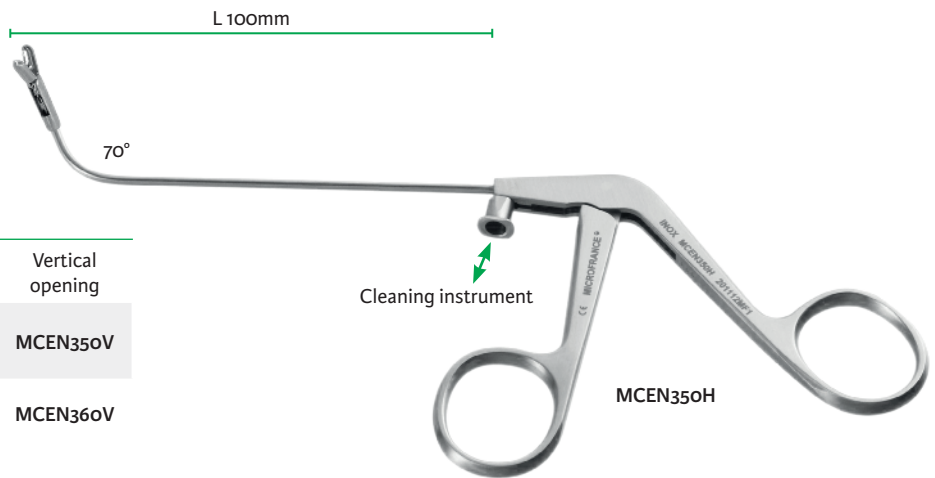

MCEN350H

Cleaning instrument

Cup forceps, curved up, pear jaws



MCEN960H

curve 80°

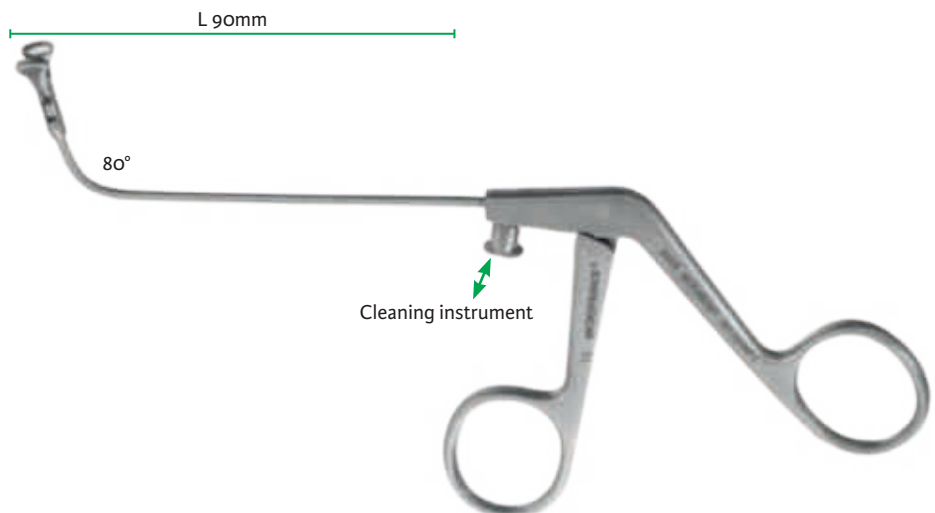

Cleaning instrument

Rouvier



MCEN4
3x6mm



MCEN5
3x6mm



MCEN5B
3x12mm



MCEN43
1x4mm
30°



MCEN3
2mm

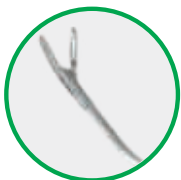

MCEN29
2x5mm
45°
right vertical
opening

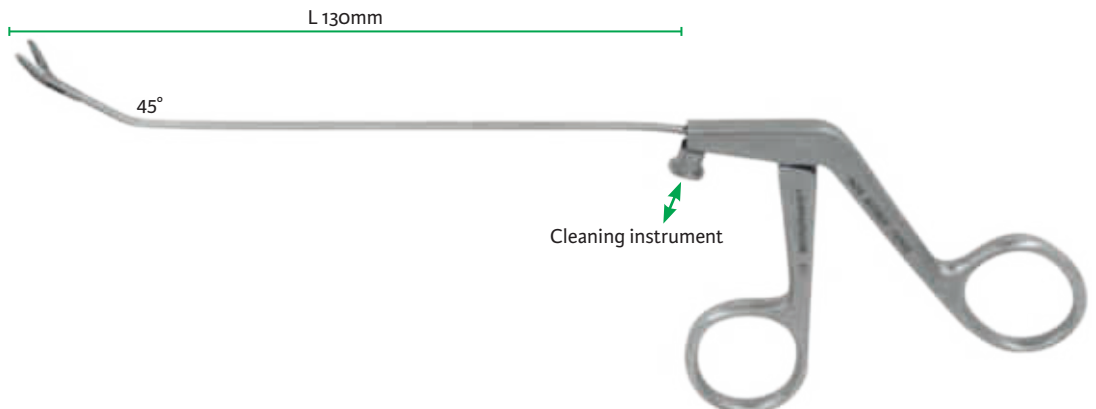
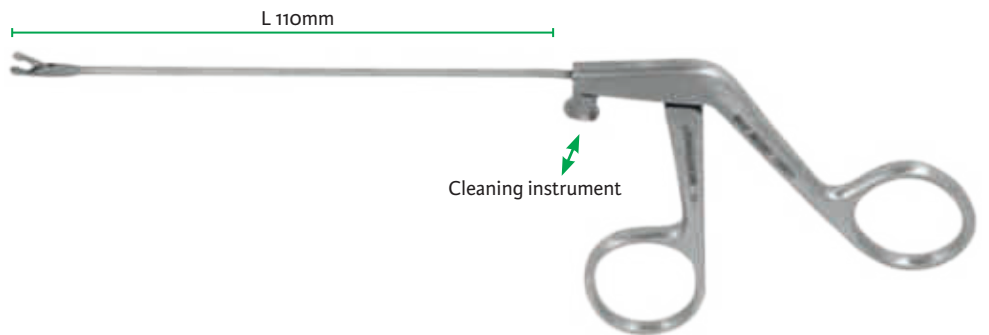
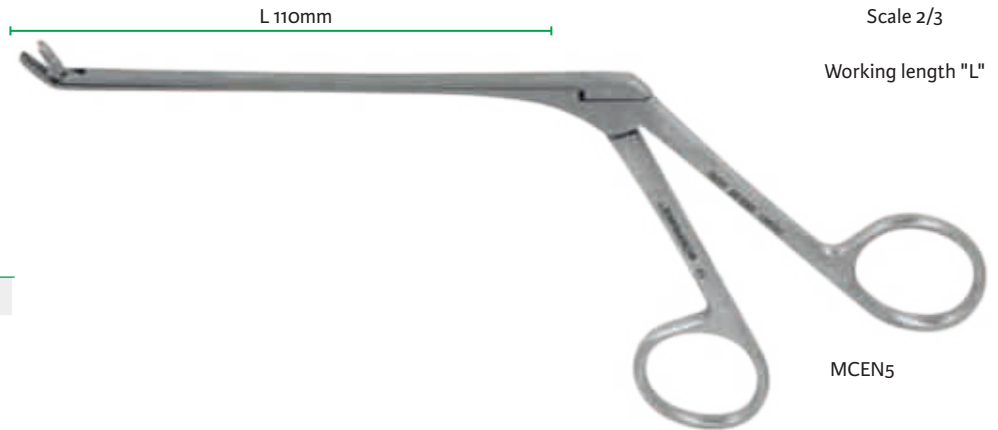

Takahashi

Scale 2/3

L 110mm

Working length "L"



3711020	3711021	3711109
2.5x8mm	4x9mm	2.5x12mm



3711020

L 160mm



3711017	3711018
2x10mm	3x10mm



3711017

L 110mm

Suction

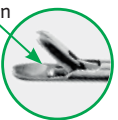

3711077	3711078
2.5x8.5mm	3.5x8.5mm

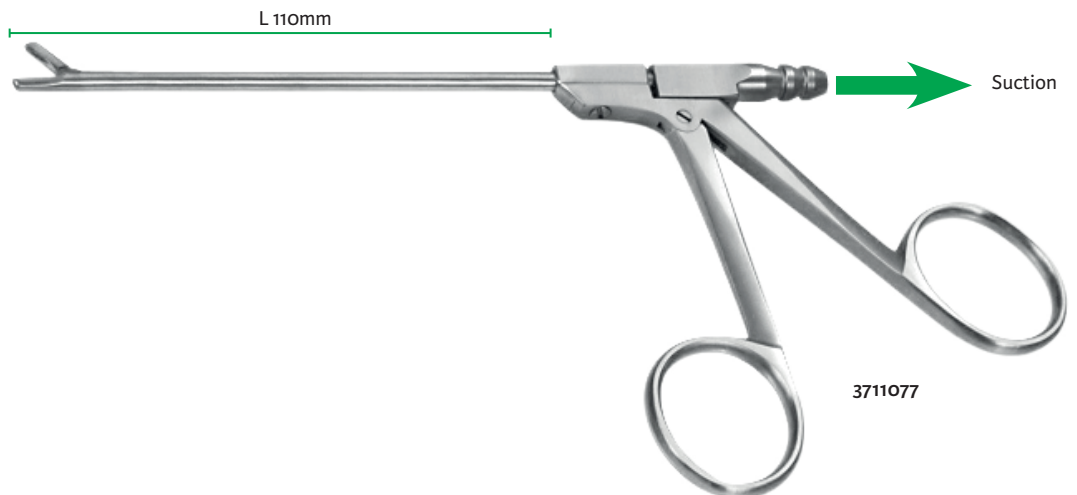

3711077

Fenestrated cup forceps

Weil-Blakesley

Blakesley

Straight

45°

90°



7762-1

7762A-1

7762B-1

Jaws 3mm

Weil-Blakesley



7762-2

7762A-2

3.5mm jaws

Weil-Blakesley

Straight

45°

90°



3711038

3711039

Jaws 3mm

3711043

3711040

3711047

Jaws 3.5mm

3711044

3711041

3711048

Jaws 4mm

3711045

-

-

Jaws 5mm

3711118

3711119

Jaws 6mm

Weil-Blakesley

Straight

30°



3711072

-

Jaws 2.5mm

3711073

3711076

Jaws 3.5mm

3711074

Jaws 4mm

L 110mm



Scale 2/3

Working length "L"

7762A-1

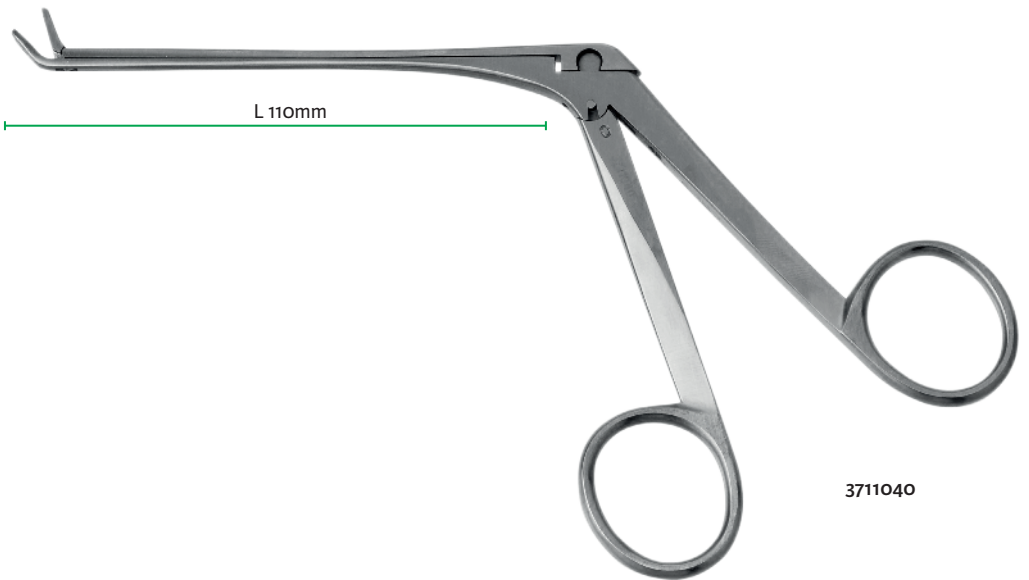

3711040



3711072

Scale 2/3

Working length "L"

Fenestrated cup forceps
Jaws 2mm

straight 45° 90°



7763

7763-1

7763-2

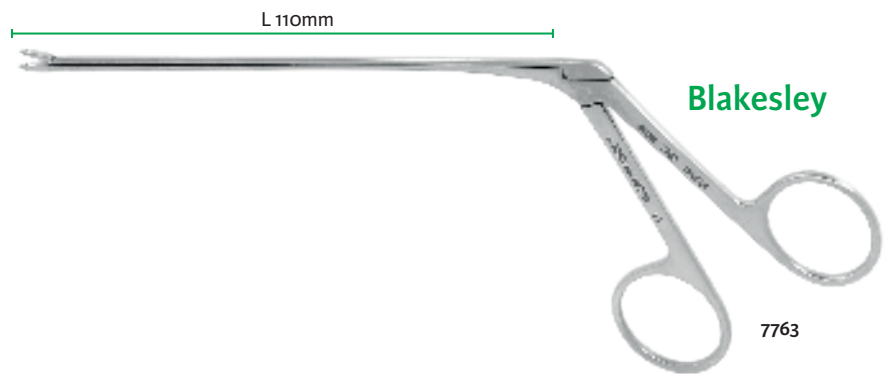

Fenestrated cup forceps
Jaws 2.4mm

straight 45° 90°

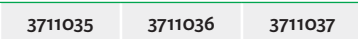

3711035

3711036

3711037

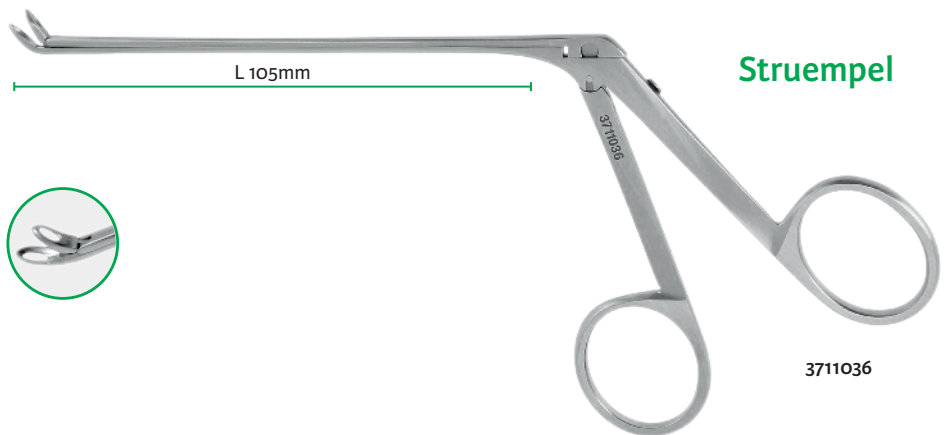

Fenestrated cup forceps
4mm jaws

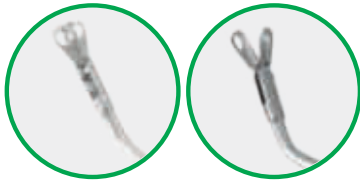

MCEN96

MCEN97

curved up 45°

right

left

L 95mm

Scale 2/3

Working length "L"

Cleaning instrument

MCEN96

Horizontal cup forceps
2x4mm jaws

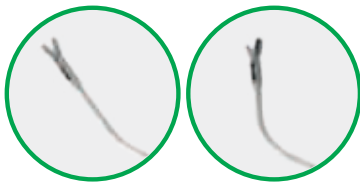

MCEN35

MCEN36

curved up 45°

Curved up 80°

L 120mm

Cleaning instrument

MCEN35

L 160mm

Peynègre-Bossard

Cleaning instrument

Fenestrated cup forceps
2x4mm jaws



MCEN53

curved 'S'

L 140mm

Peynègre

Cleaning instrument

Fenestrated cup forceps
3x4mm jaws



MCEN99

curved 'S'

Scale 2/3

Working length "L"

Orsel



3x4.5mm Jaws
MCEN68
Curved down 130°

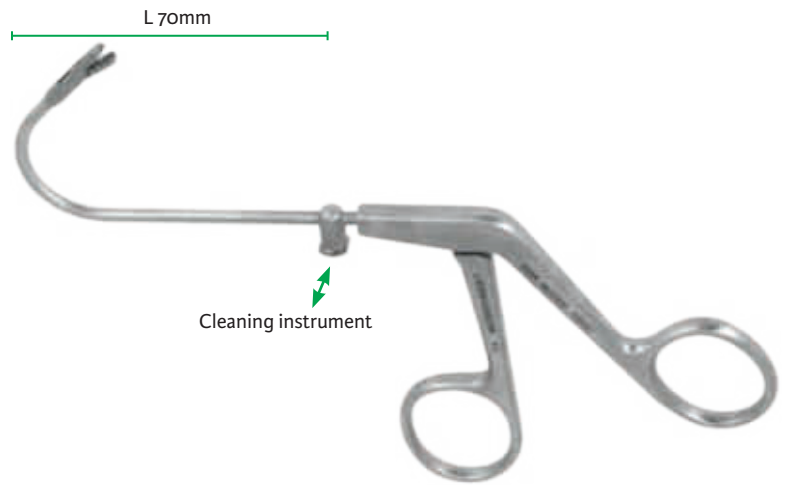

Heuwieser

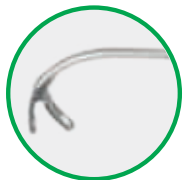

Antrum cup forceps
3711071
Curved down 90°



Skinner

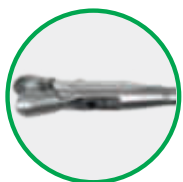

Maxillary biopsy cup forceps
3mm jaws

horizontal jaws	vertical jaws
3711128	3711127
Curved down 110°	Curved down 70°

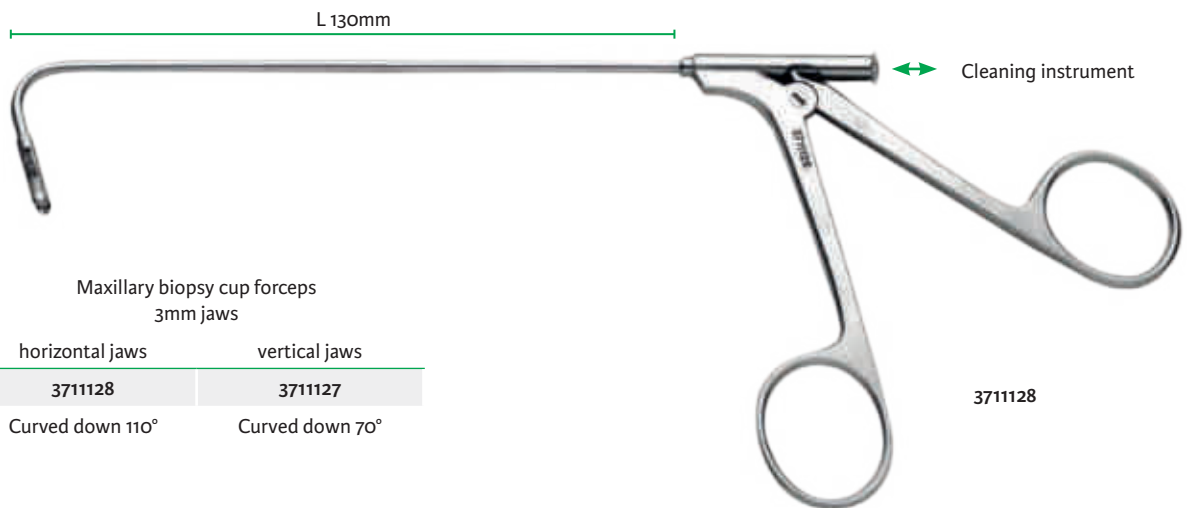

3711128

"Girafe"

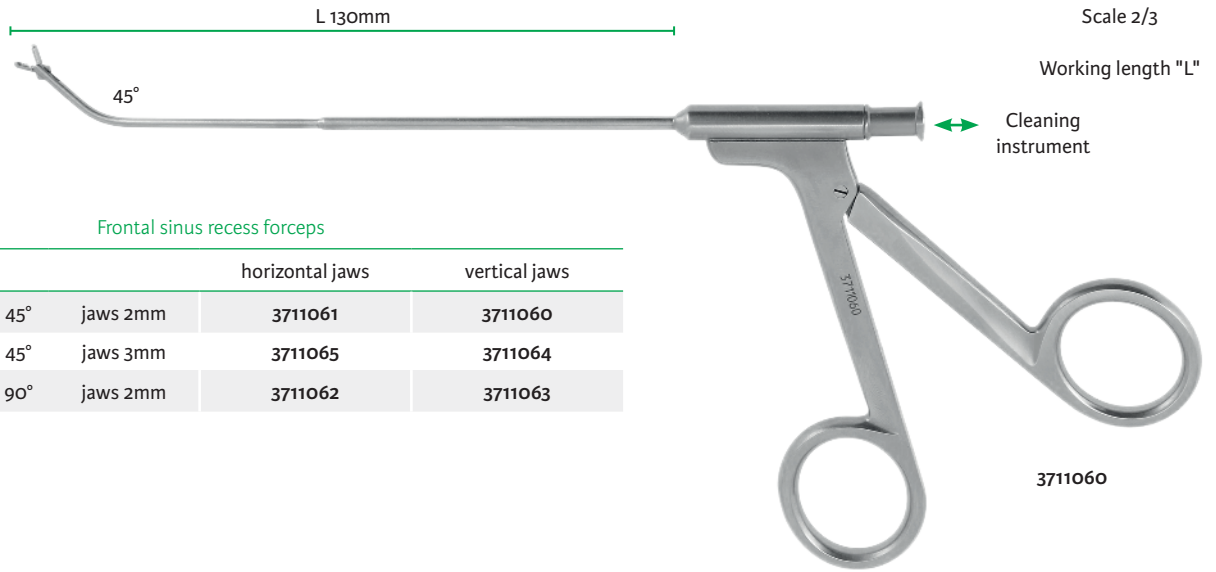

Frontal sinus recess forceps



		horizontal jaws	vertical jaws
45°	jaws 2mm	3711061	3711060
45°	jaws 3mm	3711065	3711064
90°	jaws 2mm	3711062	3711063

Biopsy and grasping forceps

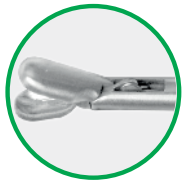

		horizontal jaws	vertical jaws
70°	jaws 3mm	3711049	3711053
70°	jaws 4mm	3711055	3711054
110°	jaws 3mm	3711050	
110°	jaws 4mm	3711056	

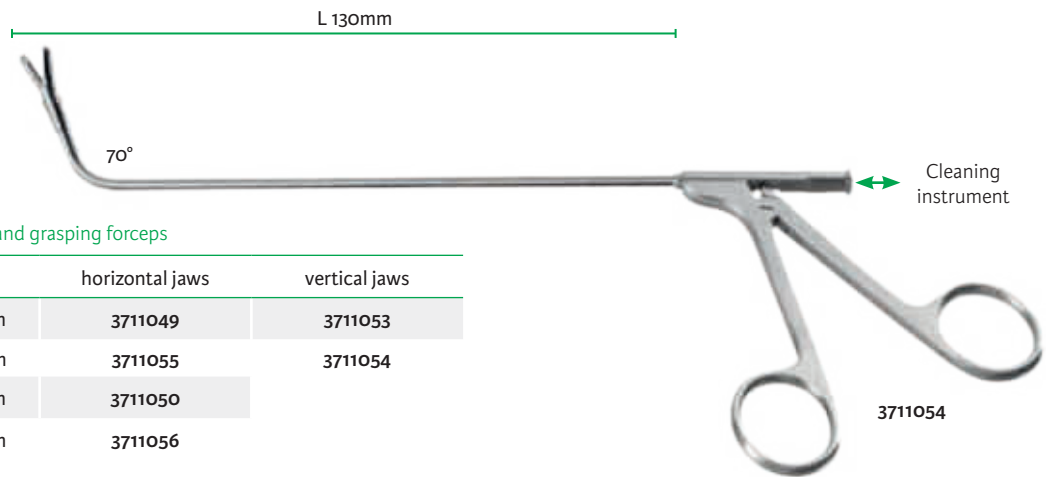

Pear-shaped cup jaws forceps



	Angled jaws 6mm
45°	3711068
80°	3711069



Scale 2/3

L 115mm

Working length "L"

Post biopsy cup forceps
Ø 3.5mm jaws

3711067



L 90mm

Cleaning instrument

Biopsy and grasping forceps double-action

3x6mm jaws

Straight 3711059

curved up

70° 3711129

110° 3711130



3711059

70°

L 130mm

Cleaning instrument

Punch biopsy forceps
curved up 70°

3711057

serrated jaws 2x6mm

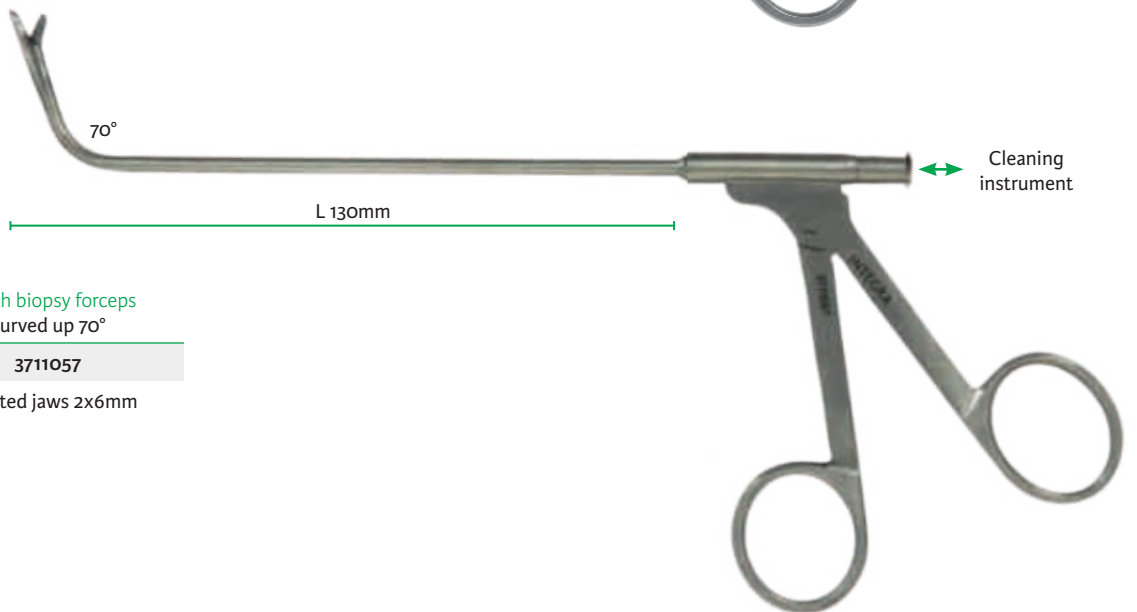

Terrier

curved down

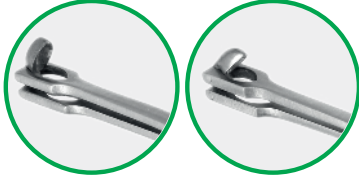

MCEN27-1 3x6mm jaws L 100mm	MCEN27 4x7mm jaws L 120mm
--	--



rotatable 360°
MCEN27R
2.5x7mm jaws

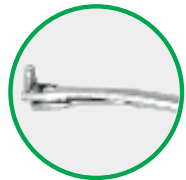
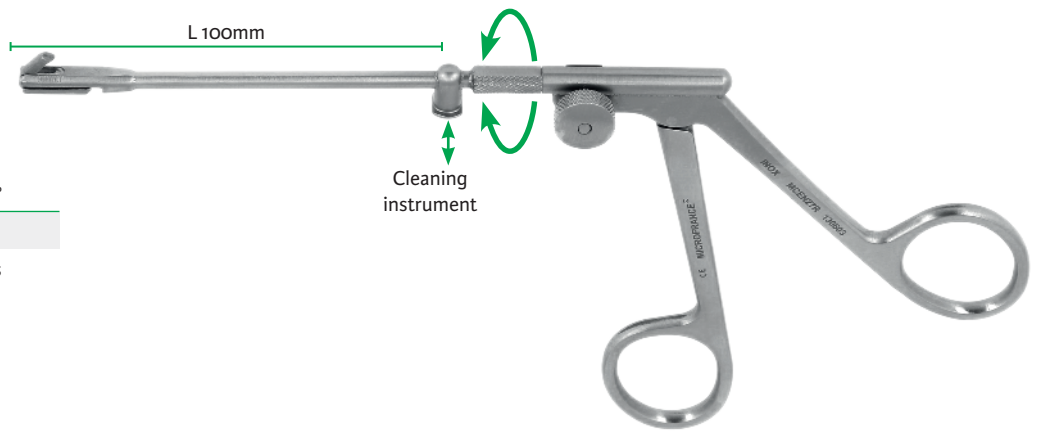

rotatable 360°
2x4mm jaws
3712012 **3712043**
curved down curved up

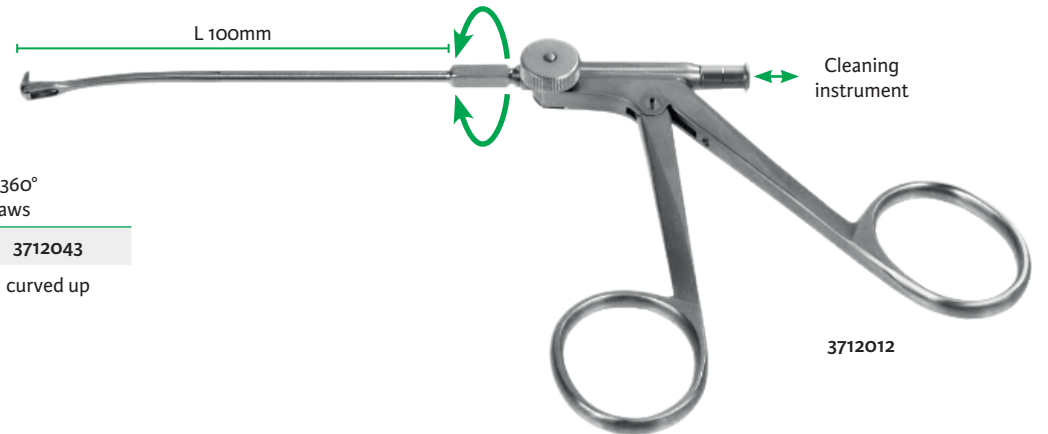

2.5x7mm jaws
3712032 up jaws
3712033 left jaws
3712034 right jaws

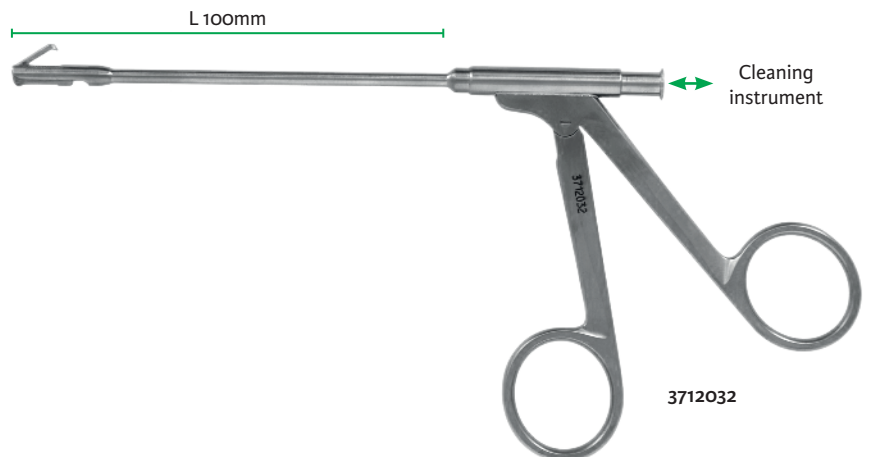

Terrier

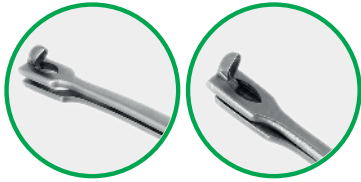

Jaws 2x4mm

MCEN27-2	MCEN27-3
curved down	curved up

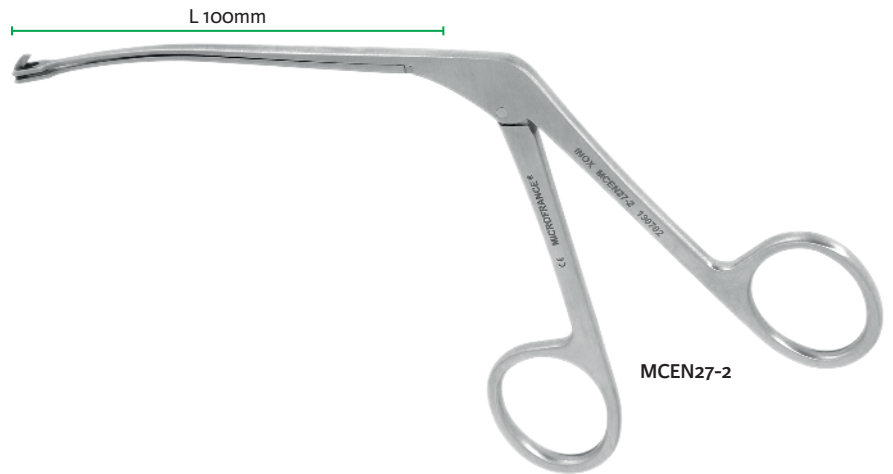

Jaws 2.5x7mm

3712037 right jaws

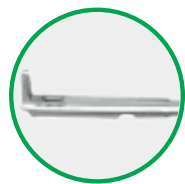
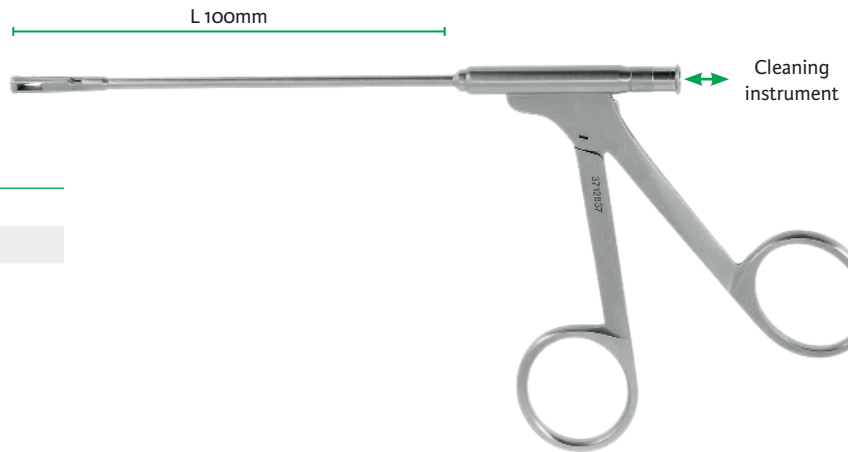

Rotatable 360°

3712013
Jaws 1.5x5mm

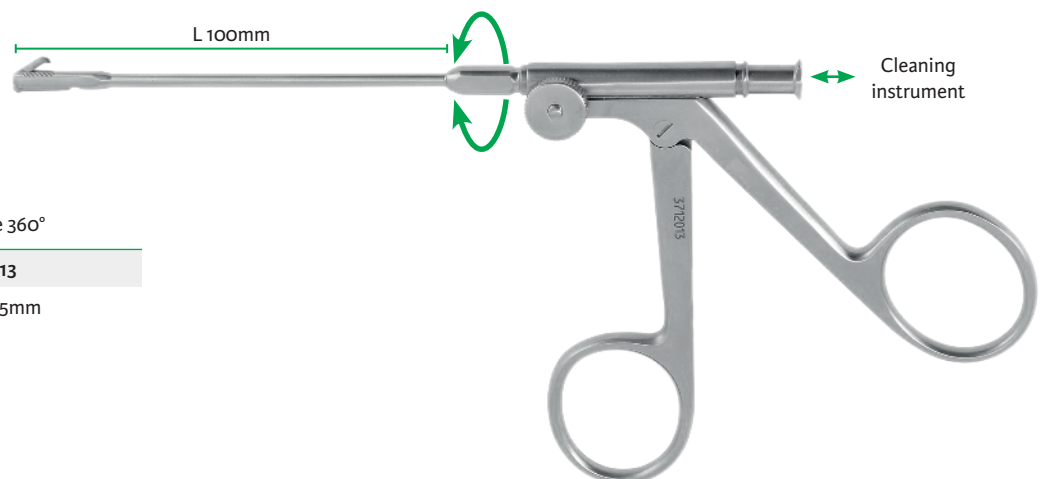

Terrier



Punch cutting forceps
"Joséphine"
MCEN38
left opening

Rouvier

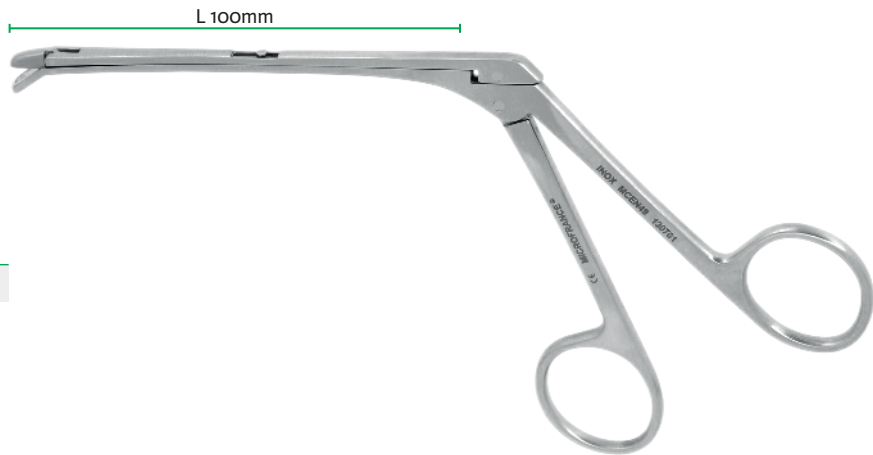

Backbiting punch
down 30°
MCEN49
jaws 4mm

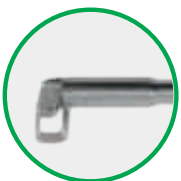
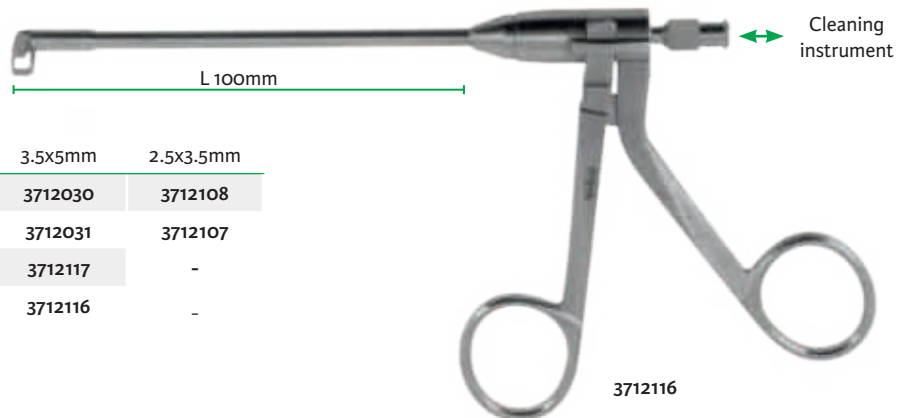
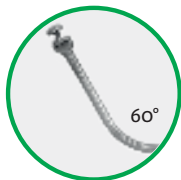
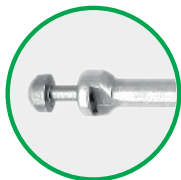
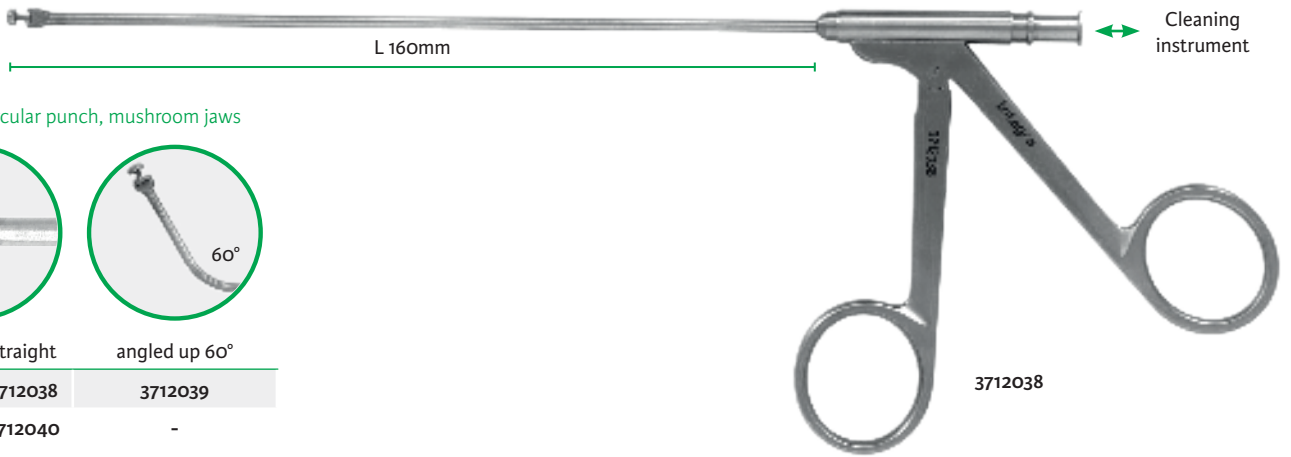

Scale 2/3

Working length "L"

Blakesley



3711079	2mm
3711080	2.5mm
3711140	2.5mm right
3711141	2.5mm left
3711081	3mm

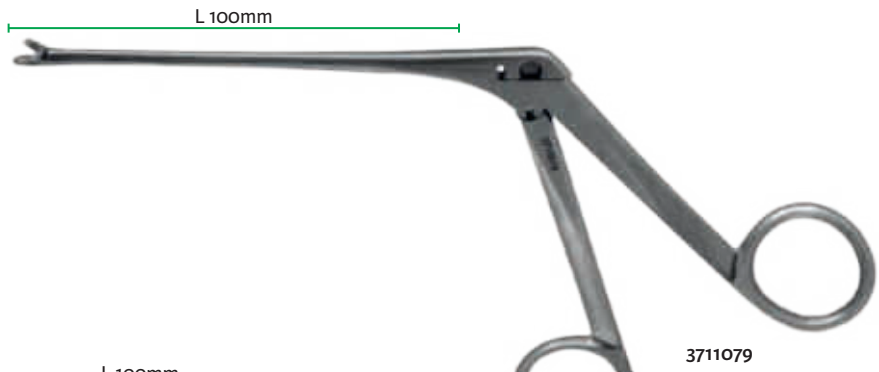

3711079

Blakesley



45°	
3711084	2mm
3711085	2.5mm
3711086	3mm

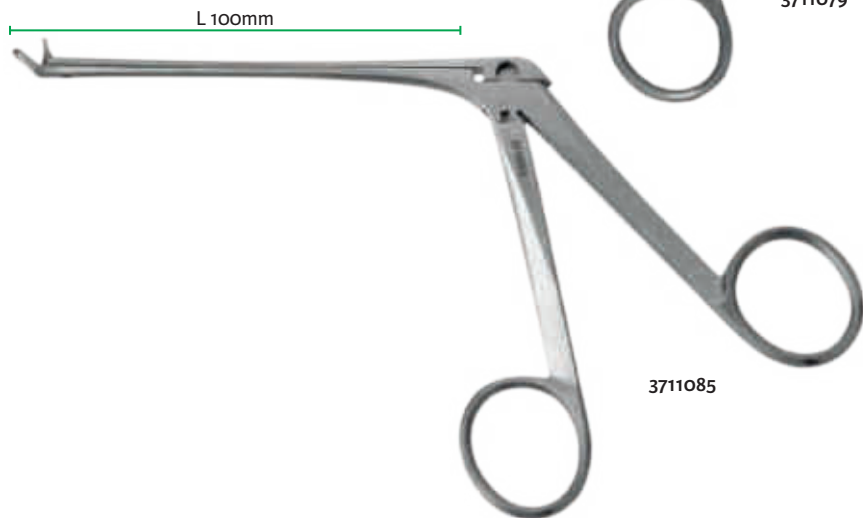

3711085

Weil-Blakesley

serrated jaws



3711200	2mm
3711201	2.5mm
3711210	2.5mm right
3711213	2.5mm left
3711202	3mm

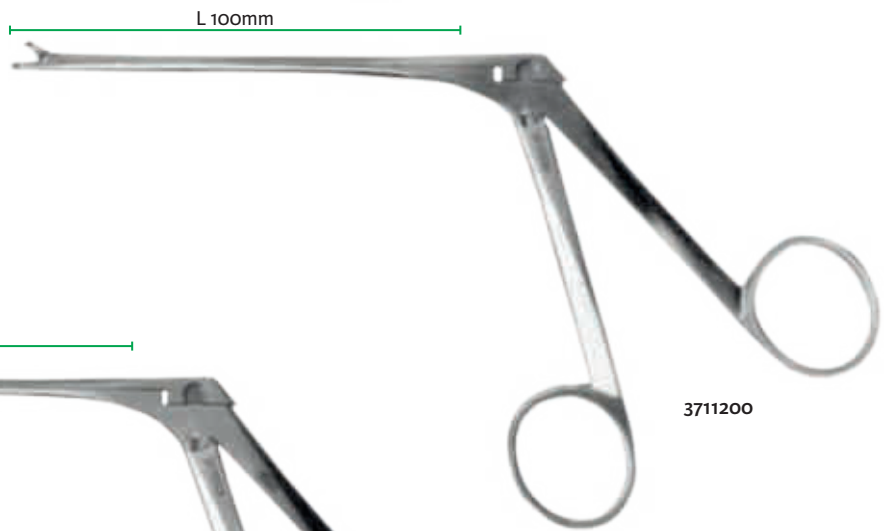

3711200

Weil-Blakesley



45°	
3711203	2mm
3711204	2.5mm
3711205	3mm

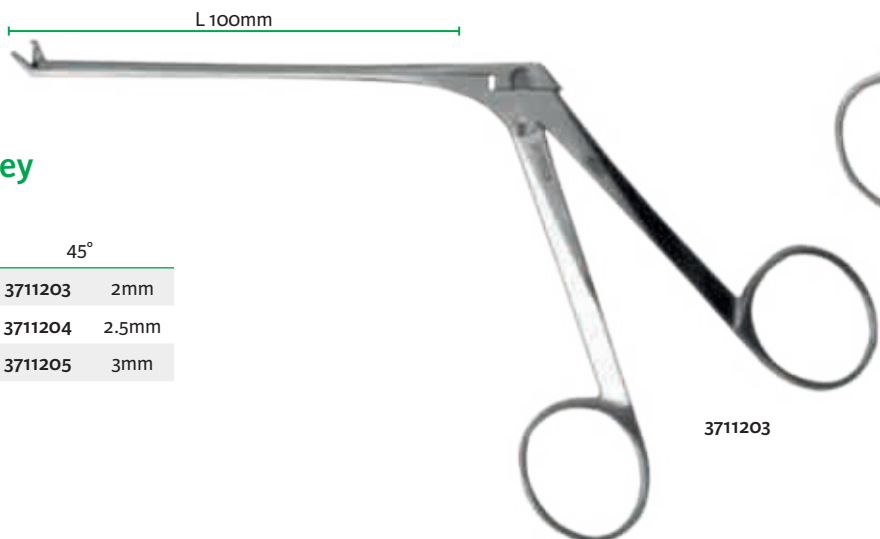

3711203

Struycken

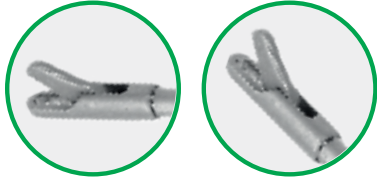

MCEN65	MCEN66
1,5mm straight	1,5mm up 45°

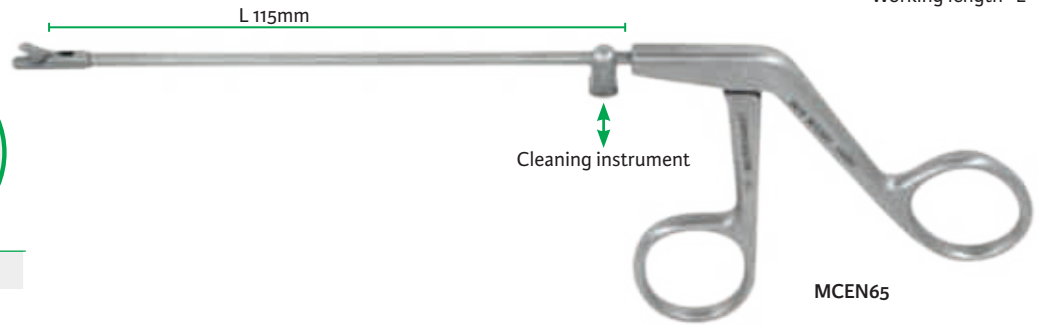

Struycken



MCEN67	MCEN67-1	MCEN67-2
1,5mm	right opening	left opening



Lusk



MCEN73
2,7mm



Scale 2/3

Working length "L"

Gruenwald

L 115mm



Cutting punch forceps

3711011	3.5x11mm
3711012	4x12mm

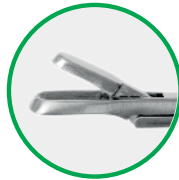

enhanced vision

3711013	3.5x11mm
---------	----------



3711011

Gruenwald

L 130mm



3711089

45°

Clean-bite forceps
serrated jaws

3711082	Straight 2mm
3711083	Straight 2.5mm
3711088	45° 2mm
3711089	45° 2.5mm



3711089

"Girafe"

L 130mm



Thrubite forceps

serrated jaws 2mm - curved up 60°

3712300	horizontal jaws
3712301	vertical jaws

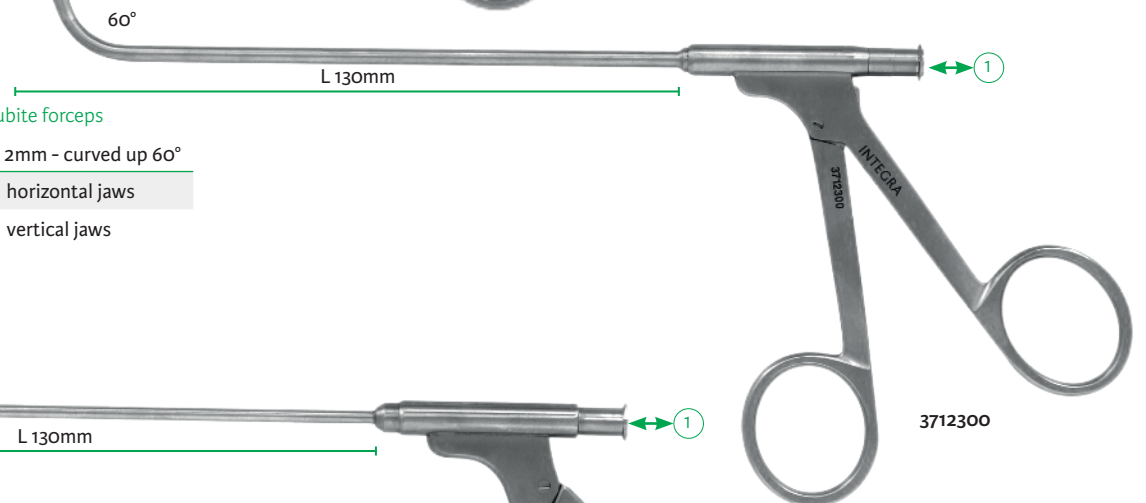

3712300

"Girafe"

L 130mm



3712313

Thrubite forceps

Jaws	vertical	horizontal
45° 2mm	3712310	3712311
90° 2mm	3712312	3712313
45° 3mm	3712314	-

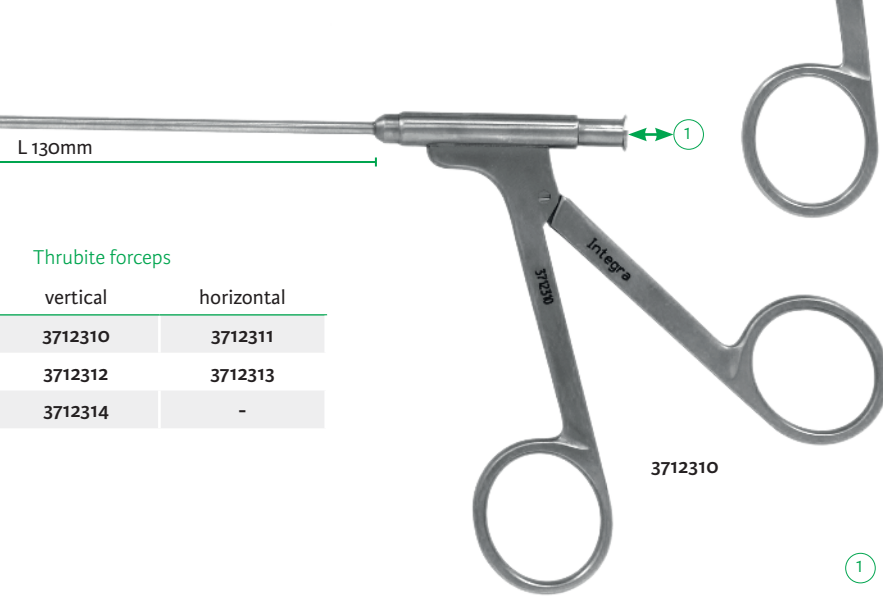

3712310

① Cleaning instrument

Scale 1/3

Working length "L"

Citelli-Peynègre

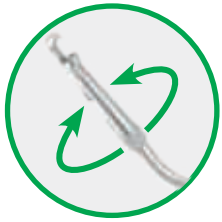

MCE98
3mm

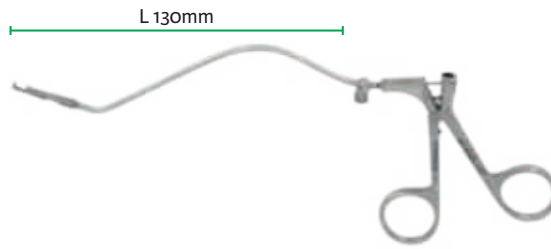

Citelli-Frèche



MCE12
4mm - 45°

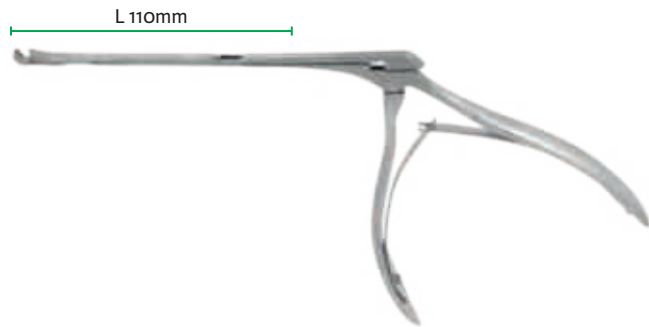

Hajek-Kofler



3712022
rotatable
3x7mm jaws

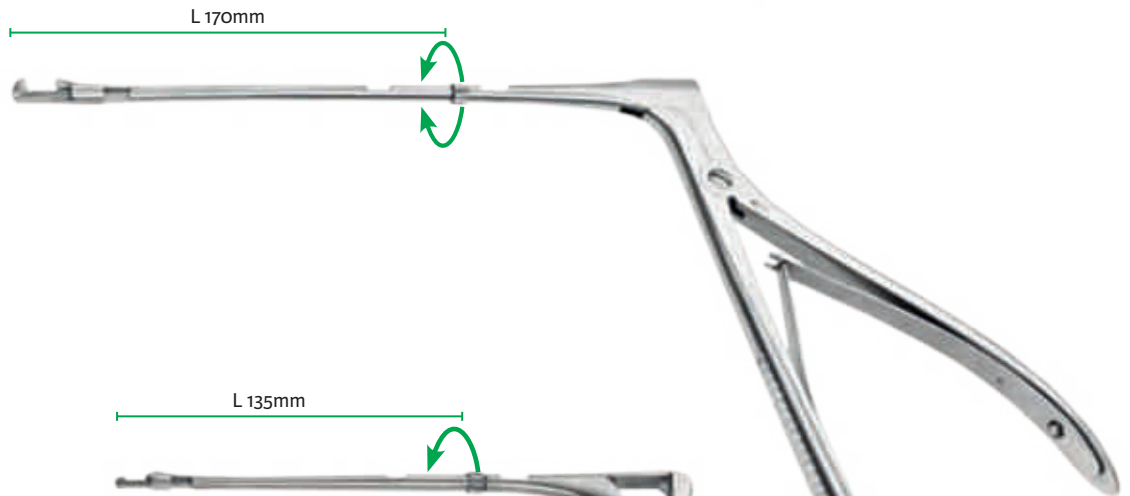

McKenty



3712025
rotatable
2x5mm jaws

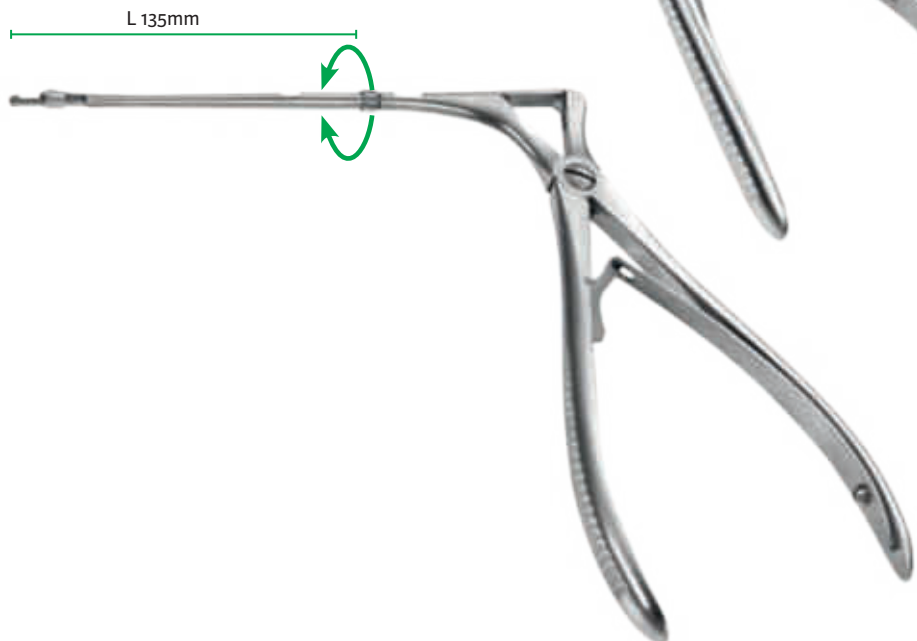

Scale 1/3

Working length "L"



Articulated
70° up

3712118	2x4mm jaws
3712119	3x4mm jaws

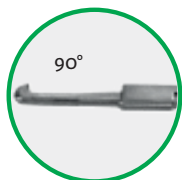
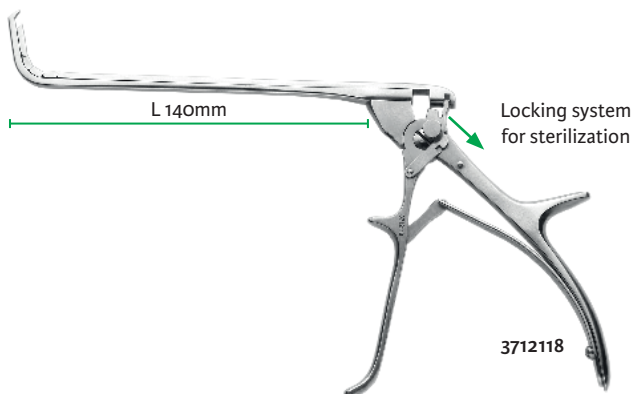

3712026	jaws 2mm	L 175mm
3712027	jaws 3mm	L 150mm

Rongeur with a shaft cleaning port and stylet for ejecting fragments

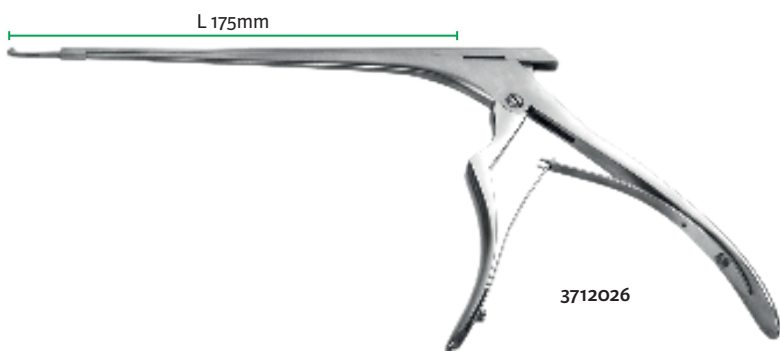

Hajek-Kofler

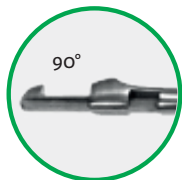

up biting jaws

3712044	90°
	2.5x7mm jaws

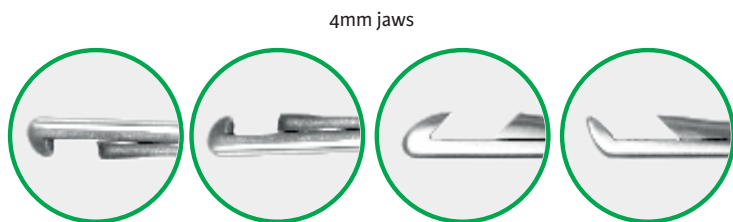
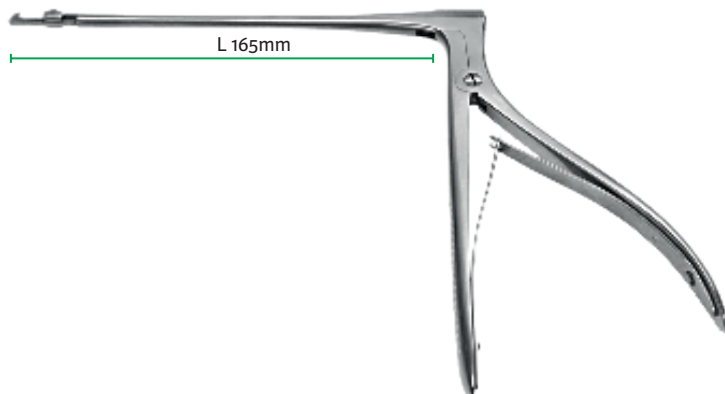

3712023	3712024	3712028	3712029
90° downbiting	90° up biting	45° backward biting	45° forward biting

Scale 1/2

Jankowski

Titanium serrated blades 15mm



MCEN41J

Straight

MCEN42J

Curved left

MCEN42J1

Curved right

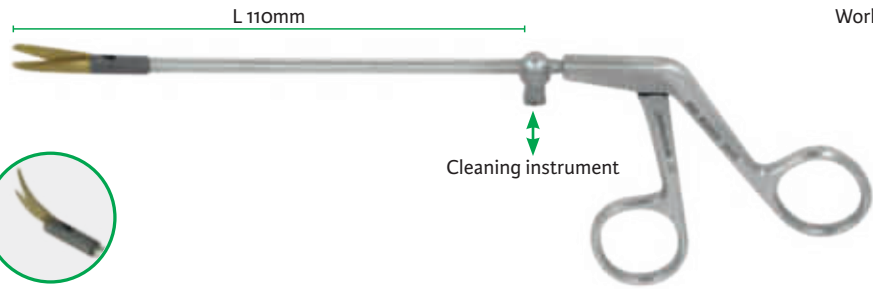

Working length "L"

MCEN41J

Dessi

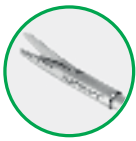

MCEN41D3

Serrated blades 10mm

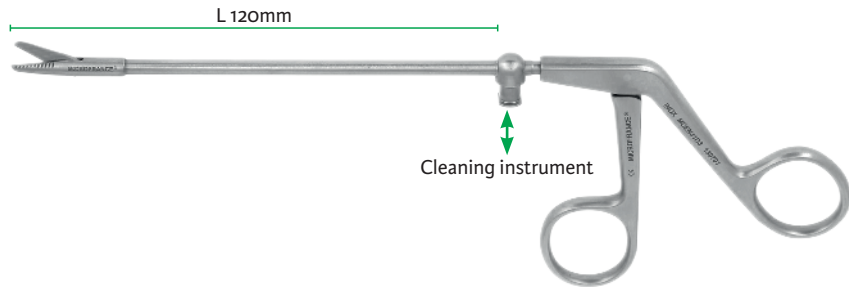

Peynègre



Serrated blades 10mm

MCEN41-1

Straight

MCEN42

Curved left

MCEN42-1

Curved right

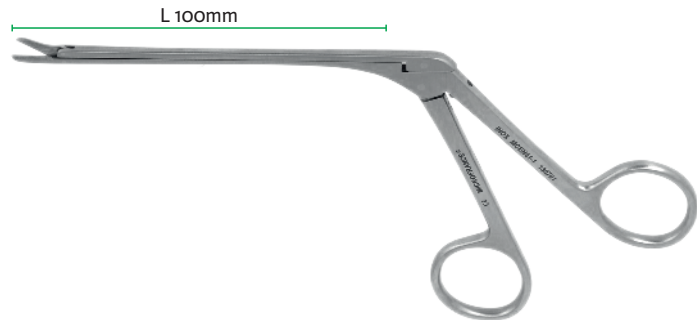

MCEN41-1

Blades 12mm

3713029

Straight

3713030

Curved left

3713031

Curved right

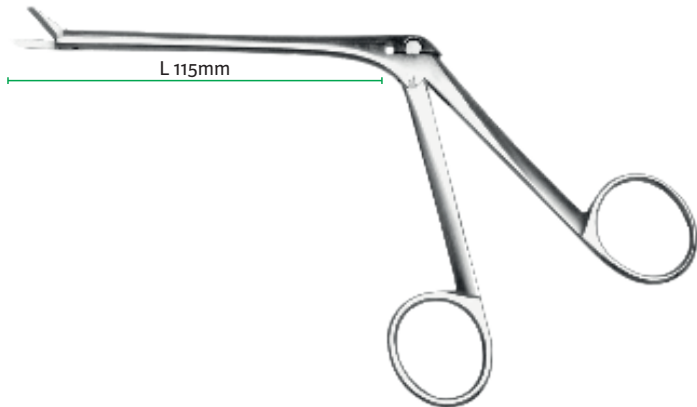

3713029

Blades 8mm - pediatric

3713026

Straight

3713027

Curved left

3713028

Curved right

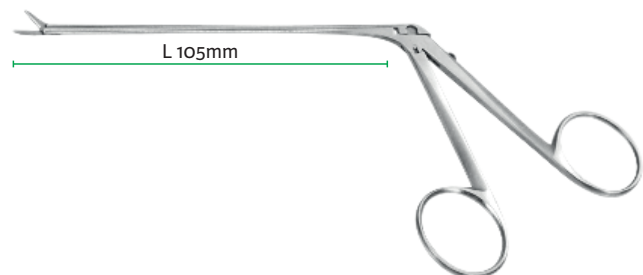

3713026

Scale 1/2

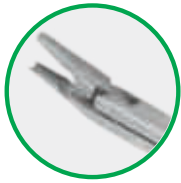

MCEN21
Clip LT200



MCEN21R
Clip LT200

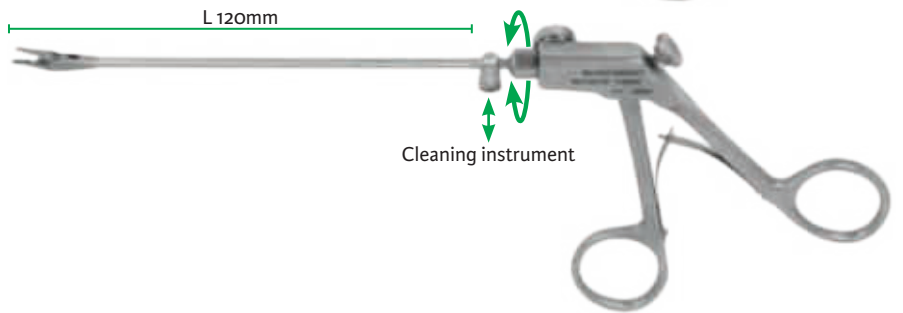

Wormald



MCEN211
Clip LT200



MCEN211S
Clip LT100

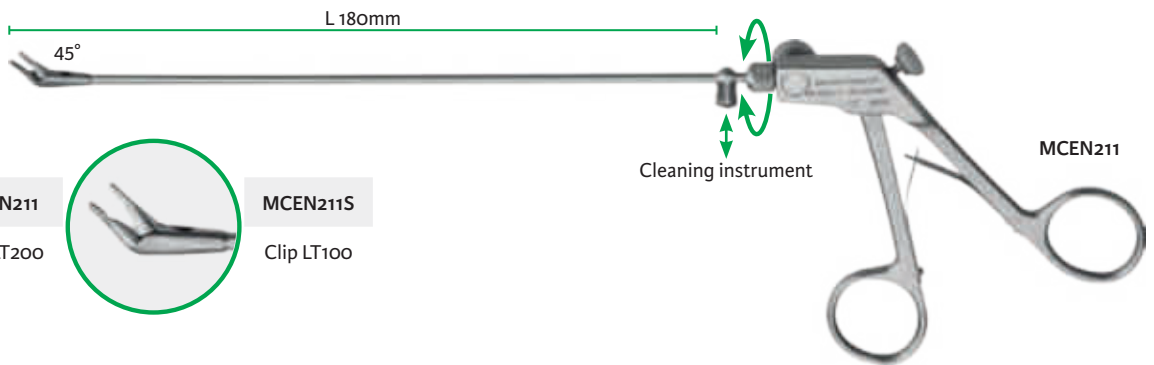

Wormald



MCEN212
Clip LT200

MCEN212S
Clip LT100

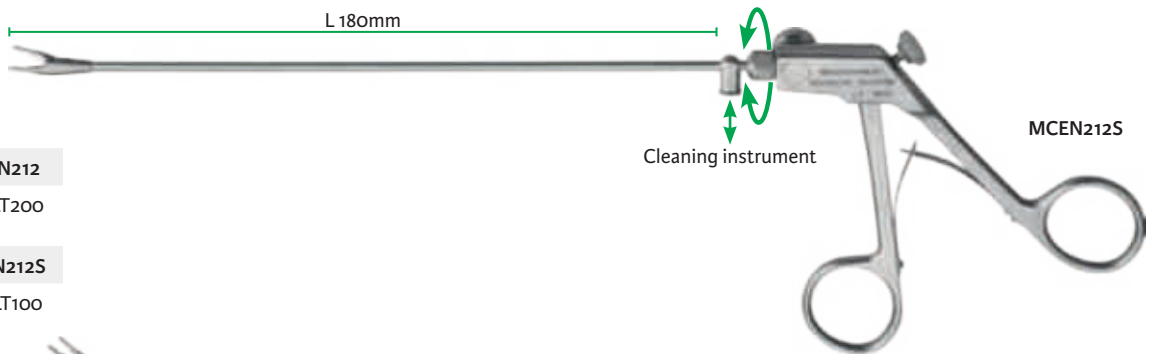

Wormald



MCEN213
Clip LT200

MCEN213S
Clip LT100

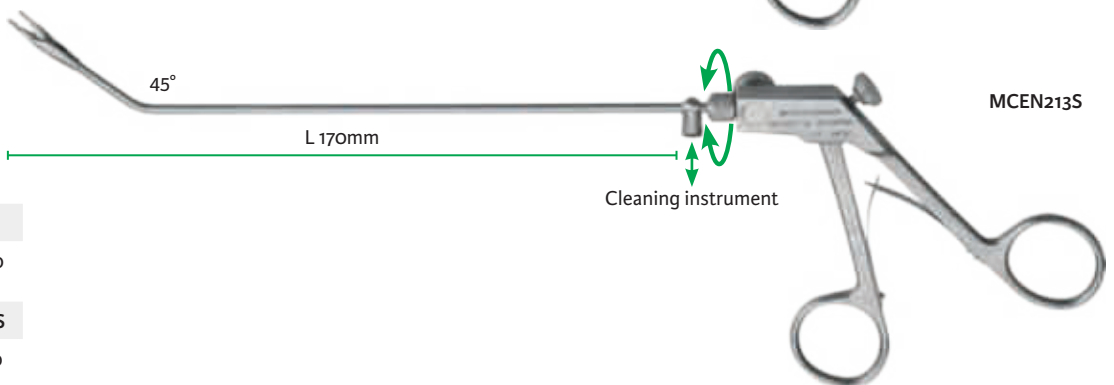

Bipolar forceps, 1 piece instrument

Scale 2/3

Working length "L"

Dessi

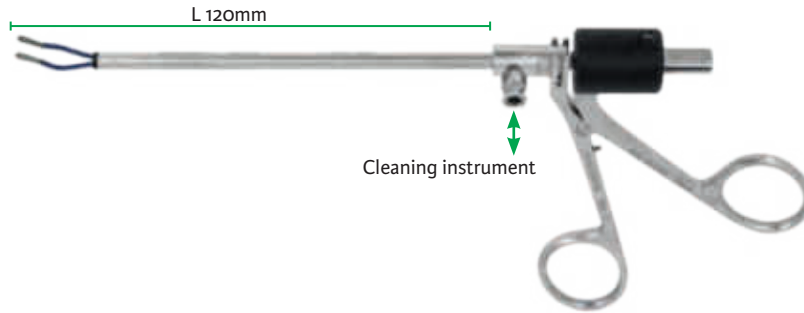

MCEN54

Bipolar forceps, 3-piece instrument

Dessi

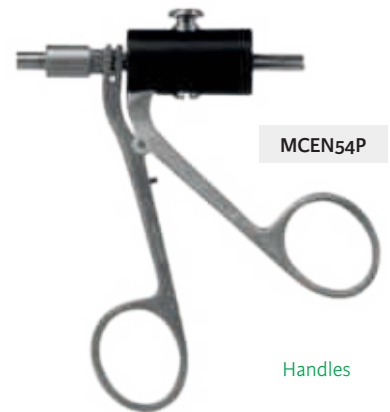
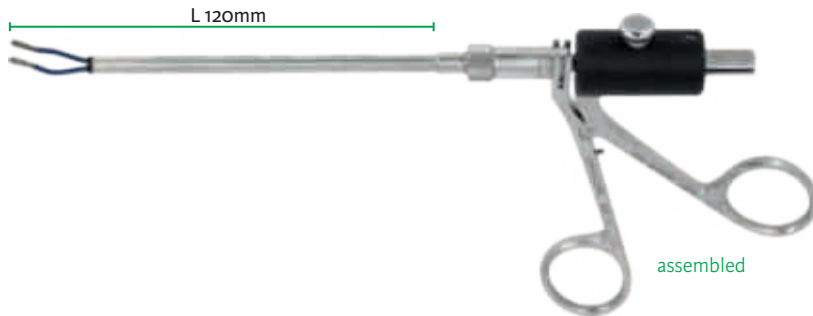

MCEN54G



Tube

MCEN54I



Insert

MCEN54H



Herman
Insert

CEV669BG

Bipolar cables - 4.5 m

- CP393-2**
Bowa Emc Lamidey Valleylab

- CP393-3**
Erbe VIO ICC ACC (except international) Storz Wolf

- CP393-4**
Aesculap Berchtold Martin Sutter BM-780 II



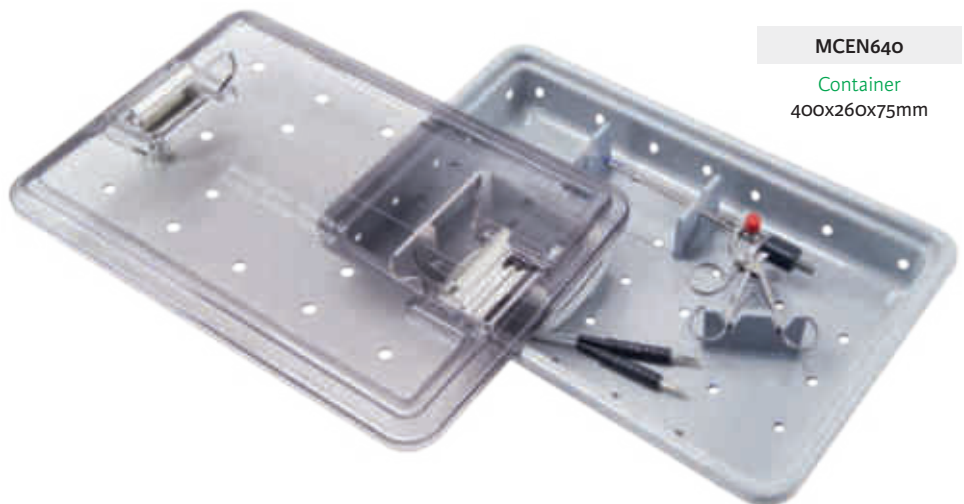

MCEN64o

Container
400x260x75mm

Scale 1/2

Working length "L"

Wormald

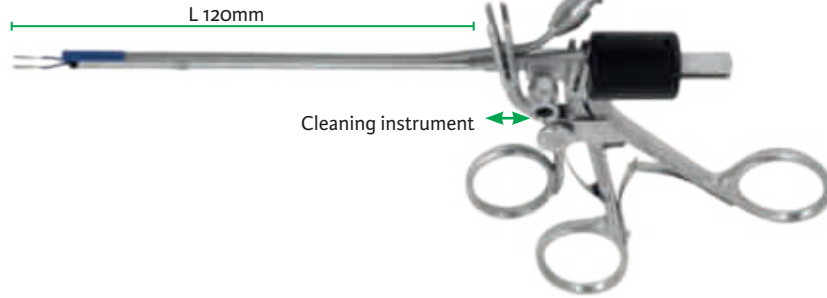

MCEN64

Wormald

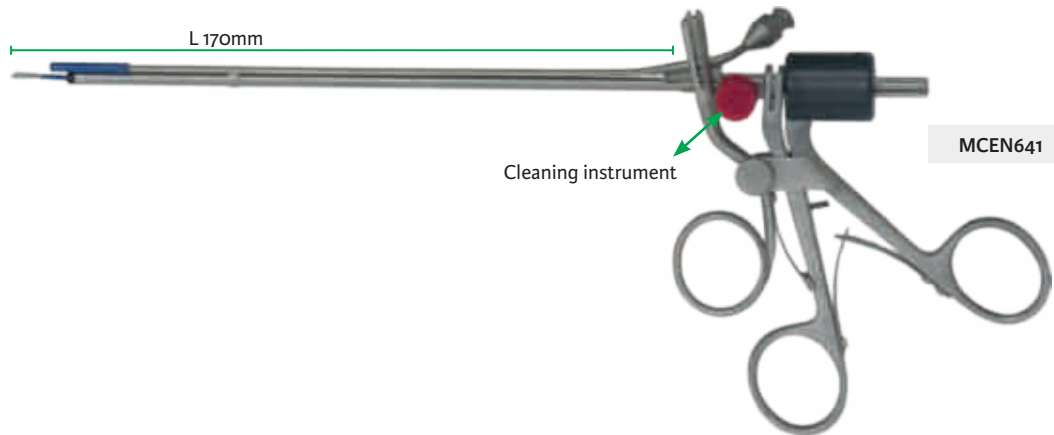
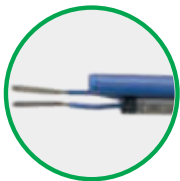

MCEN641

Wormald

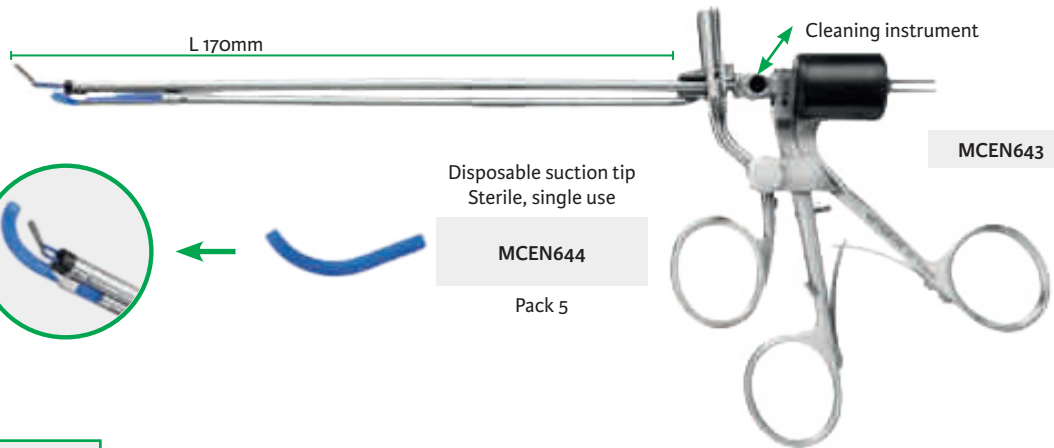

MCEN643

Disposable suction tip
Sterile, single use

MCEN644

Pack 5

Bipolar cables - 4.5 m

- CP393-2**
Bowa Emc Lamidey Valleylab
- CP393-3**
Erbe VIO ICC ACC (except international) Storz Wolf
- CP393-4**
Aesculap Berchtold Martin Sutter BM-78o II



MCEN640

Container
400x260x75mm

Hook

Working length "L"

Scale 1/2

Frèche



90°

L 70mm



200mm

MCEN101

Herman



90° - 5mm

L 125mm



245mm

MCEN128

Suction tube elevator with finger control

Appelbaum



Ø2mm

L 65mm

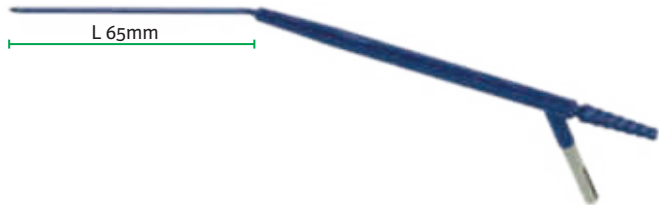

170mm

MCEN730

Suction tube with finger control

Frèche

MCEN100-2-0	2mm
MCEN100-2-5	2.5mm
MCEN100-3-0	3mm
MCEN100-3-5	3.5mm

L 145mm



200mm

MCEN100-2-5

Lancet knife

Frèche

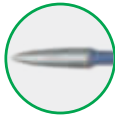

L 140mm

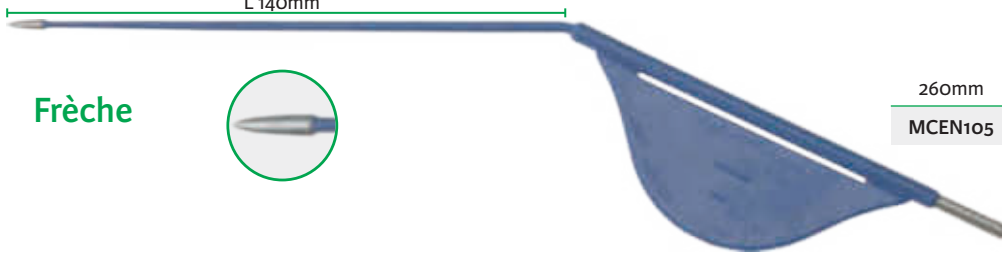

260mm

MCEN105

Picks

Rouvier

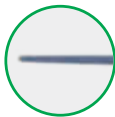

L 110mm

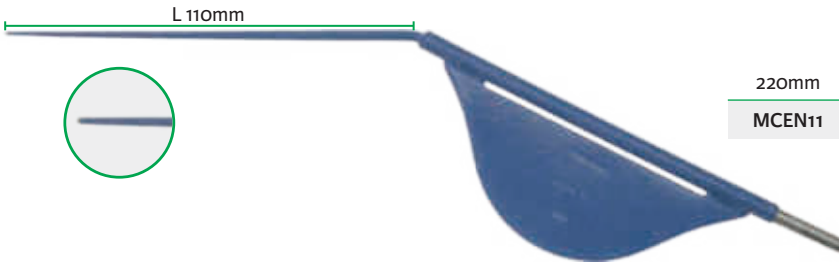

220mm

MCEN11

Rouvier



L 110mm

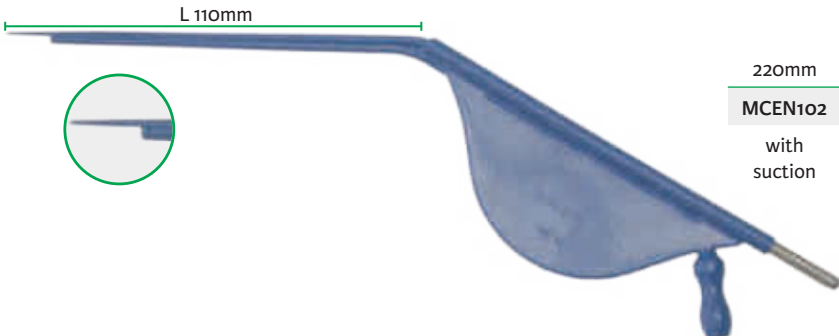

220mm

MCEN102

with suction

Monopolar cables - 3.5 m



CP391E

Erbe ACC ICC/VIO Storz Wolf



CP391M

Aesculap Berchtold Martin Erbe T Serie
Lamidey Sutter BM-780 II



CP391V

Bowa Bovie Conmed Valleylab

Drill with adjustable thrust

Hand drill



Scale 1/1 7777 85mm Ø 2mm



^(D) Distributed by Integra MicroFrance SAS (France)
For corresponding manufacturer part numbers, see table in annex

Working length "L"

Nail

Lemoine

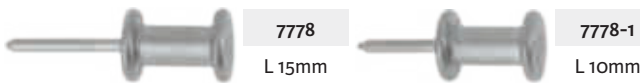

Scale 1/1

Klossek



Kennedy Instrumentation - 150mm length

Kennedy

Working length "L"

Scale 1/1



Knife and suction tube

Scale 1/2

Working length "L"

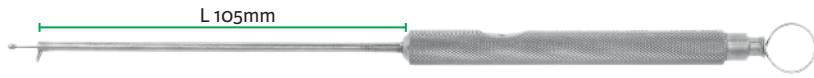

MCEN111
205mm



MCEN111 4mm - 80°	MCEN112 4mm - 90°	MCEN120 4mm - 135°
----------------------	----------------------	-----------------------

Thru-flow suction cup forceps

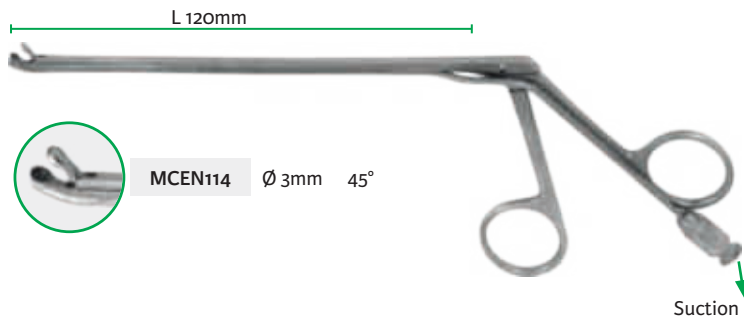

MCEN114 Ø 3mm 45°

Suction tube with finger control 170mm length

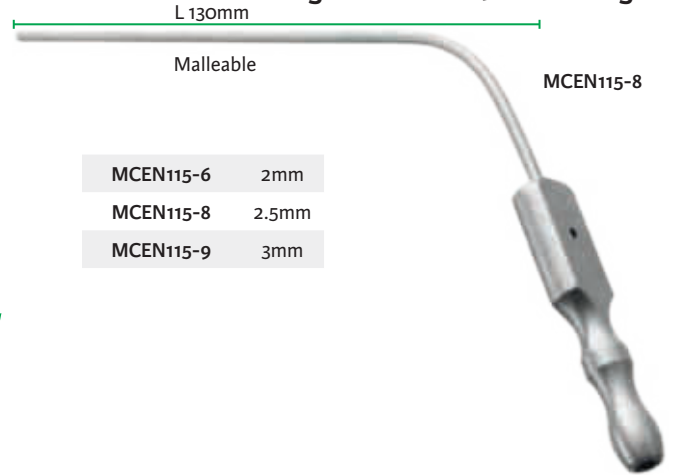

MCEN115-6	2mm
MCEN115-8	2.5mm
MCEN115-9	3mm

Cleaning device



MCEN110
4 > 4mm
6 > 6mm

Cutting circular punch

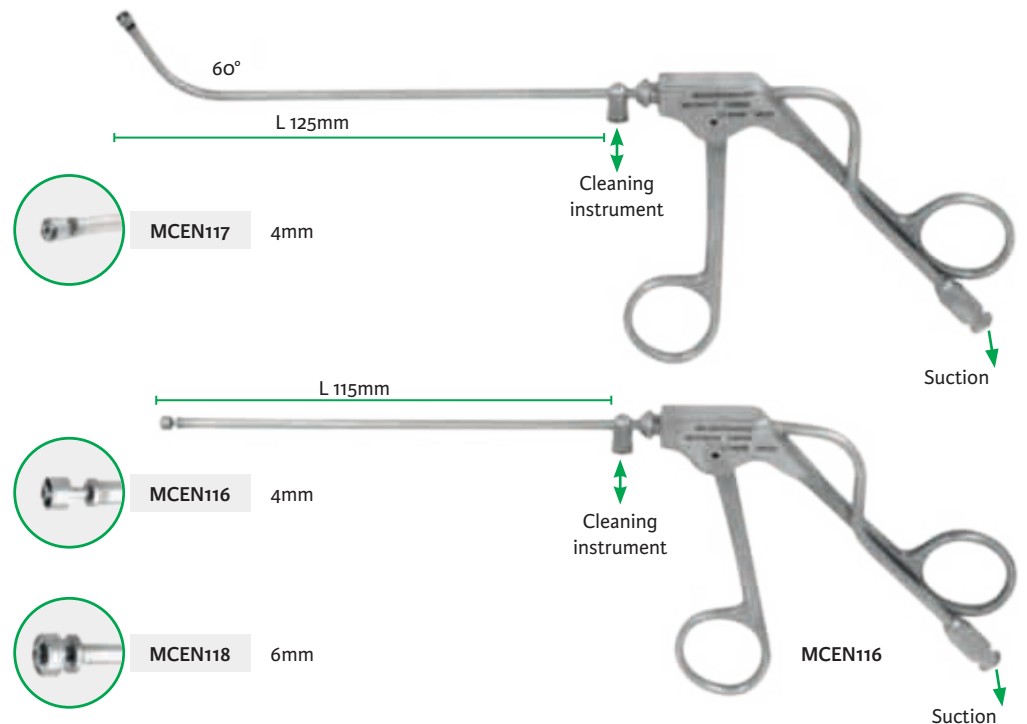

MCEN117 4mm



MCEN116 4mm



MCEN118 6mm

MCEN116

Scale 2/3

Suction curette with finger control

Working length "L"

150mm - Ø 3.5mm

MCEN768 Curette 90°

MCEN769 Curette 60°



Double knife

190mm

MCEN720



240mm

MCEN760



240mm

MCEN761



Double palpation probe, Double ended seeker

Double-ended seeker

195mm

MCEN721



190mm

MCEN723



Double-ended palpation probe

245mm

MCEN762



245mm

MCEN763



Angled palpation probe



MCEN155 180mm

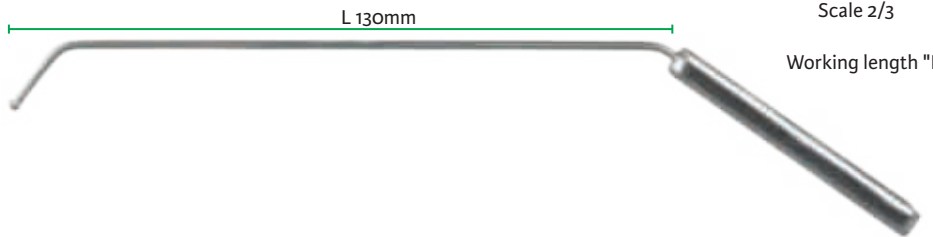

Scale 2/3
Working length "L"

Angled elevator



MCEN157 180mm

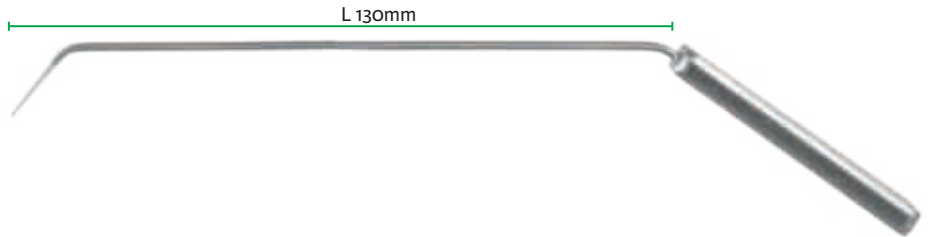

Blunt suction tube



MCEN156 185mm
Ø 2mm

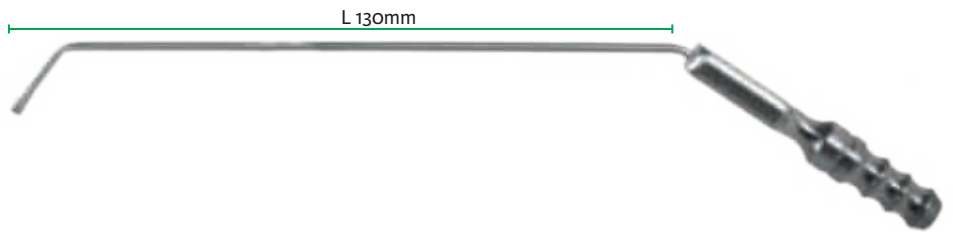

Angled suction tube elevator



MCEN158 185mm
Ø 2mm

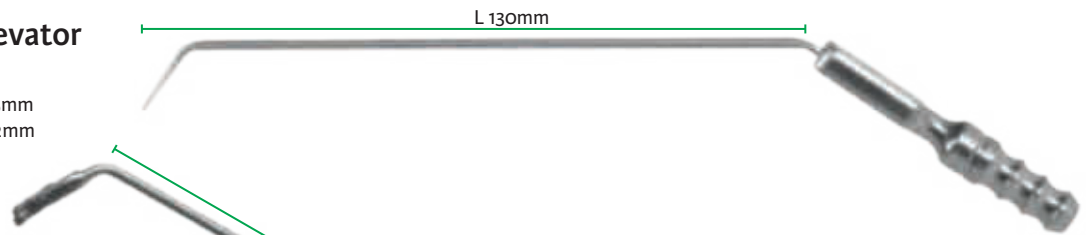

Cup forceps

curved down 45°



MCEN151
vertical



MCEN152
horizontal

Thru-cutting forceps



MCEN153
vertical



MCEN154
horizontal

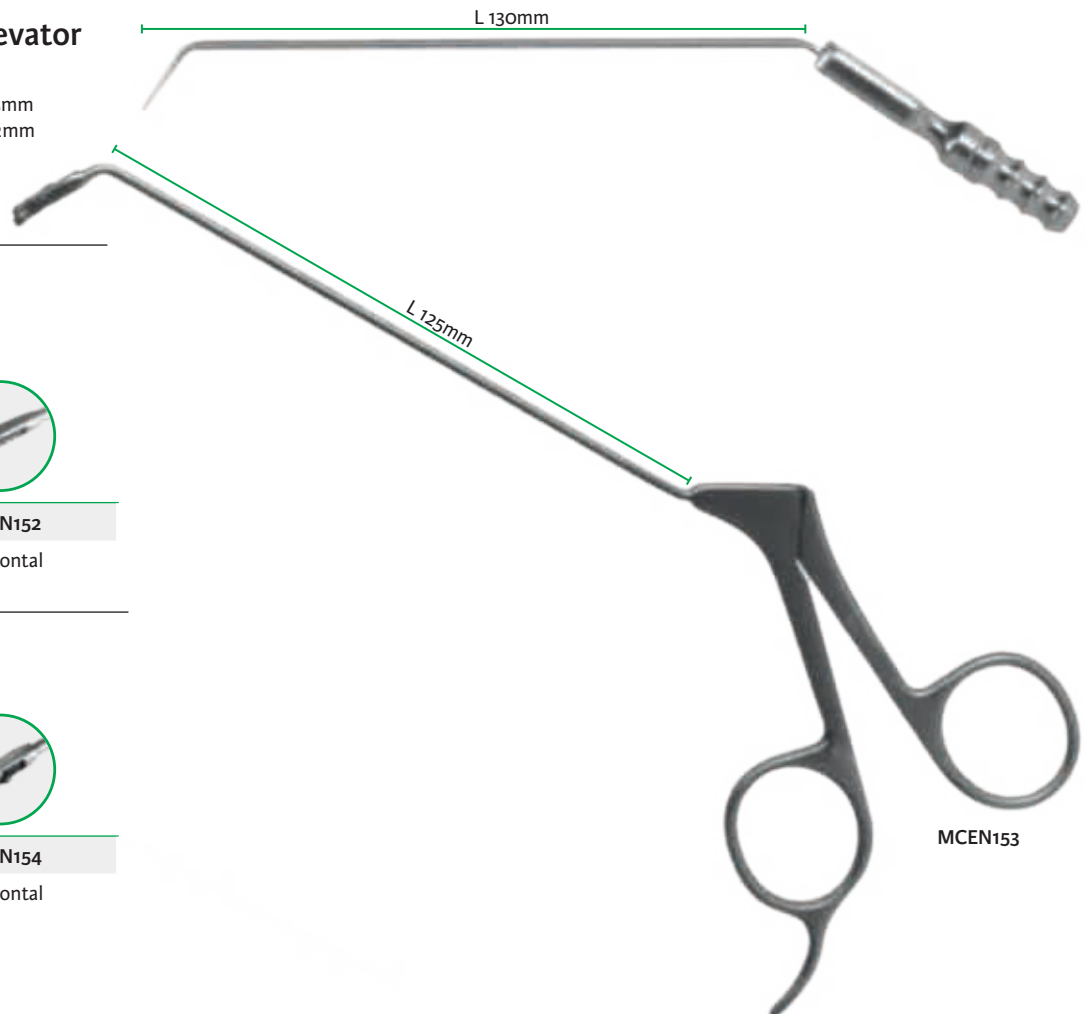

MCEN153

Scale 2/3

Working length "L"

Blunt loop, Knife and suction tube, suction curette

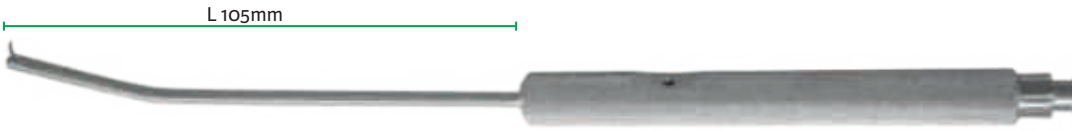

210mm
MCEN165



Blunt loop

MCEN161
135° - Ø 3mm



Knife and suction tube

MCEN163
90° - Ø 3mm



MCEN164
135° - Ø 3mm



MCEN165
45° - Ø 3mm



Suction curette

MCEN167
90° - Ø 3mm

Knife, Sickle knife, Loop, curved shaft



MCEN168



Knife
90°

MCEN162
180mm



Sickle knife
curved

MCEN168
225mm



Blunt loop
70°

MCEN170
250mm

Double ended perforator elevator



Perforator

250mm
MCEN171

Elevator



Forceps

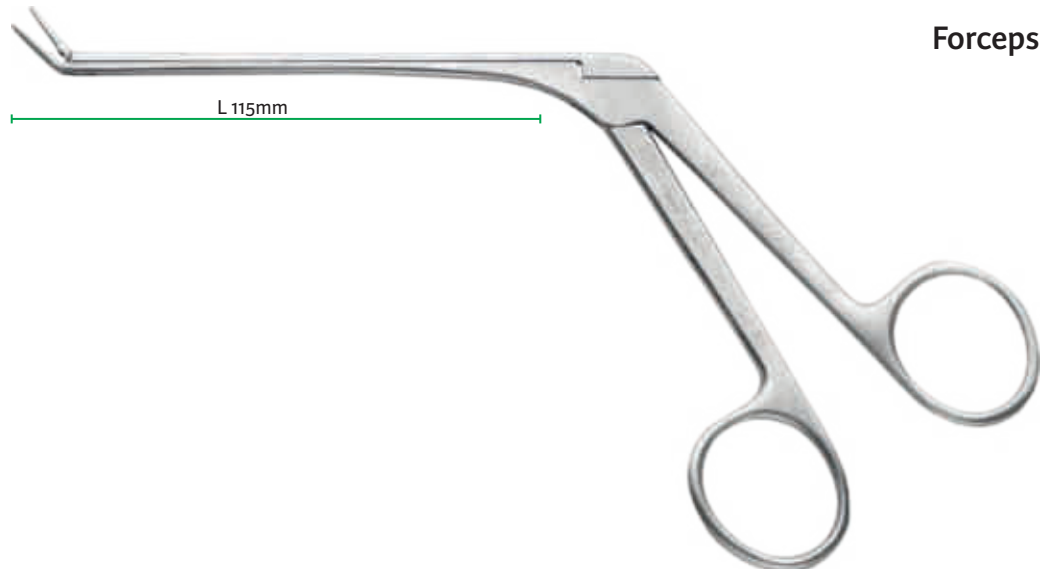

L 115mm



Serrated jaws

MCEN169
3x12mm

Palpation probe, Suction tube, Suction tube elevator

Scale 2/3

Working length "L"

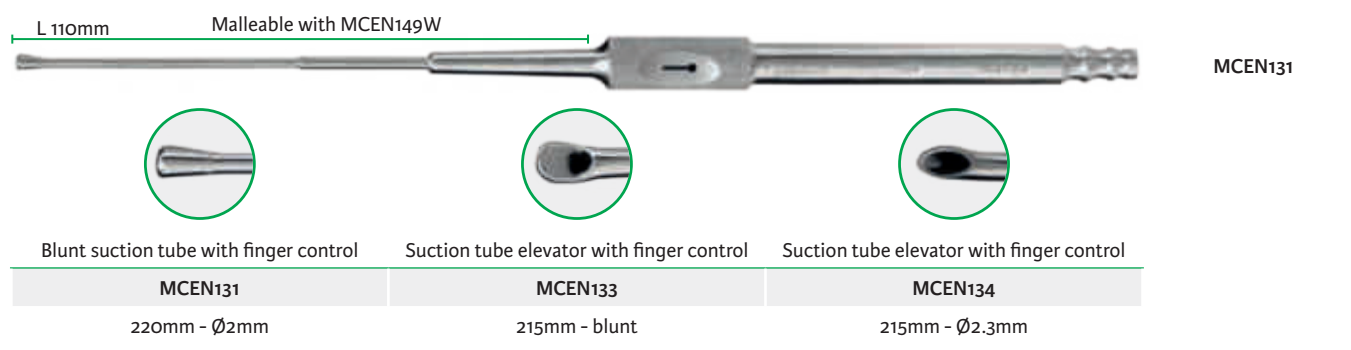

Knot pusher

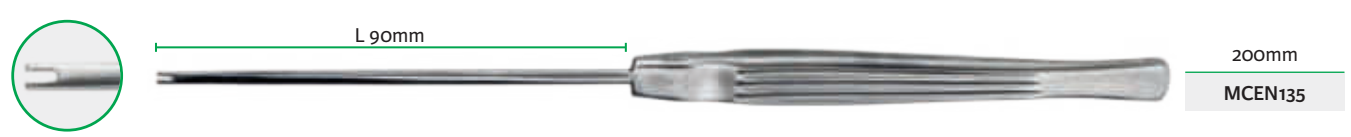

Sterilization case



Scale 1/2

Palpation probe, Suction curette, Basket suction tube, Suction tube elevator

Working length "L"



MCEN142

Suction tube with finger control

Suction curette with finger control

Basket suction tube with finger control

Suction tube elevator with finger control



MCEN138	MCEN138S	MCEN140	MCEN140A	MCEN141	MCEN141A	MCEN142	MCEN147
Ø 3.5mm	Ø 2mm	Ø 2.5mm	Ø 2.5mm	Ø 2.5mm	Ø 2.5mm	Ø 2.5mm	Ø 2.5mm
		45°	45°	90°	90°		
		4x5mm	5x6mm	4x5mm	5x6mm		

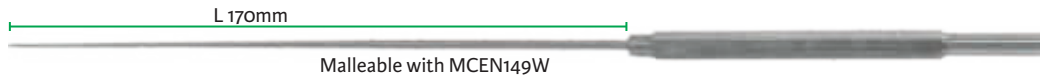

MCEN139A

Palpation probe



MCEN139

MCEN139A

90°

Straight



Suction tube modelling lever

MCEN149W

150mm

Scissors, forceps

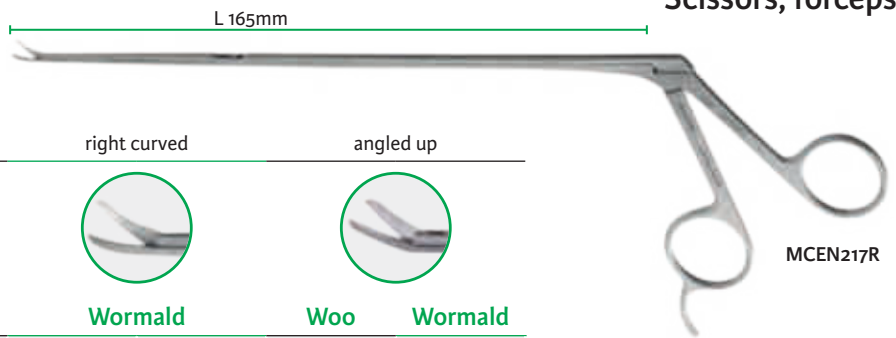

MCEN217R

Scissors

straight

left curved

right curved

angled up



Woo

Wormald

Wormald

Wormald

Woo

Wormald

MCLW10	MCEN217S	MCEN216L	MCEN217L	MCEN216R	MCEN217R	MCLW11	MCEN217U
5mm	8mm	5mm	8mm	5mm	8mm	5mm	8mm

Fenestrated cup forceps, 230mm



MCEN214

MCEN215

straight jaws
1.5x3.5mm

45° jaws
1.5x3.5mm

Needle-holder, tungsten

Scale 1/2

Working length "L"



MCEN218

tungsten

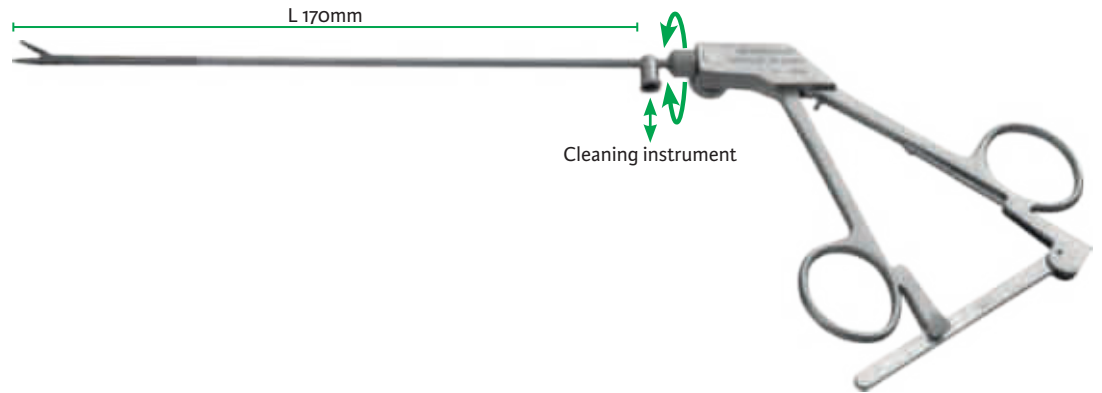

Debaquey clamp, rotatable



MCEN191



MCEN192

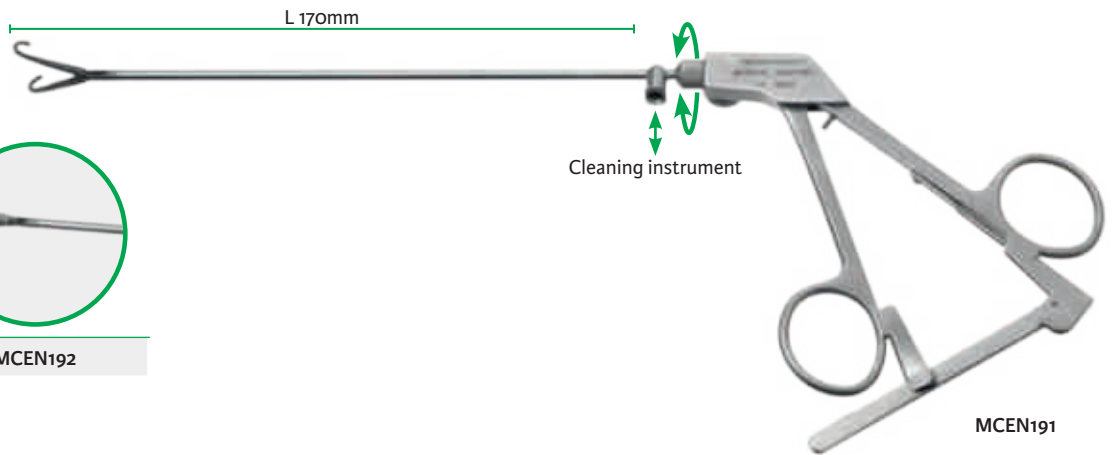

MCEN191



MCEN190

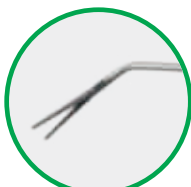

MCEN193

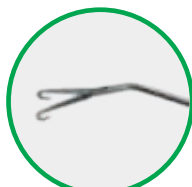

MCEN194



MCEN195

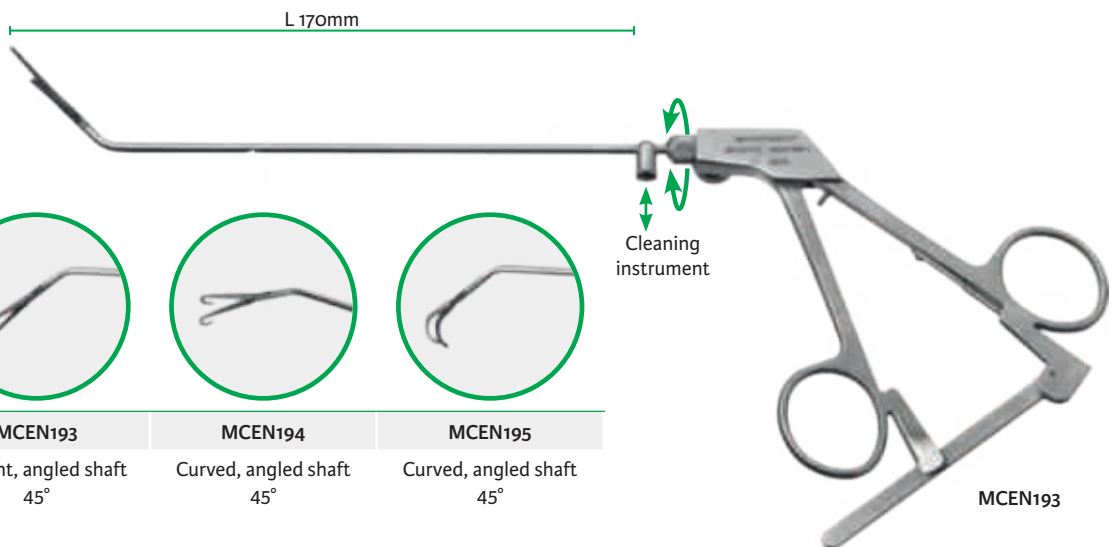

MCEN193

Straight, angled shaft
20°

Straight, angled shaft
45°

Curved, angled shaft
45°

Curved, angled shaft
45°

Scale 1/2

Working length "L"

Suction tube with finger control

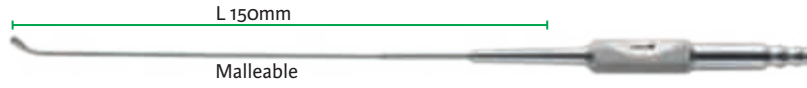

210mm
MCEN349



MCEN347

MCEN348

MCEN349

Ø 2mm

Ø 1.5mm

Ø 2mm

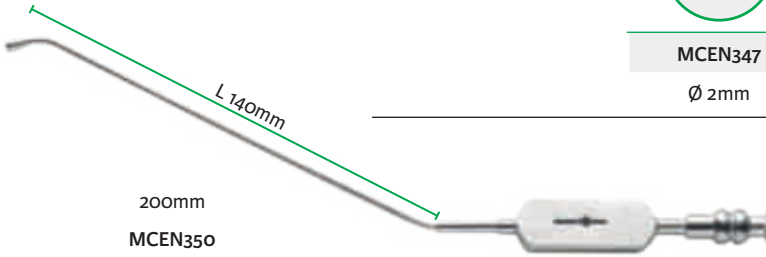

Suction tube, angulated

MCEN350	MCEN351
curved down Ø 2mm	curved up Ø 2mm

Hook, Ball probe, Elevator



230mm
MCEN345

Hook

Ball probe

Elevator



MCEN329

MCEN330

MCEN345

MCEN346

Ø 1.5mm

Ø 3mm

Ø 2mm

Ø 4mm

Cup forceps, scissors, bipolar forceps with stylet handle

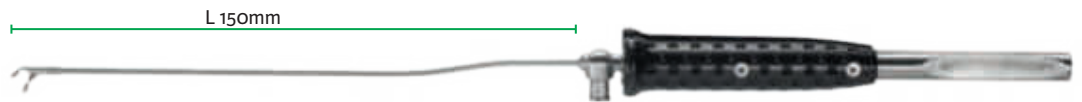

Cup forceps

280mm
MCEN328U

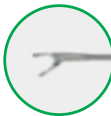

MCEN328S

straight
Ø 2.5mm



MCEN328U

up
Ø 2.5mm

Scissors

280mm
MCEN344U



MCEN344S
5mm - straight



MCEN344U
5mm - 45°



MCEN344V
5mm - curved left

Bipolar forceps

300mm
MCEN365



MCEN364

45° - 1x5mm



MCEN365

Bayonet jaws

Bipolar cables - 4.5 m

CP393-2
Bowa Emc
Lamidey
Valleylab



CP393-3
Erbe VIO ICC
ACC (except
international)
Storz Wolf



CP393-4
Aesculap
Berchtold
Martin Sutter
BM-780 II





Scale 1/2

Stainless steel cup

7876-60 ^(D)	60mm
7876-80 ^(D)	80mm
7876-100 ^(D)	100mm
7876-120 ^(D)	120mm
7876-160 ^(D)	160mm



Stainless steel tray

7872-24 ^(D)	240x180mm
------------------------	-----------

Scale 1/4



Surgical instrument paraffin oil

MCO731^(D)

Stainless steel sterilization case

Scale 1/5



7874MF-22

240x105x45mm
220x100x40mm

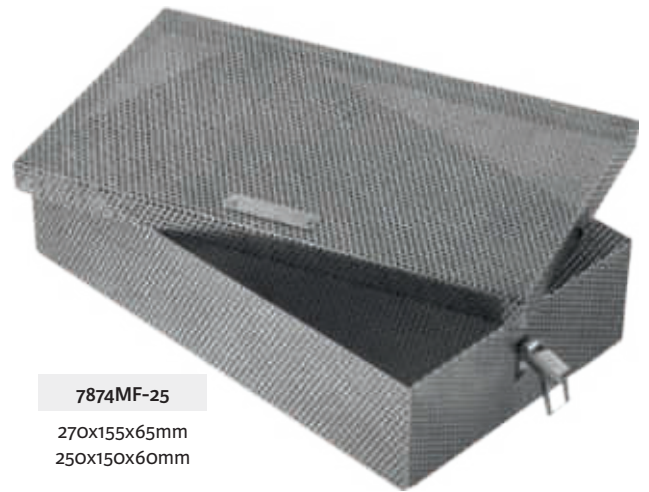

7874MF-25

270x155x65mm
250x150x60mm

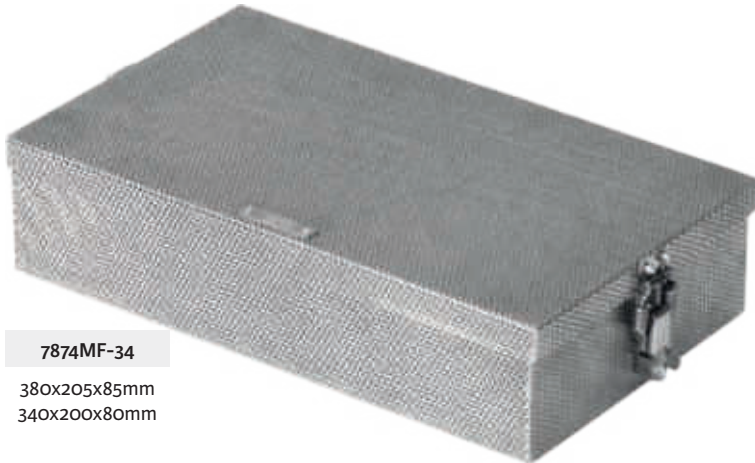

7874MF-34

380x205x85mm
340x200x80mm



7874MF-40

440x205x95mm - 400x200x90mm

^(D)Distributed by Integra MicroFrance SAS (France) - For corresponding manufacturer part numbers, see table in annex

Scale 1/3



Wormald

MCEN136SC

290x175x55mm
270x160x35mm



Toriumi

3717011

528x250x123mm



Numerical index

1

1003IG ^(D)	18
1003LI ^(D)	18
1004IG ^(D)	18
1005I ^(D)	18
1352431.....	85
1375012.....	81
1375020.....	81
1375025.....	81
1375101.....	81
1375102.....	81
1375103.....	81
1375107.....	81
1375110.....	81
1375114.....	81
1375201.....	81
1375207.....	81
1375210.....	81
1375214.....	81

3

3711011.....	103
3711012.....	103
3711013.....	103
3711014.....	12
3711017.....	91
3711018.....	91
3711020.....	91
3711021.....	91
3711022.....	12
3711026.....	47
3711027.....	47
3711029.....	49
3711032.....	43
3711035.....	93
3711036.....	93
3711037.....	93
3711038.....	92
3711039.....	92
3711040.....	92
3711041.....	92
3711043.....	92
3711044.....	92
3711045.....	92
3711047.....	92
3711048.....	92
3711049.....	96
3711050.....	96
3711053.....	96
3711054.....	96
3711055.....	96
3711056.....	96

3711057.....	97
3711059.....	97
3711060.....	96
3711061.....	96
3711062.....	96
3711063.....	96
3711064.....	96
3711065.....	96
3711067.....	97
3711068.....	96
3711069.....	96
3711071.....	95
3711072.....	92
3711073.....	92
3711074.....	92
3711076.....	92
3711077.....	91
3711078.....	91
3711079.....	101
3711080.....	101
3711081.....	101
3711082.....	103
3711083.....	103
3711084.....	101
3711085.....	101
3711086.....	101
3711088.....	103
3711089.....	103
3711105.....	12
3711108.....	12
3711109.....	91
3711113.....	87
3711114.....	87
3711118.....	92
3711119.....	92
3711127.....	95
3711128.....	95
3711129.....	97
3711130.....	97
3711140.....	101
3711141.....	101
3711200.....	101
3711201.....	101
3711202.....	101
3711203.....	101
3711204.....	101
3711205.....	101
3711210.....	101
3711213.....	101
3712002.....	46
3712003.....	46
3712008.....	46
3712012.....	98
3712013.....	99
3712015.....	44
3712016.....	44
3712017.....	44
3712021.....	44
3712022.....	104
3712023.....	105
3712024.....	105
3712025.....	104
3712026.....	105
3712027.....	105
3712028.....	105
3712029.....	105
3712030.....	100
3712031.....	100
3712032.....	98
3712033.....	98
3712034.....	98
3712037.....	99
3712038.....	100
3712039.....	100
3712040.....	100
3712043.....	98
3712044.....	105
3712107.....	100
3712108.....	100
3712116.....	100
3712117.....	100
3712118.....	105
3712119.....	105
3712300.....	103
3712301.....	103
3712310.....	103
3712311.....	103
3712312.....	103
3712313.....	103
3712314.....	103
3713001.....	56
3713002.....	60
3713012.....	51
3713013.....	54
3713020.....	48
3713024.....	56
3713025.....	48
3713026.....	106
3713027.....	106
3713028.....	106
3713029.....	106
3713030.....	106
3713031.....	106
3713054.....	60
3713059.....	56
3713063.....	48
3714001.....	77
3714002.....	77

^(D) Distributed by Integra MicroFrance SAS (France) - For corresponding manufacturer part numbers, see table in annex

3714003	77	3714230	29	3755114	73
3714004	77	3714231	85	3755116	73
3714006	77	3714232	85	3755117	73
3714019	23	3714237	80	3755136	73
3714020	26	3714238	80	3755160	75
3714021	26	3714239	80	3755161	75
3714023	26	3714240	80		
3714024	23	3714250	77		
3714025	23	3714282	86	7	
3714026	23	3714284	29	702T	71
3714027	24	3714285	29	703T	71
3714028	24	3714317	29	704T	71
3714038	15	3714320	32	713T	61
3714040	15	3714338	37	714T	71
3714055	32	3714364	23	7706MF	2
3714056	32	3714379	84	7717C	2
3714057	32	3714383	17	7719-2	3
3714058	32	3714401	41	7722-3	2
3714059	37	3714472	8	7726MF	10
3714060	37	3714476	6	7727	10
3714076	33	3714479	6	7728	10
3714077	33	3714480	8	7731	3
3714091	37	3714481	8	7732-1	10
3714092	37	3714482	8	7733	10
3714096	37	3714660	15	7734	10
3714097	34	3714672	39	7742-1	2
3714098	34	3714678	19	7742-2	2
3714099	34	3717011	121	7742-3	2
3714107	23	3718010	86	7746A ^(D)	2
3714108	23	3718020	86	7746B ^(D)	2
3714109	23	3724059	20	7749	11
3714111	23	3724060	20	7750	11
3714148	41	3724074	44	7761-1	11
3714149	41	3724256	23	7761-2	11
3714150	41	3740009	43	7761B-1	11
3714152	41	3740012	62	7761B-2	11
3714153	41	3740015	65	7761BC1	11
3714164	19	3740019	65	7761BC2	11
3714166	19	3740028	63	7761BC3	11
3714173	19	3740038	63	7761C1	11
3714179	25	3740049	65	7761C2	11
3714182	26	3740067	65	7761C3	11
3714183	26	3740090	67	7762-1	92
3714187	26	3741154	60	7762-2	92
3714199	5	3744027	71	7762-5	87
3714200	5	3755000	75	7762A-1	92
3714201	5	3755001	75	7762A-2	92
3714203	6	3755010	74	7762A4	89
3714204	5	3755101	72	7762A-5	87
3714205	8	3755102	72	7762B-1	92
3714213	8	3755106	72	7763	93
3714223	29	3755107	72	7763-1	93
3714224	29	3755110	72	7763-2	93
3714229	29	3755111	72	7764	44

(D) Distributed by Integra MicroFrance SAS (France) - For corresponding manufacturer part numbers, see table in annex

7765	49
7766	30
7768	22
7768-1	22
7771	83
7771AS10 ^(D)	83
7771B	83
7774	28
7776 ^(D)	111
7777	111
7778	111
7778K	111
7778K1	111
7779MF-1	13
7779MF-2	13
7779MF-3	13
7779MF-5CC	13
7782-1-2	24
7783-12	13
7787-10	20
7831A-12	62
7831A-15	64
7831A-18	66
7831A-20	68
7832	68
7833A-12	62
7833A-15	64
7833A-18	66
7833A-20	68
7834	68
7866-13	75
7867-1	72
7867-2	72
7867-3	72
7867-4	72
7872-24 ^(D)	120
7874MF-22	120
7874MF-25	120
7874MF-34	120
7874MF-40	120
7876-60 ^(D)	120
7876-80 ^(D)	120
7876-100 ^(D)	120
7876-120 ^(D)	120
7876-160 ^(D)	120
7881	2
7882	2
7896-1	2
7896-2	2
7896-3	2
7897	4
7898	4, 7
7899	4
7903-50-5 ^(D)	13

9

9511007	10
---------	----

A

AQ1728 ^(D)	42
-----------------------	----

CEV

CEV669BG	108
CEV984	9
CEV985	9

CP

CP16	50
CP16-1	50
CP17	22
CP17-1	22
CP17-2	22
CP17-3	22
CP21-3	24
CP21A-3	24
CP23-4	26
CP23-6	26
CP23-8	26
CP23-10	26
CP23A-8	26
CP37	62
CP291	39
CP300	31
CP301-1	38
CP301-2	39
CP301-3	39
CP301-4	40
CP301-5	40
CP301-9	40
CP301-10	40
CP302-2	29
CP302-3	29
CP302-4	29
CP302-5	29
CP302-6	29
CP302-8	29
CP304-2	33
CP304-3	33
CP304-4	33
CP304-5	33
CP304-6	33
CP304-7	33
CP304-8	33
CP304-9	33
CP304-10	33
CP304-11	33

CP304-12	33
CP304-14	33
CP304-15	33
CP304-16	33
CP304B-2	33
CP304B-3	33
CP304B-4	33
CP304B-5	33
CP304B-6	33
CP304B-8	33
CP304B-10	33
CP304B-12	33
CP305	34
CP305L	34
CP305R	34
CP306	26
CP309-8-12	35
CP309-10-14	35
CP309-12-16	35
CP309-14-16	35
CP309-14-18	35
CP310	21
CP310D	21
CP310E	21
CP313	36
CP313-1	36
CP314-14	35
CP315	34
CP315D	34
CP315G	34
CP316	34
CP317	33
CP318	33
CP330-3-0	76
CP330-4-0	76
CP331	25
CP331-1	25
CP332	62
CP333	19
CP335	24
CP337	17
CP337-1	17
CP338	25
CP339	25
CP340	25
CP341	25
CP344A	21
CP344AT	21
CP344B	21
CP344BT	21
CP344C	21
CP344CT	21
CP344D	21
CP344DT	21
CP344E	21

^(D) Distributed by Integra MicroFrance SAS (France) - For corresponding manufacturer part numbers, see table in annex

CP344ET.....	21	CP414.....	62	CP823-5.....	32
CP345.....	65	CP415.....	64	CP824-5.....	32
CP348.....	59	CP604.....	63	CP825.....	20
CP350.....	61	CP604-15.....	63	CP827.....	38
CP351-2.....	57	CP604BR.....	69	CP828.....	38
CP351-3.....	57	CP604M.....	70	CP904.....	38
CP351-6.....	57	CP605.....	63	CP905.....	38
CP351-7.....	57	CP605-15.....	63	CP905-1.....	38
CP352.....	58	CP605BR.....	69	CP907.....	31
CP352-1.....	58	CP605M.....	70	CP919.....	50
CP352-2.....	58	CP606.....	63	CP919A.....	50
CP352-3.....	58	CP606-15.....	63	CP921.....	55
CP353.....	50	CP606A.....	63	CP922.....	53
CP354.....	51	CP609.....	24	CP922A.....	53
CP354A.....	51	CP611.....	14	CP922B.....	54
CP355.....	52	CP612.....	59	CP931.....	57
CP355A.....	52	CP613.....	59	CP931-1.....	57
CP355C.....	55	CP614.....	59	CP933-14.....	64
CP356.....	50	CP615-1.....	61	CP933-16.....	65
CP358.....	50	CP615-2.....	61	CP933-18.....	67
CP358A.....	50	CP615-3.....	61	CP934.....	64
CP359.....	59	CP616-13.....	55	CP934-1.....	64
CP360.....	61	CP616-15.....	55	CP936.....	65
CP362.....	51	CP621.....	47	CP938-1.....	62
CP363.....	53	CP622-4.....	19	CP941.....	22
CP365.....	55	CP624-45.....	7	CP947.....	27
CP367.....	52	CP624-55.....	7	CP949-45.....	7
CP367-1.....	52	CP624-65.....	7	CP949-55.....	7
CP380.....	45	CP624-75.....	7	CP949-75.....	7
CP380-1.....	45	CP624LF-75.....	7	CP973.....	39
CP380-2.....	45	CP625.....	14	CP974.....	39
CP380-3.....	45	CP626.....	15	CP976.....	39
CP380-5.....	45	CP627.....	15	CP978.....	38
CP381.....	48	CP628.....	22	CP985.....	14
CP390-1.....	70	CP630.....	27	CP988-15.....	64
CP390-2.....	70	CP632.....	27	CP988-18.....	66
CP390-8.....	70	CP635.....	59	CP988-20.....	68
CP391E.....	70, 110	CP637.....	54	CP997.....	52
CP391M.....	70, 110	CP640.....	43	CP998-1.....	39
CP391V.....	70, 110	CP801-7.....	32	CP1100.....	39
CP392-1R.....	69	CP801-10.....	32	CP1102.....	17
CP392-2R.....	69	CP802.....	34	CP1103.....	17
CP392-8R.....	69	CP803.....	25	CP1104.....	40
CP392BI.....	69	CP806.....	36	CP1105.....	40
CP392BS.....	69	CP807.....	36	CP1106.....	59
CP393-2.....	69, 108, 109, 119	CP808-6.....	36	CP1107.....	71
CP393-3.....	69, 108, 109, 119	CP809.....	39	CP1109.....	42
CP393-4.....	69, 108, 109, 119	CP810.....	38		
CP400.....	64	CP814-1.....	43		
CP400-1.....	62	CP814-2.....	43		
CP400-2.....	67	CP814-3.....	43		
CP401.....	65	CP821.....	18		
CP406.....	62	CP822-10.....	22		
CP407.....	64	CP822-12.....	22		
CP409.....	66	CP822-14.....	22		

M

M832.....	63
M833.....	63

MCEN

MCEN2	7	MCEN53	94	MCEN82-W	82
MCEN3	90	MCEN54	108	MCEN83-C	82
MCEN4	90	MCEN54G	108	MCEN83O	82
MCEN4DG	88	MCEN54H	108	MCEN83OL	82
MCEN5	90	MCEN54I	108	MCEN83-S	82
MCEN5B	90	MCEN54P	108	MCEN83-W	82
MCEN5BDG	88	MCEN55	84	MCEN84S ^(D)	82
MCEN5DG	88	MCEN56	87	MCEN87C	82
MCEN10	16	MCEN56-1	87	MCEN87O3	82
MCEN11	110	MCEN61	87	MCEN87O4	82
MCEN12	104	MCEN62A1	89	MCEN87-S	82
MCEN18	11	MCEN62A1DG	88	MCEN87W	82
MCEN19	11	MCEN62A2	89	MCEN88SC	82
MCEN21	107	MCEN62A2DG	88	MCEN90	87
MCEN21R	107	MCEN62A3	89	MCEN90DG	88
MCEN23-2-5	78	MCEN62B1	89	MCEN91	87
MCEN23-3-0	78	MCEN62B1DG	88	MCEN91B	87
MCEN25-4-0	83	MCEN62B2	89	MCEN91BDG	88
MCEN27	98	MCEN62B2DG	88	MCEN91DG	88
MCEN27-1	98	MCEN62B3	89	MCEN96	94
MCEN27-2	99	MCEN62T1	89	MCEN97	94
MCEN27-3	99	MCEN62T1DG	88	MCEN98	104
MCEN27R	98	MCEN62T2	89	MCEN99	94
MCEN28	83	MCEN62T2DG	88	MCEN100-2-0	110
MCEN29	90	MCEN62T3	89	MCEN100-2-5	110
MCEN33	87	MCEN64	109	MCEN100-3-0	110
MCEN33DG	88	MCEN65	102	MCEN100-3-5	110
MCEN34	87	MCEN66	102	MCEN101	110
MCEN34DG	88	MCEN67	102	MCEN102	110
MCEN35	94	MCEN67-1	102	MCEN103	86
MCEN36	94	MCEN67-2	102	MCEN103LDG	79
MCEN37-1-20	79	MCEN68	95	MCEN104	28
MCEN37-1-25	79	MCEN68ADG	88	MCEN105	110
MCEN37-1-30	79	MCEN68BDG	88	MCEN106	28
MCEN37-2-0	79	MCEN68CDG	88	MCEN107	28
MCEN37-2-5	79	MCEN73	102	MCEN109	28
MCEN37-3-0	79	MCEN77-3-0	80	MCEN110	112
MCEN37-3-5	79	MCEN77-3-5	80	MCEN111	112
MCEN37D4	79	MCEN78J30	80	MCEN112	112
MCEN38	100	MCEN78J40	80	MCEN114	112
MCEN39	16	MCEN79J25	80	MCEN115-6	112
MCEN39L	88	MCEN79J30	80	MCEN115-8	112
MCEN41-1	106	MCEN79J40	80	MCEN115-9	112
MCEN41D3	106	MCEN80	82	MCEN116	112
MCEN41J	106	MCEN81-C	82	MCEN117	112
MCEN42	106	MCEN81O	82	MCEN118	112
MCEN42-1	106	MCEN81O1	82	MCEN120	112
MCEN42J	106	MCEN81O2	82	MCEN127	86
MCEN42J1	106	MCEN81-S	82	MCEN128	110
MCEN43	90	MCEN81-W	82	MCEN130	116
MCEN44	86	MCEN82-C	82	MCEN131	116
MCEN49	100	MCEN82O	82	MCEN133	116
MCEN50	86	MCEN82O5	82	MCEN134	116
		MCEN82O6	82	MCEN135	116
		MCEN82-S	82	MCEN136SC	116, 121

^(D) Distributed by Integra MicroFrance SAS (France) - For corresponding manufacturer part numbers, see table in annex

MCEN138.....	117
MCEN138S.....	117
MCEN139.....	117
MCEN139A.....	117
MCEN140.....	117
MCEN140A.....	117
MCEN141.....	117
MCEN141A.....	117
MCEN142.....	117
MCEN147.....	117
MCEN149W.....	116, 117
MCEN151.....	114
MCEN152.....	114
MCEN153.....	114
MCEN154.....	114
MCEN155.....	114
MCEN156.....	114
MCEN157.....	114
MCEN158.....	114
MCEN161.....	115
MCEN162.....	115
MCEN163.....	115
MCEN164.....	115
MCEN165.....	115
MCEN167.....	115
MCEN168.....	115
MCEN169.....	115
MCEN170.....	115
MCEN171.....	115
MCEN183.....	80
MCEN184.....	80
MCEN186.....	80
MCEN187.....	16
MCEN190.....	118
MCEN191.....	118
MCEN192.....	118
MCEN193.....	118
MCEN194.....	118
MCEN195.....	118
MCEN211.....	107
MCEN211S.....	107
MCEN212.....	107
MCEN212S.....	107
MCEN213.....	107
MCEN213S.....	107
MCEN214.....	117
MCEN215.....	117
MCEN216L.....	117
MCEN216R.....	117
MCEN217L.....	117
MCEN217R.....	117
MCEN217S.....	117
MCEN217U.....	117
MCEN218.....	118
MCEN328S.....	119

MCEN328U.....	119
MCEN329.....	119
MCEN330.....	119
MCEN344S.....	119
MCEN344U.....	119
MCEN344V.....	119
MCEN345.....	119
MCEN346.....	119
MCEN347.....	119
MCEN348.....	119
MCEN349.....	119
MCEN350.....	119
MCEN350H.....	89
MCEN350V.....	89
MCEN351.....	119
MCEN360H.....	89
MCEN360V.....	89
MCEN364.....	119
MCEN365.....	119
MCEN371D4.....	79
MCEN371D35.....	79
MCEN640.....	108, 109
MCEN641.....	109
MCEN643.....	109
MCEN644.....	109
MCEN713.....	85
MCEN720.....	113
MCEN721.....	113
MCEN723.....	113
MCEN728DG.....	88
MCEN730.....	110
MCEN760.....	113
MCEN761.....	113
MCEN762.....	113
MCEN763.....	113
MCEN764.....	16
MCEN765.....	16
MCEN766.....	80
MCEN767.....	80
MCEN768.....	113
MCEN769.....	113
MCEN770B25.....	79
MCEN770B30.....	79
MCEN770J30.....	76
MCEN770J40.....	76
MCEN960H.....	89

MCL

MCL38N.....	7
MCL75.....	7
MCL170 ^{(D)(i)}	7
MCL171 ^{(D)(i)}	7
MCL173 ^{(D)(i)}	7
MCL174 ^{(D)(i)}	7
MCL197 ^{(D)(i)}	7

MCLW

MCLW10.....	117
MCLW11.....	117

MCO

MCO1B.....	78
MCO201-2-5.....	76
MCO201-3-0.....	76
MCO214-13-10.....	32
MCO214-13-20.....	32
MCO214-13-40.....	32
MCO214-13-60.....	32
MCO214-13-80.....	32
MCO233.....	4
MCO237.....	4
MCO305.....	14
MCO311-1-0.....	78
MCO311-1-2.....	78
MCO311-1-5.....	78
MCO311-1-8.....	78
MCO311-2-0.....	78
MCO311-2-5.....	78
MCO311-3-0.....	78
MCO311-3-5.....	78
MCO311-4-0.....	78
MCO731 ^(D)	120
MCO770-1-5.....	76
MCO770-2-0.....	76
MCO770-2-5.....	76
MCO770-3-0.....	76
MCO770-3-5.....	76
MCO770-4-0.....	76
MCO771-2-5.....	76
MCO771-3-0.....	76
MCO771-4-0.....	76
MCO772.....	78
MCO775-1.....	78
MCO776.....	78
MCO803.....	14
MCO805.....	3
MCO805A.....	3
MCO807.....	3
MCO950.....	3

⁽ⁱ⁾ Not a medical device

^(D) Distributed by Integra MicroFrance SAS (France) - For corresponding manufacturer part numbers, see table in annex

MCO978	9
MCO978S	9
MCO979	20
MCO980	9
MCO981	9
MCO981D	9
MCO982	9
MCO983	9
MCO983-4	9
MCO988	20
MCO995	30

MCSK

MCSK1	111
MCSK2	111
MCSK3	111
MCSK4	111
MCSK5	111
MCSK6	111

P

P761-7	72
P761-8	72
P762-2	73
P762-4	73
P763	74
P764-1	73
P764-3	73
P764-5	73
P764-7	73
P764-11	73
P765-14	74
P765-16	74
P769	74

S

SCP337A	17
---------------	----

**Table for corresponding
manufacturer part numbers
For information purposes only**

Integra MicroFrance® product reference	Corresponding manufacturer part number
1003IG	M3IG
1003LI	M3LI
1004IG	M4IG
1005I	M5I
7746A	651
7746B	650
7771AS10	A 1908S
7776	76.51.20
7872-24	1224
7876-100	310
7876-120	312
7876-160	316
7876-60	306
7876-80	308
7903-50-5	13.202
AQ1728	PS-1728
MCEN84S	MCEN84S
MCL38N	EC-BLU50U090
MCL170 ⁽¹⁾	CO101
MCL171 ⁽¹⁾	CO201
MCL173 ⁽¹⁾	CO100
MCL174 ⁽¹⁾	CO200
MCL197 ⁽¹⁾	CO103
MCO731	430490

⁽¹⁾ Not a medical device



Global alphabetical index

A

Adapter	
<i>Adapter for endoscope</i>	7
<i>Adapter for fiberoptic</i>	7
<i>Adapter luer-lock</i>	88
<i>Luer-lock US adapter</i>	78
Adson	63, 69, 70
Adson-Brown	63
Adson-Tubiana	63
Aesculap	69, 70, 108, 109, 110, 119
Aiach	33
Air bag	2
Albertini	83
Allis	75
Angled probe caustic holder	3
Appelbaum	110
Aquaplast™	42
Aufricht	26, 39

B

Backauss	75
Ball probe	119
Ballenger	19, 32
Barraya	64, 65, 67
Bebee	61
Becker	36, 40, 48, 71
Becker-converse	59
Beckman	4, 5
Benezeth	78
Berchtold	69, 70, 108, 109, 110, 119
Beyer	45, 46
Bigot	39
Bipolar	
<i>Bipolar angled handle</i>	108
<i>Bipolar cable</i>	69, 108, 109, 119
<i>Bipolar forceps</i>	69, 119
<i>Bipolar forceps angled jaws</i>	108, 109
<i>Bipolar forceps bayonet jaws</i>	69, 119
<i>Bipolar forceps serrated jaws</i>	69
<i>Bipolar forceps smooth jaws</i>	69
<i>Bipolar forceps with suction</i>	109
<i>Bipolar insert spatula angled jaws</i>	108
<i>Bipolar insert triangle jaws</i>	108
<i>K handle bipolar connection</i>	108
<i>Non-insulated tube for bipolar instrument</i>	108

Blakesley	12, 92, 93, 101
Blunt probe angled	114
Boettcher	52
Bovie	70, 110
Bowa	69, 70, 108, 109, 110, 119
Bregeat	53
Brophy	52
Brünings	11

C

Cable	
<i>Bipolar cable</i>	69, 108, 109, 119
<i>Monopolar cable</i>	70, 110
Caliper	43
Caplan	48
Cartilage crushing press	43
Cartilage template	42
Castroviejo	43, 62
Causse	2
Chaput	75
Chisel	32, 36
Chouard	13
Citelli	44
Citelli-Frèche	104
Citelli-Peynègre	104
Clamps	118
Claoué	25, 34, 65
Clip applicator	107
Comeg	82
Conmed	70, 110
Converse	23, 25, 59
Cottle	7, 8, 15, 19, 23, 26, 36, 59, 60, 65
Cottle-Pech	59
Cotton carrier	3
Crile	73
Crile-Wood	71
Curette	
<i>Curette</i>	29, 88
<i>Curved curette</i>	28
<i>Double curette</i>	28
<i>Frontal Sinus curette</i>	29
<i>Malleable curette</i>	28, 111, 117
<i>Orbital suction curette</i>	115
<i>Spoon</i>	28
<i>Suction curette with finger control</i>	113

D

Dacryocystorhinostomy	86
Darrouzet	9
De Gabory	79, 88
Debakey	64, 66, 68
Desmarres	22
Dessi	82, 87, 106, 108
Devèze	9
Diagnostic device	2
Dingmann	15
Displacer	
<i>Displacer</i>	49
<i>Displacer elevator</i>	84
Double-ended probe	113
Drill with adjustable thrust	111
Dufourmental	27
Duncavage	114

E

Electric irrigation pump	82
<i>Electric irrigation pump</i>	82
<i>Irrigation tubing</i>	82
Electrode cautery	2
Elevator	
<i>Angled elevator</i>	86, 114
<i>Angled suction tube elevator</i>	114
<i>Curved elevator</i>	14
<i>Curved suction tube elevator</i>	16
<i>Displacer elevator</i>	84
<i>Double-ended elevator</i>	14, 15
<i>Elevator</i>	119
<i>Monopolar suction tube elevator</i>	110
<i>Orbital perforator elevator</i>	115
<i>Periosteal elevator</i>	15
<i>Septum elevator</i>	15
<i>Septum elevator suction tube</i>	17
<i>Suction tube elevator</i>	16, 17
<i>Zygoma elevator</i>	84
Emc	69, 108, 109, 119
Erbe	69, 70, 108, 109, 110, 119
Eustachian catheter probe	2

F

Farabeuf	20, 22
Ferguson-Frazier	77
Fiberoptic	7

Fleury	14, 20, 32
Fomon	39, 40, 41, 56, 59, 60
Forceps	
<i>Angled forceps serrated jaws</i>	11
<i>Angled forceps smooth jaws</i>	11
<i>Antrum cup forceps</i>	95
<i>Articulated punch forceps</i>	105
<i>Backbiting punch forceps</i>	98
<i>Bayonet bipolar forceps</i>	69
<i>Biopsy and grasping forceps</i>	96, 97
<i>Biopsy cup forceps double-action</i>	83
<i>Bipolar forceps</i>	69, 108, 109, 119
<i>Bipolar forceps with suction</i>	109
<i>Bipolar insert spatula angled jaws</i>	108
<i>Bipolar insert triangle jaws</i>	108
<i>Clean-bite forceps</i>	103
<i>Cleaning device for punch forceps</i>	112
<i>Columella dissecting forceps</i>	65
<i>Cup forceps</i>	88, 89, 90, 91, 94, 95, 97, 114, 119
<i>Cutting punch forceps</i>	103
<i>Delicate forceps serrated jaws</i>	63
<i>Disposable suction tip</i>	109
<i>Dissecting forceps</i>	10, 62, 63, 64, 65, 66, 67, 68
<i>Fenestrated cup forceps</i>	87, 88, 89, 92, 94
<i>Fenestrated spoon jaws forceps</i>	11
<i>Fixation forceps with lock</i>	65
<i>Forceps serrated jaws</i>	10, 11
<i>Forceps with teeth</i>	74, 75
<i>Giraffe forceps</i>	96, 103
<i>Haemostatic forceps</i>	72, 73, 74
<i>Horizontal thru-cutting forceps</i>	114
<i>Josephine punch cutting forceps</i>	100
<i>Maxillary biopsy cup forceps</i>	95
<i>Monopolar forceps</i>	70
<i>Nasal forceps</i>	12, 91
<i>Non-insulated tube for bipolar instrument</i>	108
<i>Orbital forceps</i>	115
<i>Packing dressing forceps bayonet style</i>	10
<i>Pear-shaped cupped jaw forceps</i>	96
<i>Pediatric backbiting punch forceps</i>	99
<i>Pediatric fenestrated cup forceps</i>	93
<i>Perforator bone forceps with teeth</i>	43

<i>Punch biopsy forceps curved</i>	97
<i>Punch cutting forceps</i>	102
<i>Punch rongeur</i>	44, 104, 105
<i>Septum fenestrated cup forceps</i>	12
<i>Septum forceps</i>	47
<i>Septum forceps serrated jaws</i>	12
<i>Skull base forceps curette jaws</i>	117
<i>Spoon jaws forceps</i>	10, 11
<i>Straight forceps</i>	49
<i>Straight punch cutting forceps</i>	102
<i>Thru-cutting forceps</i>	101
<i>Thru-flow suction cup forceps</i>	112
<i>Thru-flow suction fenestrated cup forceps</i>	87, 92
<i>Universal fenestrated cup forceps</i>	87
<i>Vertical cup forceps</i>	89, 90, 114
<i>Vertical Thru-cutting forceps</i>	114
Fox	50
Frazier	23, 77, 81
Frèche	28, 110
Freer	14, 15
Friedrich	86

G

Gayet	108
Gillies	22, 84
Giraffe	96, 103
Glabella	39
Gorney	17, 40, 48
Gouge	
<i>Bayonet gouge</i>	32
<i>Gouge</i>	32
<i>Osteotome gouge</i>	35
Graefe	65
Gruenwald	103
Guillen	17

H

Hajek-Kofler	104, 105
Halsey	71
Halsted	72
Halsted-Mosquito	72
Hand drill	111
Handles	
<i>Bipolar angled handle</i>	108
<i>Handle</i>	79
<i>K handle bipolar connection</i>	108
<i>Scalpel handle</i>	18

<i>Stylet handle</i>	88
<i>Universal Handle</i>	81
Hartmann	4
Hartmann-Mosquito	72
Heavy	20
Herman	86, 108, 110
Heuwieser	95
Heymann-Klossek	61
Hook	
<i>Blunt hook</i>	3
<i>Hook</i>	119
<i>Malleable blunt hook</i>	111
<i>Monopolar hook</i>	110
<i>Nerve hook blunt</i>	23
<i>Round sharp hook</i>	22
<i>Skin hook</i>	23, 26
Howarth	14
Humby	22

I

Insert	
<i>Bipolar insert spatula angled jaws</i>	108
<i>Bipolar insert triangle jaws</i>	108
Itard	2

J

Jankowski	28, 76, 80, 89, 106
Jansen-Middleton	47
Joseph	19, 21, 23, 26, 50, 52, 55
Jost	25, 32, 34, 43

K

Kelly	73
Kennedy	111
Kerrison	44
Kerrison-Costen	44
Killian	7, 8
Kilner	25
Kilner-jost	51
Kleinert-Kutz	23
Klossek	28, 87, 111
Knapp	24
Knight	60

Knife	
<i>Bayonet swivel knife</i>	19
<i>Button end angled knife</i>	19
<i>Diamond knife</i>	86
<i>Dissector and knife</i>	86
<i>Double knife</i>	113
<i>Electrode cautery</i>	2
<i>Knife and suction tube</i>	112
<i>Malleable sharp knife</i>	111
<i>Monopolar lancet knife</i>	110
<i>Nasal knife</i>	19
<i>Orbital knife</i>	115
<i>Push-pull anrostomy double knife</i>	113
<i>Sickle knife</i>	86, 115
Knot pusher	116
Kocher	73

L

Lamidey	69, 70, 108, 109, 110, 119
Legent	3, 9
Léger	55
Lemoine	111
Lempert	20, 46, 76
Lérault	86
Leriche	72
Levine	115
Lewis	12
Lima	28
Lindas	34
Lombard	30
Lubet-Barbon	11
Luc	11
Lucae	10
Lusk	102

M

Magnan	69
Malleable probe	111, 116, 117
Mallet	30, 31
Maltz	38
Marchac	33, 34
Marquet	3
Martel	74
Martin	49, 69, 70, 108, 109, 110, 119
Mayo	58
Mayo-Hegar	71

McIndoe	35, 64, 65
McKenty	15, 104
Metzenbaum	32, 57
Monopolar	
<i>Monopolar cable</i>	70, 110
<i>Monopolar electrod suction pick</i>	110
<i>Monopolar electrode pick</i>	110
<i>Monopolar forceps</i>	70
<i>Monopolar hook</i>	110
<i>Monopolar lancet knife</i>	110
<i>Monopolar suction tube elevator</i>	110
<i>Monopolar suction tube</i>	110
Morselizer	43
Mosquito	72

N

Nail	111
Nasal splint	42
Needle-holder	
<i>Needle-holder diamond jaws</i>	71
<i>Needle-holder tungsten jaws</i>	118
<i>Tungsten needle-holder</i>	71
Needle, injection needle	13
Neivert	37

O

Obwegeser	21
Obwegeser-Tessier	21
Offret	50
Olympus	7, 82
Operating room table clamp	9
Orbital loop	115
Orsel	16, 80, 95
Osteotome	
<i>Curved osteotome</i>	33, 37
<i>Graduated osteotome</i>	36
<i>Guarded osteotome</i>	34, 35, 36, 37
<i>Osteotome gouge</i>	35
<i>Straight osteotome</i>	33, 37

P

Palmer	2
Palmer-Piquet	2
Parkes	38
Parsons	113
Péan	74
Pech-Cannoni	38
Pech-Marchac	34

Pellegrini	59
Peynègre	94, 106
Peynègre-Bossard	94
Pick	
<i>Monopolar electrod suction pick</i>	110
<i>Monopolar electrode pick</i>	110
<i>Muschroom pick</i>	85
Plester	20
Politzer	10
Pollet-Pech	33
Potts-Smith	67
Pradès	11, 84
Précelle	65
Proetz	2
Punch rongeur	44, 104, 105

Punch

<i>Backbiting punch</i>	100
<i>Cutting circular punch</i>	100, 112
<i>Ostrum antrum punch backbiter</i>	98, 99
<i>Punch backbiter rotatable</i>	98
<i>Sidebiting antrum punch</i>	100
<i>Downbiting</i>	
<i>Sidebiting antrum punch</i>	100
Pushing syringe	13

R

Ragnell	27, 55
Raspatory	
<i>Curved double raspatory</i>	15
<i>Curved raspatory</i>	20, 21
<i>Straight raspatory</i>	21
Rasp	
<i>Coarse rasp</i>	38
<i>Concave rasp</i>	39
<i>Curved rasp</i>	39, 41
<i>Diamond surface rasp</i>	38, 39
<i>Double-ended rasp</i>	40, 41
<i>Downstroke rasp</i>	38
<i>Rasp cross-cutting</i>	39
<i>Rasp downcutting</i>	38
<i>Sure-Grip™ tungsten rasp</i>	40
<i>Tungsten rasp</i>	40, 41
Rees	40
Retractor	
<i>Articulated retractor</i>	22
<i>Blunt retractor</i>	22, 24, 25, 26, 27
<i>Double retractor blunt</i>	22, 24, 25, 27
<i>Lid retractor</i>	22

<i>Sharp retractor</i>	24, 25, 26
Reynolds	55
Robin	35
Rochester-Péan	73
Rongeur	
<i>Curved rongeur</i>	46
<i>Double-action bone rongeur</i>	48
<i>Double-action rongeur</i>	45, 47
<i>Straight rongeur</i>	46
Rouvier	7, 11, 16, 83, 86, 90, 100, 106, 110
Rubin	33, 43
Ruskin	48
Ryder	71

S

Scissors	
<i>Angled scissors pointed blades</i>	59
<i>Bone scissors serrated blades</i>	48
<i>Curved micro scissors</i>	106, 117
<i>Curved scissors beveled blades</i>	58
<i>Curved scissors blunt tip</i>	53, 54, 55, 57
<i>Curved scissors pointed blades</i>	50, 51, 52
<i>Curved Tenotomy scissors blunt tip</i>	53, 54
<i>Delicate curved scissors blunt tip</i>	57
<i>Delicate straight scissors blunt tip</i>	57
<i>Dissecting scissors</i>	56
<i>Dorsal scissors</i>	59, 60
<i>Dorsal scissors blunt tip</i>	59
<i>Dorsal scissors serrated blades</i>	59
<i>Dorsal scissors supercut™</i>	60
<i>Dural scissors</i>	60, 61
<i>Lower lateral scissors</i>	56, 59
<i>Nasal scissors curved</i>	55, 56
<i>Nasal Sinus scissors curved</i>	106
<i>Nasal Sinus scissors straight</i>	106
<i>Pediatric Sinus scissors curved</i>	106
<i>Pediatric Sinus scissors straight</i>	106
<i>Scissors bayonet</i>	119
<i>Septum scissors serrated blades</i>	48
<i>Straight micro scissors</i>	106, 117
<i>Straight scissors beveled blades</i>	58
<i>Straight scissors blunt tip</i>	57
<i>Straight scissors pointed blades</i>	50, 51, 52
<i>Straight scissors serrated blades</i>	61, 106
<i>Straight Tenotomy scissors</i>	53, 54
<i>Titanium scissors</i>	106
<i>Turbinate scissors</i>	48

<i>Up micro scissors</i>	117
<i>Wire cutting dural scissors</i>	61
Sébileau	14, 20
Seeker	85, 113
Senn-Miller	24
Shea	54
Silver	34
Sisson	23
Skinner	95
Sleeve for telescope	82
Smooth plate device	43
Speculum	
<i>Infant Nasal speculum</i>	6
<i>Nasal speculum</i>	5, 6
<i>Nasal speculum left hand</i>	5
<i>Screws speculum</i>	2
<i>Self-retaining Septum speculum</i>	8
<i>Self-retaining speculum</i>	4, 7, 8
<i>Self-retaining speculum with fiber optic</i>	7
<i>Septum speculum</i>	8
<i>Speculum</i>	4
<i>Speculum left hand</i>	4
<i>Spring speculum</i>	2
Stainless steel cup	120
Stamm	119
Sterilization case, tray	
<i>Plastic sterilization case</i>	116, 121
<i>Stainless steel sterilization case</i>	120
<i>Sterilization tray for bipolar forceps</i>	108, 109
Stevens	51, 53, 54
Stoll	43
Storz	7, 69, 70, 82, 108, 109, 110, 119
Streiff	50
Struempel	93
Struempel-Voss	87
Struycken	102
Suction irrigation tube	
<i>Irrigation tube</i>	83
<i>Irrigation tube guide</i>	83
<i>Suction irrigation tube</i>	76, 80, 81
Suction tube	
<i>Angled suction tube</i>	78
<i>Angled suction tube elevator</i>	114
<i>Bayonet suction tube elevator</i>	17

<i>Blunt malleable suction tube</i>	79, 116, 119
<i>Blunt suction irrigation tube</i>	80
<i>Blunt suction tube</i>	79, 80, 114
<i>Curved suction tube</i>	78
<i>Curved suction tube elevator</i>	16
<i>Knife and suction tube</i>	112
<i>Malleable suction tube</i>	111, 112, 116, 117
<i>Monopolar suction tube elevator</i>	110
<i>Monopolar suction tube</i>	110
<i>Septum elevator suction tube</i>	17
<i>Suction irrigation tube</i>	76, 81
<i>Suction tube adapter</i>	78
<i>Suction tube adapter rotatable</i>	78
<i>Suction tube angulated</i>	119
<i>Suction tube elevator</i>	16, 17
<i>Suction tube graduated</i>	77
<i>Suction tube long curve</i>	80
<i>Suction tube modelling lever</i>	116, 117
<i>Suction tube short curve</i>	80
<i>Suction tube with finger control</i>	76, 77
supercut™	60
Sure-Grip™	40, 41
Surgical instrument paraffin oil	120
Sutter	69, 70, 108, 109, 110, 119
Syringe	13
<i>Replacement tube for syringe</i>	13
<i>Silicon washer for syringe</i>	13
<i>Syringe</i>	13

T

Takahashi	91
Tension arm	9
<i>Articulated kneecap for arm</i>	9
<i>Ear quick-lock speculum for arm</i>	9
<i>Tension arm</i>	9
<i>Malleable blade for arm</i>	9
<i>Nasal speculum holder for arm</i>	9
<i>Self-retaining speculum for arm</i>	9
Terrier	74, 98, 99, 100
Tessier	34
Tieck	6
Tieck-Halle	4
Tightening key for crushing press	43
Toriumi	17, 39, 42, 121
Towel clamp	74, 75
Trocar and cannula	83

U

Universal tray	120
----------------	-----

V

Vacher	2
Valleylab	69, 70, 108, 109, 110, 119
Vaughan	112
Vienna	4, 5, 6
Volkmann	24, 29

W

Walsham	49
Watson-William	12
Weil	12
Weil-Blakesley	92, 101
Wertheimer	76
Wiener	41
Wolf	7, 69, 70, 82, 108, 109, 110, 119
Woo	117
Woodson	15
Wormald	107, 109, 116, 117, 118, 121

Alphabetical index
Search by name

A

Adson	Bipolar forceps	69
	Bipolar forceps serrated jaws	69
	Dissecting forceps	63
	Monopolar forceps	70
Adson-Brown	Dissecting forceps	63
Adson-Tubiana	Delicate forceps serrated jaws	63
	Dissecting forceps	63
Aesculap	Bipolar cable	69, 108, 109, 119
	Monopolar cable	70, 110
Aiach	Straight osteotome	33
Albertini	Irrigation tube	83
	Irrigation tube guide	83
	Trocar and cannula	83
Allis	Forceps with teeth	75
Appelbaum	Monopolar suction tube elevator with finger control	110
Aquaplast	Nasal splint	42
Aufricht	Blunt retractor	26
	Curved rasp	39

B

Backauss	Towel clamp	75
Ballenger	Bayonet swivel knife	19
	Gouge	32
Barraya	Dissecting forceps	64
Bebee	Wire cutting dural scissors	61
Becker	Needle-holder diamond jaws	71
	Septum scissors serrated blades	48
	Straight guarded osteotome	36
	Sure-Grip™ tungsten rasp	40
Becker-converse	Angled scissors pointed blades	59
Beckman	Nasal speculum left hand	5
	Speculum left hand	4
Benezeth	Suction tube adapter with finger control rotatable	78
Berchtold	Bipolar cable	69, 108, 109, 119
	Monopolar cable	70, 110
Beyer	Double-action rongeur	45
	Curved rongeur	46
Bigot	Rasp curved cross-cutting	39
Blakesley	Fenestrated cup forceps	92
	Pediatric fenestrated cup forceps	93
	Septum forceps serrated jaws	12
	Thru-cutting forceps	101
	Thru-cutting forceps angled	101
Boettcher	Curved scissors pointed blades	52

Bovie	Monopolar cable	70, 110
Bowa	Bipolar cable	69, 108, 109, 119
	Monopolar cable	70, 110
Bregat	Curved scissors blunt tip	53
Brophy	Curved scissors pointed blades	52
	Straight scissors pointed blades	52
Brünings	Fenestrated spoon jaws forceps	11
	Spoon jaws forceps	11

C

Caplan	Bone scissors serrated blades	48
Castroviejo	Caliper	43
	Dissecting forceps horizontal	62
	Dissecting forceps oblique	62
Causse	Air bag	2
Chaput	Forceps with teeth	75
Chouard	Pushing syringe	13
Citelli	Punch rongeur	44
Citelli-Frèche	Punch rongeur	104
Citelli-Peynègre	Punch rongeur	104
Claoué	Dissecting forceps	65
	Double retractor blunt	25
	Straight guarded osteotome	34
Comeg	Sleeve for telescope	82
Conmed	Monopolar cable	70, 110
Converse	Angled scissors pointed blades	59
	Blunt retractor	25
	Double retractor blunt	25
	Skin hook	23
Cottle	Blunt retractor	26
	Columella dissecting forceps	65
	Curved chisel	36
	Nasal knife	19
	Retractor	26
	Self-retaining Septum speculum	8
	Self-retaining speculum	7
	Septum elevator	15
	Skin hook	23
	Straight graduated osteotome	36
	Straight guarded osteotome	36
Cottle-Pech	Dorsal scissors	59
Crile	Haemostatic forceps	73
Crile-Wood	Tungsten needle-holder	71

D

Dacryocystorhinostomy	Diamond knife	86
	Sickle knife	86
Darrouzet	Self-retaining speculum for arm	9
De Gabory	Cup forceps	88
	Curette	88
	Fenestrated cup forceps	88
	Handle	79
	Stylet handle	88
Debakey	Dissecting forceps serrated jaws	64
Desmarres	Blunt retractor	22
	Lid retractor	22
Dessi	Bipolar angled handle	108
	Bipolar forceps angled jaws	108
	Bipolar insert spatula angled jaws	108
	Electric irrigation pump	82
	Irrigation tubing for pump	82
	Non-insulated tube for bipolar instrument	108
	Sleeve for telescope	82
	Straight scissors serrated blades	106
	Universal fenestrated cup forceps	87
Devèze	Self-retaining speculum for arm	9
Dingmann	Periosteal elevator	15
Dufourmental	Blunt retractor	27
Duncavage	Angled elevator	114
	Angled suction tube elevator	114
	Blunt probe angled	114
	Blunt suction tube	114
	Horizontal cup forceps	114
	Horizontal thru-cutting forceps	114
	Vertical cup forceps	114
	Vertical thru-cutting forceps	114

E

Emc	Bipolar cable	69, 108, 109, 119
Erbe	Bipolar cable	69, 108, 109, 119
	Monopolar cable	70, 110

F

Farabeuf	Curved raspatory	20
	Double retractor blunt	22
Ferguson-Frazier	Suction tube with finger control	77
Fleury	Curved elevator	14
	Curved raspatory	20
	Gouge	32

Fomon	Curved rasp	39
	Dissecting scissors	56
	Dorsal scissors blunt tip	59
	Dorsal scissors supercut™	60
	Double-ended rasp	40
	Lower lateral scissors	56
	Nasal scissors curved	56
Fox	Curved scissors pointed blades	50
	Straight scissors pointed blades	50
Frazier	Skin hook round sharp	23
	Suction irrigation tube	81
	Suction tube finger cutoff graduated	77
	Universal Handle	81
Frèche	Malleable curette	28
	Monopolar hook	110
	Monopolar lancet knife	110
	Monopolar suction tube with finger control	110
Freer	Double-ended elevator	14
Friedrich	Sickle knife	86

G

Gayet	K handle bipolar connection without ratchet	108
Gillies	Round sharp hook	22
	Zygoma elevator	84
Giraffe	Giraffe forceps	96
Glabella	Rasp	39
Gorney	Double-ended rasp	40
	Septum elevator suction tube	17
	Turbinates scissors serrated blades double action	48
Graefe	Fixation forceps with lock	65
Gruenwald	Clean-bite forceps	103
	Cutting punch forceps	103
Guillen	Bayonet suction tube elevator	17

H

Hajek-Kofler	Sphenoid punch rongeur	104
	Thru-cutting punch rongeur	105
Halsey	Tungsten needle-holder	71
	Tungsten needle-holder smooth jaws	71
Halsted	Haemostatic forceps	72
Halsted-Mosquito	Haemostatic forceps	72
Hartmann	Speculum	4
Hartmann-Mosquito	Haemostatic forceps	72
Heavy	Curved raspatory	20
Herman	Bipolar insert triangle fenestrated jaws	108
	Knife	86
	Monopolar hook	110
Heuwieser	Antrum cup forceps	95
Heymann-Klossek	Dural scissors	61
Howarth	Double-ended elevator	14
Humby	Sharp retractor articulated	22

I

Itard	Eustachian catheter probe	2
--------------	---------------------------	---

J

Jankowski	Cup forceps pear jaws	89
	Fenestrated cup forceps	89
	Horizontal cup forceps	89
	Malleable curette	28
	Suction tube long curve	80
	Suction tube short curve	80
	Suction tube with finger control	76
	Titanium left curved scissors serrated blades	106
	Titanium right curved scissors serrated blades	106
	Titanium straight scissors serrated blades	106
	Vertical cup forceps	89
Jansen-Middleton	Double-action rongeur	47
	Septum forceps	47

Joseph

Blunt retractor	26
Button end angled knife	19
Curved raspatory	21
Curved scissors blunt tip	55
Curved scissors pointed blades	50
Nasal knife	19
Sharp retractor	26
Skin hook	23
Straight raspatory	21
Straight scissors pointed blades	50

Jost

Cartilage crushing press	43
Double retractor blunt	25
Straight chisel	32
Straight guarded osteotome	34
Tightening key for crushing press	43

K

Kelly

Haemostatic forceps	73
---------------------	----

Kennedy

Malleable blunt hook	111
Malleable blunt probe	111
Malleable curette	111
Malleable sharp knife	111
Malleable suction tube	111

Kerrison

Punch rongeur	44
---------------	----

Kerrison-Costen

Punch rongeur	44
---------------	----

Killian

Self-retaining speculum	7
Self-retaining speculum with fiber optic	7
Septum speculum	8

Kilner

Blunt retractor	25
Sharp retractor	25

Kilner-jost

Curved scissors pointed blades	51
--------------------------------	----

Kleinert-Kutz

Skin hook	23
-----------	----

Klossek

Double curette	28
Fenestrated cup forceps	87
Nail	111
Spoon	28
Thru-flow suction fenestrated cup forceps	87

Knapp

Blunt retractor	24
Sharp retractor	24

Knight

Dural scissors	60
----------------	----

Kocher

Haemostatic forceps	73
---------------------	----

L

Lamidey	Bipolar cable	69, 108, 109, 119
	Monopolar cable	70, 110
Legent	Articulated kneecap for arm	9
	Blunt hook	3
	Ear quick-lock speculum for arm	9
	Tension arm	9
	Malleable blade for arm	9
	Nasal speculum holder for arm	9
Léger	Curved scissors blunt tip	55
Lemoine	Drill with adjustable thrust	111
	Hand drill	111
	Nail	111
Lempert	Curved raspatory	20
	Curved rongeur	46
	Straight rongeur	46
	Suction tube with finger control	76
Lérault	Angled elevator	86
Leriche	Haemostatic forceps	72
Levine	Orbital curved sickle knife	115
	Orbital double-ended perforator elevator	115
	Orbital forceps	115
	Orbital knife	115
	Orbital loop	115
	Orbital suction curette with finger control	115
Lewis	Septum fenestrated cup forceps	12
Lima	Curved curette	28
Lindas	Guarded osteotome	34
Lombard	Square mallet	30
Lubet-Barbon	Angled forceps serrated jaws	11
	Angled forceps smooth jaws	11
Luc	Fenestrated spoon jaws forceps	11
	Spoon jaws forceps	11
Lucae	Dissecting forceps	10
	Forceps serrated jaws	10
	Spoon jaws forceps	10
Lusk	Punch cutting forceps	102

M

Magnan	Bayonet bipolar forceps	69
Maltz	Downstroke rasp	38
Marchac	Curved osteotome	33
	Straight guarded osteotome	34
	Straight osteotome	33
Marquet	Blunt hook	3

Martel	Forceps with teeth	74
Martin	Bipolar cable	69, 108, 109, 119
	Displacer	49
	Monopolar cable	70, 110
Mayo	Curved scissors beveled blades	58
	Straight scissors beveled blades	58
Mayo-Hegar	Tungsten needle-holder	71
McIndoe	Dissecting forceps	65
	Dissecting forceps oblique	64
	Dissecting forceps serrated jaws	64
	Osteotome gouge	35
McKenty	Curved double raspatory	15
	Sphenoid punch rongeur	104
Metzenbaum	Curved scissors blunt tip	57
	Delicate curved scissors blunt tip	57
	Delicate straight scissors blunt tip	57
	Gouge	32
	Straight scissors blunt tip	57
Mosquito	Haemostatic forceps	72

N

Neivert	Osteotome single guarded	37
----------------	--------------------------	----

O

Obwegeser	Curved raspatory	21
	Very curved raspatory	21
Obwegeser-Tessier	Sharp curved raspatory	21
	Sharp very curved raspatory	21
Offret	Straight scissors pointed blades	50
Olympus	Adapter for fiberoptic	7
	Sleeve for telescope	82
Orsel	Blunt suction irrigation tube curved	80
	Blunt suction irrigation tube straight	80
	Cup forceps	95
	Curved suction tube elevator	16
	Suction tube elevator	16

P

Palmer	Spring speculum	2
Palmer-Piquet	Spring speculum	2
Parkes	Downstroke rasp	38
Parsons	Double knife	113
	Double-ended seeker	113
Péan	Haemostatic forceps	74
Pech-Cannoni	Coarse rasp	38
Pech-Marchac	Guarded osteotome curved left	34
Pellegrini	Dorsal scissors serrated blades	59

Peynègre	Fenestrated cup forceps	94
	Straight micro scissors serrated blades	106
Peynègre-Bossard	Fenestrated cup forceps	94
Plester	Curved raspatory	20
Politzer	Dissecting forceps	10
	Dissecting forceps serrated jaws	10
	Dissecting forceps spoon jaws angled	10
Pollet-Pech	Straight osteotome	33
Potts-Smith	Dissecting forceps	67
Pradès	Displacer elevator	84
	Forceps serrated jaws	11
Précelle	Dissecting forceps serrated angled jaws	65
Proetz	Diagnostic device	2

R

Ragnell	Double retractor blunt	27
	Nasal scissors curved flat dissection tips	55
	Nasal scissors curved flat dissection tips	55
Rees	Double-ended rasp	40
Reynolds	Curved scissors blunt tip	55
Robin	Double guarded osteotome	35
Rochester-Péan	Haemostatic forceps	73
Rouvier	Backbiting punch	100
	Cup forceps	90
	Dissector and knife	86
	Forceps serrated jaws	11
	Left curved micro scissors	106
	Malleable suction tube elevator	16
	Monopolar electro suction pick	110
	Monopolar electrode pick	110
	Right curved micro scissors serrated blades	106
	Self-retaining speculum serrated blades	7
	Trocar and cannula	83
Vertical cup forceps	90	
Rubin	Septum morselizer	43
	Straight osteotome	33
Ruskin	Double-action bone rongeur	48
Ryder	Tungsten needle-holder	71

S

Sébileau	Curved elevator	14
	Curved raspatory	20
Senn-Miller	Double retractor blunt	24
Shea	Curved scissors blunt tip	54
Silver	Guarded osteotome curved left	34
	Guarded osteotome curved right	34
	Straight guarded osteotome	34
Sisson	Nerve hook blunt	23
Skinner	Maxillary biopsy cup forceps	95
Stamm	Ball probe	119
	Bipolar forceps	119
	Bipolar forceps bayonet jaws straight	119
	Blunt malleable suction tube	119
	Cup forceps	119
	Elevator	119
	Hook	119
	Scissors bayonet	119
	Scissors bayonet straight	119
	Scissors bayonet vertical	119
	Suction tube angulated	119
Stevens	Curved scissors pointed blades	51
	Curved Tenotomy scissors blunt tip	53
	Straight Tenotomy scissors blunt tip	53
Stoll	Perforator bone forceps with teeth	43
Storz	Adapter for endoscope	7
	Adapter for fiberoptic	7
	Bipolar cable	69, 108, 109, 119
	Monopolar cable	70, 110
Sleeve for telescope	82	
Streiff	Curved scissors pointed blades	50
	Straight scissors pointed blades	50
Struempel	Pediatric fenestrated cup forceps	93
Struempel-Voss	Fenestrated cup forceps	87
Struycken	Punch cutting forceps, 45deg upturned	102
	Punch cutting forceps, 90deg upturned	102
	Straight punch cutting forceps	102
supercut™	Dorsal scissors supercut™	60
Sure-Grip™	Tungsten rasp coarse	40
Sure-Grip™	Tungsten rasp fine	41
Sutter	Bipolar cable	69, 108, 109, 119
	Monopolar cable	70, 110

T

Takahashi	Cup forceps	91
	Nasal cup forceps	91
	Nasal forceps	91
	Nasal suction forceps	91
Terrier	Adult backbiting punch forceps	98
	Haemostatic forceps	74
	Josephine punch cutting forceps left	100
	Pediatric backbiting punch forceps	99
Tessier	Straight guarded osteotome	34
Tieck	Infant Nasal speculum	6
Tieck-Halle	Speculum	4
Toriumi	Cartilage template	42
	Curved rasp	39
	Sterilization case	121
	Suction tube elevator dull with finger control	17
	Suction tube elevator sharp with finger control	17

V

Vacher	Screws speculum	2
Valleylab	Bipolar cable	69, 108, 109, 119
	Monopolar cable	70, 110
Vaughan	Cleaning device for punch forceps	112
	Cutting circular punch	112
	Knife and suction tube with finger control	112
	Malleable suction tube with finger control	112
	Thru-flow suction cup forceps	112
Vienna	Nasal speculum	5
	Speculum	4
Volkman	Curette	29
	Sharp retractor	24

W

Walsham	Straight forceps	49
Watson-William	Nasal polyp forceps	12
Weil	Nasal forceps	12
Weil-Blakesley	Fenestrated cup forceps	92
	Thru-cutting forceps 45deg serrated jaws	101
	Thru-cutting forceps left serrated jaws	101
	Thru-cutting forceps right serrated jaws	101
	Thru-cutting forceps serrated jaws	101
	Thru-flow suction fenestrated cup forceps	92

Wertheimer	Suction tube with finger control	76
Wiener	Antrum rasp curved	41
Wolf	Adapter for fiberoptic	7
	Bipolar cable	69, 108, 109, 119
	Monopolar cable	70, 110
	Sleeve for telescope	82
Woo	Straight micro scissors	117
	Up micro scissors	117
Woodson	Double-ended elevator	15
Wormald	Bipolar forceps angled jaws	109
	Bipolar forceps with suction straight	109
	Blunt malleable suction tube	116
	Clip applicator	107
	Debakey clamp	118
	Disposable suction tip	109
	Frontal sinus sterilization case	116, 121
	Knot pusher	116
	Left curved micro scissors	117
	Malleable basket suction tube	117
	Malleable blunt suction tube	116
	Malleable probe double-ended	116
	Malleable skull base probe	117
	Malleable suction curette with finger control	117
Malleable suction tube	116	
Needle-holder tungsten jaws	118	
Right curved micro scissors	117	
Skull base forceps curette jaws	117	
Straight micro scissors	117	
Suction tube modelling lever	116, 117	
Up micro scissors	117	

Integra® MicroFrance®

Integra ENT - Nose catalogue

Manufacturers :



Integra MicroFrance SAS (France)
Le Pavillon ■ 03160 Saint Aubin le Monial ■ France



Integra York PA, Inc
589 Davies Drive
York, PA 17402 ■ USA



Integra LifeSciences Sciences (France) SAS
Immeuble Séquoia 2 ■ 97 Allée Alexandre Borodine
Parc Technologique de la Porte des Alpes
69800 Saint Priest ■ France
Tél. : +33 (0)4 37 47 59 00 ■ Fax : +33 (0)4 37 47 59 30



HEMODIA SAS
85, rue du Chêne Vert
31670 LABEGE ■ France



Marquat Génie Biomédical
P.A. de la Haie Griselle
9 rue du 8 mai 1945 ■ B.P. 90011
94471 Boissy-St-Léger ■ France



Unimed SA
Rue du Grand-Pré 10
1007 Lausanne ■ Suisse



Swann Morton Ltd
Penn Works ■ Owlerton Green ■ Sheffield
South Yorkshire S6 2BJ ■ Royaume Uni

Manufacturers with CE Class I products only :



Agencinox
Zone Industrielle
89110 Aillant sur Tholon ■ France



Concorde Import Export
B.P. 37
92300 Levallois-Perret ■ France



Chemische Fabrik Dr. Weigert GmbH & Co.
Mühlenhagen
D-20539 Hamburg ■ Allemagne



Medicon eG
Gaensaecker 15
D-78832 Tuttlingen ■ Allemagne



Qfix
440 Church Road
Avondale ■ PA 19311 USA



Medical device & QA Services Ltd
76, Stockport Road ■ Timperley
Cheshire ■ WA15 75N ■ Royaume Uni



Sunoptic Technologies®, LLC
6018 Bowdendale Avenue
Jacksonville ■ FL 32216 USA



RMS - UK Limited
28 Trinity Road ■ Nailsea
Somerset ■ BS48 4NU ■ Royaume Uni

Availability of these products might vary from a given country or region to another, as a result of specific local regulatory approval or clearance requirements for sale in such country or region.

- Consult product labels and inserts for any indications, contraindications, hazards, warnings, precautions, and instructions for use.
- Non contractual document. The manufacturer reserves the right, without prior notice, to modify the products in order to improve their quality.
- Warning: Applicable laws restrict these products to sale by or on the order of a physician.

Additional information for EMEA Customers only :

Products mentioned in this document are CE class I, Im, IIa or IIb devices. Contact Integra should you need any additional information on devices classification. All the medical devices mentioned on this document are CE marked according to European council directive 93/42/EEC on medical devices and its relatives. References that are not medical devices are identified with the indication "NOT A MEDICAL DEVICE".

Products marked with the symbol ^(®) are distributed by Integra MicroFrance SAS (France)

Date of last révision : 12/2017

For more information, please contact customer service :

Europe, Middle-East, Africa

International : +33 (0) 437 47 59 50 ■ +33 (0) 437 47 59 25 (Fax) ■ csemea@integralife.com
France : +33 (0) 437 47 59 10 ■ +33 (0) 437 47 59 29 (Fax) ■ custsvcfrence@integralife.com
United Kingdom : +44 (0) 1264 345 780 ■ +44 (0) 1264 363 782 (Fax) ■ custsvcs.uk@integralife.com
Germany : +49 (0) 2102 5535 6200 ■ +49 (0) 2102 5536 636 (Fax) ■ custsvcgermany@integralife.com
Benelux : +32 (0)2 257 4130 ■ +32 (0)2 253 2466 (Fax) ■ custsvcbenelux@integralife.com
Italy : +39 (0)2 577 8921 ■ +39 (0)2 575 113 71 (Fax) ■ custsvcitaly@integralife.com
integralife.eu/contact

Integra and the Integra logo are registered trademarks of Integra LifeSciences Corporation or its subsidiaries in the United States and/or other countries.

MicroFrance is a trademark of Integra LifeSciences Corporation or its subsidiaries.
All other trademarks and product names are the property of their respective owners.

©2017 Integra LifeSciences Corporation. All rights reserved.

0332452-2-EN

DOCUMENT FOR USE IN EUROPE, MIDDLE-EAST AND AFRICA ONLY.