



Integra[®] MicroFrance[®]
Integra ENT - Throat catalogue

Table of contents	ii	Tonsil snare, Amygdalotome	17
Ordering and warranty informations	vi	Amygdalotome, tonsil blade	17
Indications / Contraindications	vii	Amygdalotome, handle	17
Diagnosis	2	Tonsil snare	17
Tongue depressor	2	Snare wire	17
Kilner mouth-gag	3	Stainless steel wire	17
Davis-Boyle mouth-gag	4	Other Tonsil adenoid instruments	18
April mouth-gag	5	Adenoid punch	18
Mouth-gag, complete	6	Tonsil snare	18
Morinière mouth-gag	7 - 9	Snare wire	18
Presentation	7	Neck surgery	19
Composition of the mouth-gag	8	Facial nerve dissector	19
Add-ins	9	Tracheal dilator	19
Tongue depressor	10	Curved dissector	19
Tongue depressor with suction tube and basket	10	Shear	19
Tongue depressor with basket	10	Tracheal retractor	19
Tonsil adenoid forceps	11 - 12	Grooved director	19
Tonsil forceps with teeth	11	Curved scissors	19
Tonsil haemostatic forceps	11	Micro surgery	20 - 21
Adenoid forceps	11	Micro irrigation tube	20
with open jaws	12	Micro vascular clamp	20
with serrated jaws	12	Micro dissecting forceps	20
with teeth, open ring	12	Jeweler forceps	20
without teeth, open ring	12	Approximator	20
Tonsil adenoid instruments	13 - 14	Needle-holder	21
Scalpel handle	13	Micro scissors	21
Tonsil knife	13	Container	21
Blunt curette	13	Silicone cover	21
Curved elevator	13	Suction tube with finger control	22
Double-ended elevator	13	Micro suction irrigation tube	22
Suction tube with finger control	13	Jankowski	22
Elevator and dissector	13	Lempert	22
Monopolar elevator suction tube	13	Wertheimer	22
Monopolar electrode pick	13	Elevator - Raspatory	23
Monopolar cable	13	Scalpel handle	24
Tonsil knife	14	Curved raspatory	25
Curved elevator	14	Other raspatory	26
Blunt suction tube	14	Sharp raspatory	26
Adenoid curette	15 - 16	Curved raspatory	26
with basket	15	Straight raspatory	26
without basket	15	Retractor	27 - 28
Sterile, Single use	16	Sharp hook	27
Adenotome	16	Double retractor	27
		Blunt retractor	27
		Sharp retractor, articulated	27
		Retractor with prongs	28

Large self-retaining retractor	29	Fine haemostatic forceps	53
Articulated self-retaining retractor	30	Medium haemostatic forceps	54
Malleable blade retractor - Double retractor	31	Strong haemostatic forceps	55
Blunt retractor - Double retractor	32	Towel clamp	55
Small scissors, pointed, matt finish	33	With teeth, "T" tip	55
Long scissors, pointed	34	with serrated jaws	55
Small scissors, blunt, matt finish	35	Forceps with teeth, Towel clamp	56
Long curved scissors, blunt	36	Other haemostatic forceps	57
Small Metzenbaum scissors, matt finish	37	with straight jaws	57
Large Metzenbaum scissors	38	with teeth	57
Mayo scissors, matt finish	39	with heart serrated jaws	57
Fine dissecting forceps	40	Esophagoscope	58
with teeth and platform	40	Esophagoscope	58
with serrated jaws	40	Fiber	58
with teeth	40	Handle	58
Adson dissecting forceps	41	Suction tube	58
Medium dissecting forceps	42 - 43	Forceps	58
with serrated jaws	42	Sterilization case	58
with teeth	42	Hypopharyngoscope	59
with teeth and platform	42	Hypopharyngoscope	59
Columella dissecting forceps	43	Fiber	59
Fixation forceps with lock	43	Suction tube	59
with serrated jaws	43	Forceps	59
with teeth	43	Diverticuloscope	60
Dissecting forceps, 180mm	44	Diverticuloscope	60
Dissecting forceps, 200mm	45	Suction tube	60
Medium bipolar dissection forceps	46	Fiber	60
Bipolar dissecting forceps, 200mm	47	Laryngoscope holder, Cold Light	61
Irrigation bipolar forceps	48	Laryngoscope holder	61
Medium monopolar dissecting forceps	49	Plate for Chest holder	61
Adson	49	Mustard Table	61
with smooth jaws	49	Operating table clamp	61
with serrated jaws	49	Cold light cable	61
with teeth	49	Adapter for cold light cable	61
Monopolar cable	49	Open laryngoscope	62
Large monopolar dissecting forceps	50	Laryngoscope without suction tube	63
Needle-holder, tungsten jaws	51	Laryngoscope with suction tube	64
Large tungsten needle-holder	52	Sataloff laryngoscope	65
		Micro suction tube	66
		Suction tube	66
		Blunt eyes suction tube	66
		Insulated suction tube with finger control	66
		Suction tube with finger control	66
		Sataloff suction tube	66

Bouchayer Instruments	67	Micro injection	74
Forceps, serrated jaws	67	Oro-tracheal injector	74
Heart-shaped forceps	67	Casiano transcervical laryngeal injection	74
Cup forceps	67	Pistol for injection	74
Bouchayer Instruments, Working length 220mm	68	Luer-lock adapter	74
Micro laryngeal scissors	68	Injection needle	74
Sickle knife	68	Sataloff instruments	75 - 76
Lancet knife	68	Injection needle	75
Lancet knife, handle and 3 blades	68	Micro knife	75
Micro laryngeal elevator	68	Micro sterile sickle knife	75
Micro retractor forceps	68	Micro blunt hook	75
Needle-holder	68	Micro curette for cyst	75
Pérouse Instruments, Working length 220mm	69	Micro spatula	75
Sterile disposable blade spear	69	Micro hook	75
Blade holder	69	Micro thyroplasty elevator	75
Micro laryngeal elevator	69	Mirror	75
Stylet handle	69	Micro ball dissector	75
Tungsten needle-holder insert	69	Instrument holder	75
Abitbol Instruments	70	Cotton carrier	75
Insulated suction tube with finger control	70	Cup forceps	76
Monopolar forceps with suction	70	Heart-shaped grasper	76
Monopolar cable	70	Alligator forceps	76
Other laryngeal instruments	71	Plastic sterilization case	76
Scalpel handle	71	Sataloff indirect Laryngeal instruments	77
Knife blade	71	Injection needle	77
Stylet handle	71	Laryngeal dilator	77
Tungsten needle-holder insert	71	Micro suction tube	77
Adapter for cleaning insert	71	Micro knife	77
Needle-Holder, tungsten jaws	71	Micro scissors	77
Sickle knife	71	Micro vascular knife	77
Knife	71	Micro forceps	77
Hook	71	Instrument holder	77
Retractor	71	Stainless steel sterilization case	77
Knife blade, sterile, disposable	72	Benninger instruments	78
Knife	72	Scissors	78
Micro scissors	72	Cup forceps	78
Laryngeal sprinkler	72	Heart-shaped grasper	78
Injection needle	72	Needle-holder	78
Double probe	72	Knot pusher	78
Micro coagulation	73	Plastic sterilization case	78
Monopolar suction tube with finger control	73	Kleinsasser instruments	79
Monopolar electrode pick	73	Micro scissors	79
Monopolar cable	73	Cup forceps	79
Bipolar forceps	73	Forceps, serrated jaws	79
Bipolar cable	73	Jako instruments	80
		Micro scissors	80
		Cup forceps	80
		Forceps, serrated jaws	80

Henry set - 3.0mm	81
Scissors	81
Monopolar hook	81
Palpation probe	81
Forceps, fenestrated jaws	81
Forceps, alligator serrated jaws	81
Trocar	81
Trocar holder ring	81
Terris thyroidectomy Instrument Set - Robotic thyroid surgery	82
Double retractor	82
Curved elevator	82
Peanut holder	82
Malleable suction tube elevator	82
Robotic thyroid surgery	82
Mini invasive instrumentation Ø 3.5mm	83
Metallic trocar with silicone valve	83
Metallic trocar with magnetic valve	83
Pediatric Instrumentation Ø 3.5mm	84
Composite trocar with silicone valve	84
Suction irrigation tube	85
Retractable knife	85
Monopolar hook	85
Bipolar forceps	86
2-piece : Insert Jaws with insulated tube	87
Cleaning adapter	87
Angled handle	88
Axial handle	89
Ergonomic handle	90
Scissors, 1-piece	91
Forceps, 1-piece	91
De Lagausie instruments	92
Needle-holder	92
Stainless steel cup, Tray, Surgical oil	93
Stainless steel sterilization case	94
Plastic sterilization case	95
Large plastic sterilization case	96
Numerical index	97
Table for corresponding manufacturer part numbers For information purposes only	105
Global alphabetical index	107
Alphabetical index Search by name	115

Pricing :

Prices stated in specific written quotations are firm for thirty days from the date given, and are otherwise subject to change without prior notice. Pricing terms stated on written agreements are governed by such agreements.

Minimum Order Requirements :

The minimum ordering amount is €250 (Integra reserves the right to apply €20 handling fees and transport fees for any order below €250). For partial unit orders, please contact the customer service to obtain a quote.

Administrative fees :

Administrative fees may be charged for any order.

Ordering Procedure :

A written purchase order is required for the purchase of Integra MicroFrance® products.

Acceptance of Orders :

Orders are accepted upon approval by Integra Customer Service.

Return Policy :

- Authorization from Customer Service must be obtained prior to returning product.
- Sterile product must be returned in unopened, undamaged cartons, packed to prevent damage.
- Non-sterile product must be returned in unused saleable condition in original package.
- No credit will be issued for special orders.
- A credit note will be issued for products returned less than ninety days from shipment date with a 20% restocking fee, provided that the product being returned is not damaged and it is possible to verify that the product has not been used or opened.

Integra Limited Warranty

Please refer to the warranty included in the packaging of each product to know the applicable warranty.

Contacts Customer service :

International

+33 (0) 4 37 47 59 50
 +33 (0) 4 37 47 59 25 (fax)
 csemea@integralife.com

France

+33 (0) 4 37 47 59 10
 +33 (0) 4 37 47 59 29 (Fax)
 custsvcfrence@integralife.com

Benelux

+32 (0) 2 257 4130
 +32 (0) 2 253 2466 (Fax)
 custsvcbenelux@integralife.com

United Kingdom

+44 (0) 1264 345 780
 +44 (0) 1264 363 782 (Fax)
 custsvcuk@integralife.com

Germany

+49 (0) 2102 5535 6200
 +49 (0) 2102 5536 636 (Fax)
 custsvcgermany@integralife.com

Italy

+39 (0) 2 577 8921
 +39 (0) 2 575 113 71 (Fax)
 custsvcitaly@integralife.com

MicroFrance® ENT Instrumentation

INDICATIONS

- All the medical devices showed in this catalogue have indications for diagnosis and/or ENT surgery.
- Sizes are not contractual and are given for information purposes only.

CONTRAINDICATIONS

- Do not use in indications other than the indications mentioned in the DFU or Labeling.

How to read the catalogue

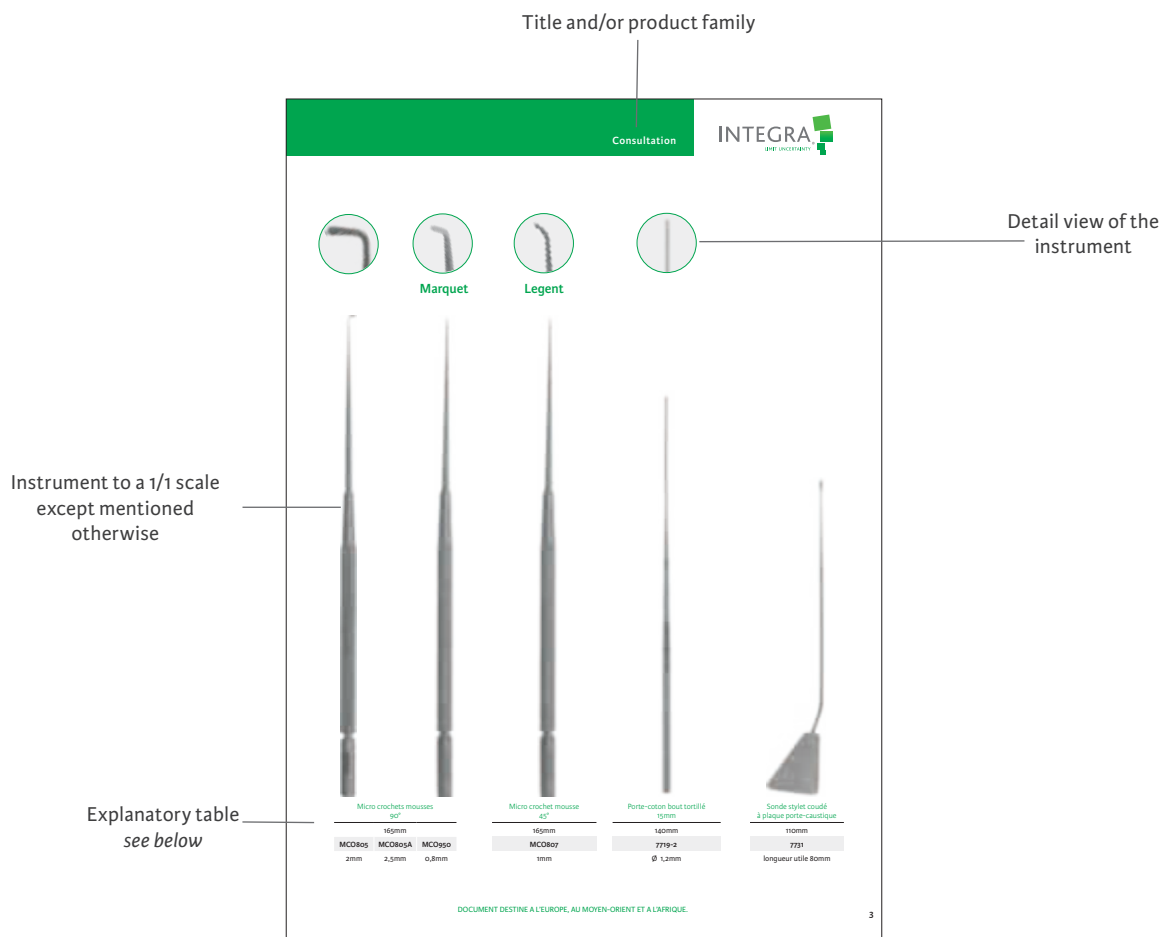

Explanation of the table reference and complementary product description

Title or subtitles	
Global complementary description	
Product ref.1	complementary description 1
Product ref.2	complementary description 2

Tongue depressor

Doyen



Double
150mm - Pack 10
7798T^(D)

Doyen



Double
150mm - Pack 10
7798T1^(D)

Canuyt



Fenestrated
185mm
7796

^(D) Distributed by Integra MicroFrance SAS (France) - For corresponding manufacturer part numbers, see table in annex

Scale 2/3



Kilner

Ring blade

7803S-3	7803S-2	7803S-1
40x75mm n°3	35x70mm n°2	30x60mm n°1



Kilner

Frame

7803C



Palatine blade

7803B

without fixing upper jaw



Camo® dental mouth guard

7960T40^(D)

Pack 40 - Single use



Chabolle

Ring blade

MCR3A	MCR2A
40x90mm n°3	40x80mm n°2



Silicone dental mouth guard

7802P

Pack 2

^(D) Distributed by Integra MicroFrance SAS (France) - For corresponding manufacturer part numbers, see table in annex



Davis-Boyle

Frame
7802C



Camo® dental mouth guard
7960T40^(D)
Pack 40 - Single use



Silicone dental mouth guard
7802P
Pack 2



Davis-Boyle

Blade with suction tube

7802S-5	7802S-4	7802S-3	7802S-2	7802S-1
20x105mm n°5	25x90mm n°4	25x75mm n°3	25x60mm n°2	20x25mm n°1

^(D)Distributed by Integra MicroFrance SAS (France) - For corresponding manufacturer part numbers, see table in annex

Scale 2/3



Designed for the use of handpieces



April

Frame

MCL201

right

April

Frame

MCL200

left



Camo[®] dental mouth guard

7960T40^(D)

Pack 40 - Single use



Silicone dental mouth guard

7802P

Pack 2

^(D) Distributed by Integra MicroFrance SAS (France) - For corresponding manufacturer part numbers, see table in annex

Scale 1/2

Masson

7809MF

140mm



Doyen

7821B

120mm

7821A

140mm



7821B



7805-11

Seemann-Seiffert

7805-11

110mm

7805-13

130mm

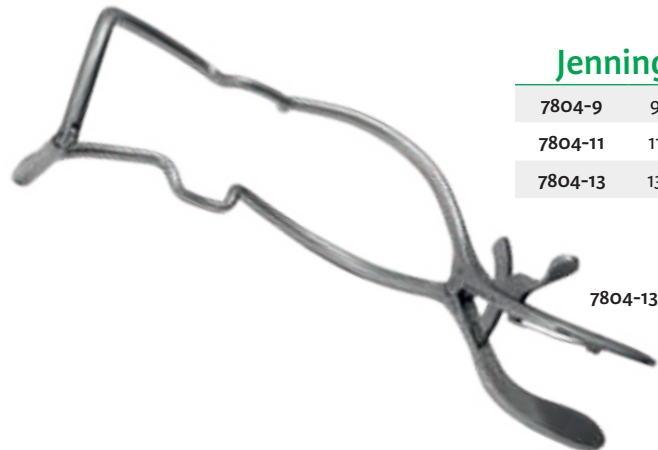

7804-13

Jennings

7804-9

90mm

7804-11

110mm

7804-13

130mm

Presentation of Morinière mouth-gag for mini invasive surgery

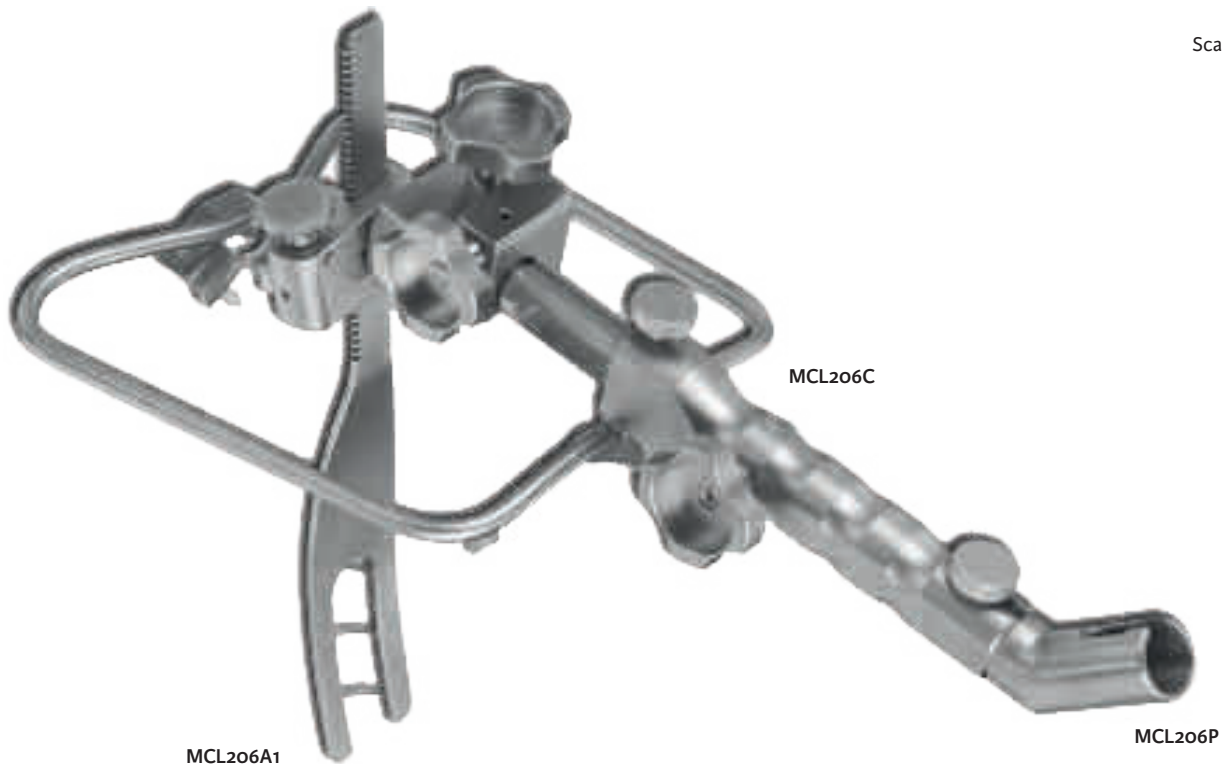

Scale 1/2

MCL206A1

MCL206C

MCL206P

Frame MCL206C
with ring blade MCL206A1
and adapter MCL206P

Composition of the mouth-gag

Scale 1/3

MCL206

Mouth-gag, mini invasive surgery, complete with 1 frame, 5 blades, 1 locking key and 1 angled intermediate piece.

Frame



MCL206C

Blade

MCL206A1 35x120mm ring blade



MCL206A2 35x120mm



MCL206A3 35x110mm



MCL206A4 40x85mm



MCL206A5 35x65mm



Locking key

Angled intermediate piece

MCL206K



MCL206P



Additional accessories, not included in ref. MCL206

MCL206A6 larynx blade 140x20mm



MCL206A7 Zenker's diverticulum blade 180x23mm



Add-ins instruments

Picture for information, without scale

Dental mouth guard

7802P Silicone dental mouth guard (Pk 2)

7960T40^(D) Camo® dental mouth guard Single use - (Pk 40)



Fiberoptic

MCL38N^(D) Fiberoptic, 2200mm without adapter

Adapters

MCL170^{(D)(1)} **Wolf**

MCL171^{(D)(1)}

MCL173^{(D)(1)} **Storz**

MCL174^{(D)(1)}

MCL197^{(D)(1)} **Olympus**

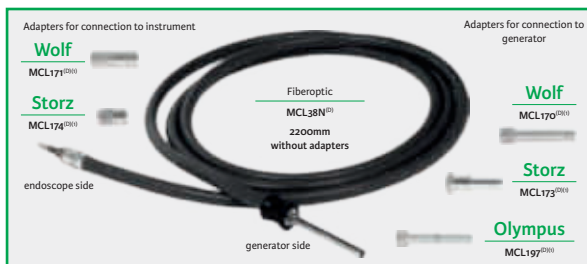

⁽¹⁾ Not a medical product

Light fiber

MCL89-2 Light fiber



Chest holder

MCL76 Laryngoscope arm holder without MCL35

MCL35 Plate for chest holder



Suction tube

MCL89-1 Suction tube for MCL206

MCL100 Blunt eyes suction tube



Container

7874MF-34 Stainless steel sterilization case 380x205x85mm 340x200x80mm



Silicone cover

MCM25-3 Silicone cover



^(D) Distributed by Integra MicroFrance SAS (France) - For corresponding manufacturer part numbers, see table in annex

Portmann



200mm

7857

Lecouteur



160mm

7800MF

Le Mée



7797-2

170mm

7797-1 small

7797-2 large

Scale 1/2

Birkett



200mm

7823

Schmidt



open ring

190mm

7822

Négus



200mm

7825

White



open ring

240mm

3731007

Bourgeois



200mm

7819

Portmann



open ring

200mm

7820

Chatelier



210mm

7826-1-7

Scale 1/2
Working length - «L»

St Claire Thompson

195mm
3731054
fenestrated jaws
6x13mm

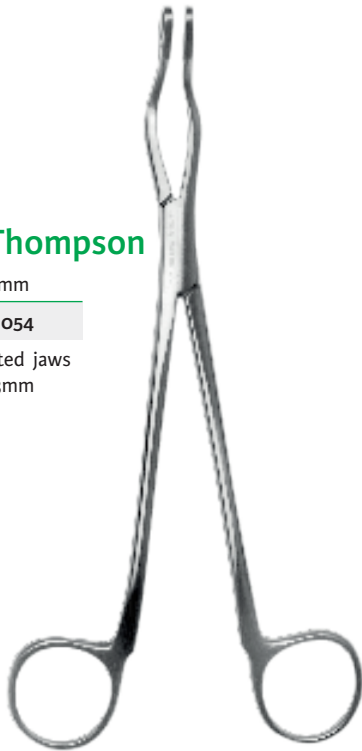

Ferris-Smith

L 115mm
3731055
serrated jaws
5.5x8mm



Allis-Coakley

190mm - with teeth - open ring

3731006	3731004
straight jaws 8mm	curved jaws 8mm



Adson

185mm - without teeth

3755143	3755147
straight	curved



Schnidt-Boettcher

190mm - without teeth - open ring

3731010	3731056	3731057
straight	curved	large curved



Schnidt

190mm - without teeth

3731058
curved

Scale 1/2



Jost
200mm
7879



Carpenter
220mm
7815



Hurd
220mm
7814M



Hurd
220mm
7814



Henke
220mm
7906



180mm
7878

**Monopolar cables
3.5m**



CP391E
Erbe ACC ICC/VIO
Storz Wolf



CP391M
Aesculap Berchtold
Lamidey
Martin Erbe T Serie
Sutter BM-780 II



CP391V
Bowa Bovie
Conmed Valleylab



Blondiau
230mm
7812
15x20mm



Ruault
210mm
7811



Lérault
200mm
7884
5mm



220mm
7895



200mm
1003LI^(D)
for blades 10/15

^(D) Distributed by Integra MicroFrance SAS (France) - For corresponding manufacturer part numbers, see table in annex

Yankauer

Suction tube
310mm

3734155

6mm
removalbe tip



Fisher

Tonsil knife
210mm

3734038

serrated blade
7x15mm



Hurd

Elevator
225mm

3734042

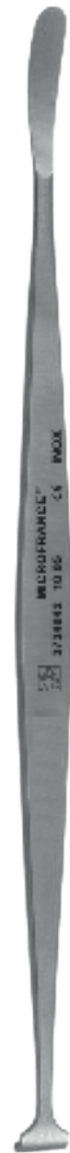

7mm

11mm

Scale 2/3



7828-1-13

Moure

220mm - without basket

	7828-1-10	6/10mm
	7828-1-13	8/13mm
	7828-1-16	10/16mm
	7828-1-19	12/19mm



7828-16

Moure

220mm - with basket

	7828-10	6/10mm
	7828-13	8/13mm
	7828-16	10/16mm
	7828-19	12/19mm



7829-10

Lermoyez

220mm - without basket



7829-10	5/10mm
7829-13	7/13mm
7829-16	9/16mm
7829-19	13/19mm

Lusk



Sterile, Single use - Pack 5

1423004	1423002	1423000
17mm	13mm	7mm
n°4	n°2	n°0

Laforce



Adenotome 230mm

3734018

16mm

Middleton



225mm

3734013

tip 10x25mm
7.5mm cutting edge

Scale 1/2

Working length «L»

Sluder

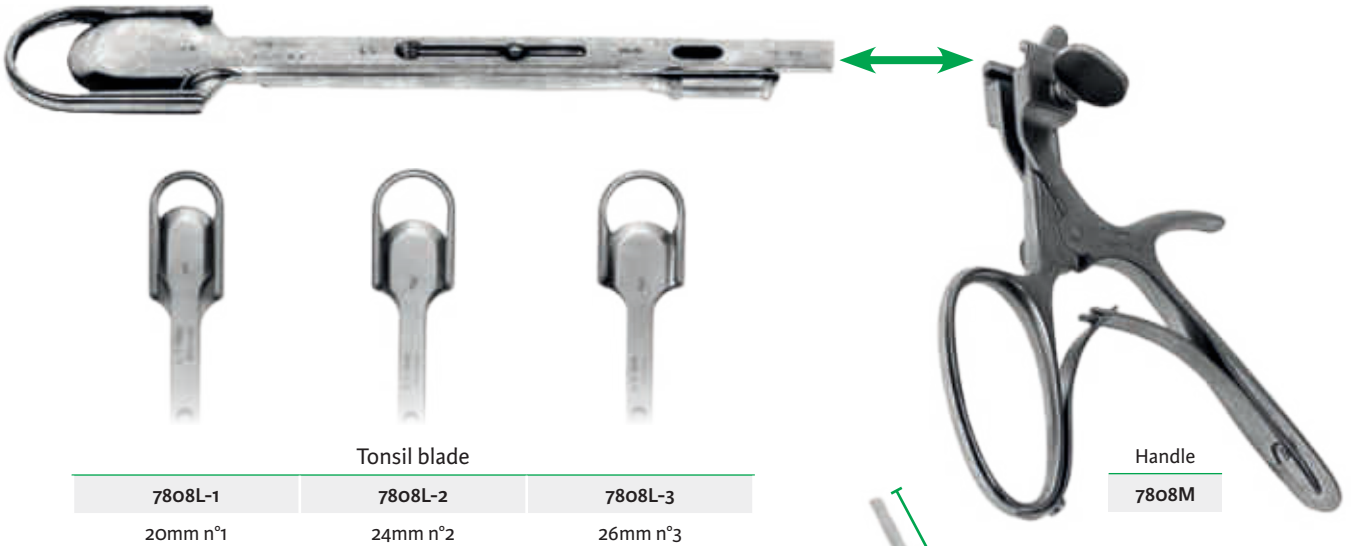

Tonsil blade		
7808L-1	7808L-2	7808L-3
20mm n°1	24mm n°2	26mm n°3

Handle
7808M

Brünings

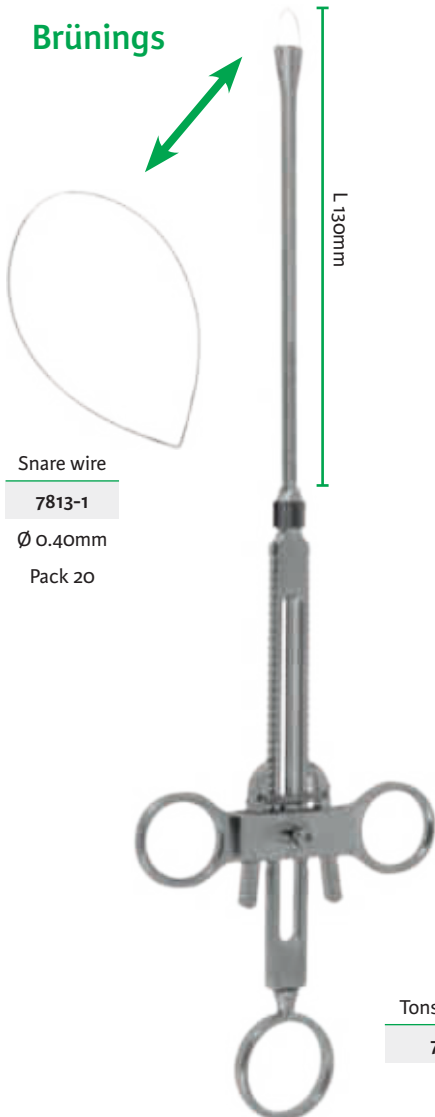

Snare wire
7813-1
Ø 0.40mm
Pack 20

Tonsil snare
7813

Vacher

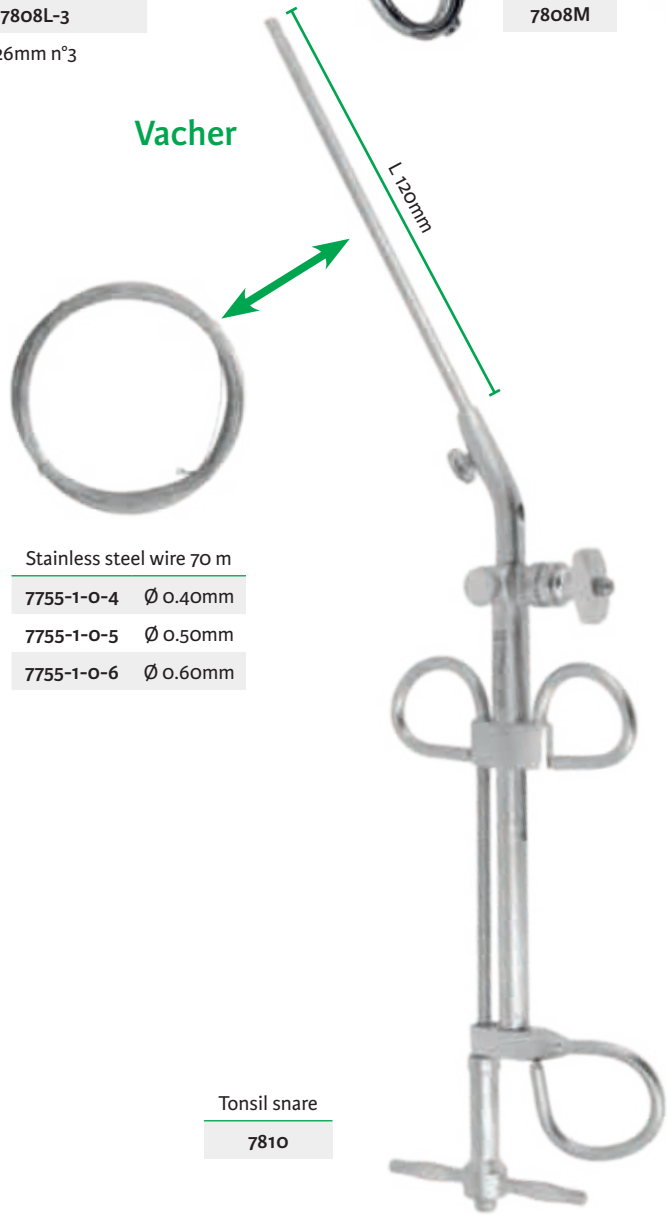

Stainless steel wire 70 m
7755-1-0-4 Ø 0.40mm
7755-1-0-5 Ø 0.50mm
7755-1-0-6 Ø 0.60mm

Tonsil snare
7810

Working length «L»

Scale 1/3

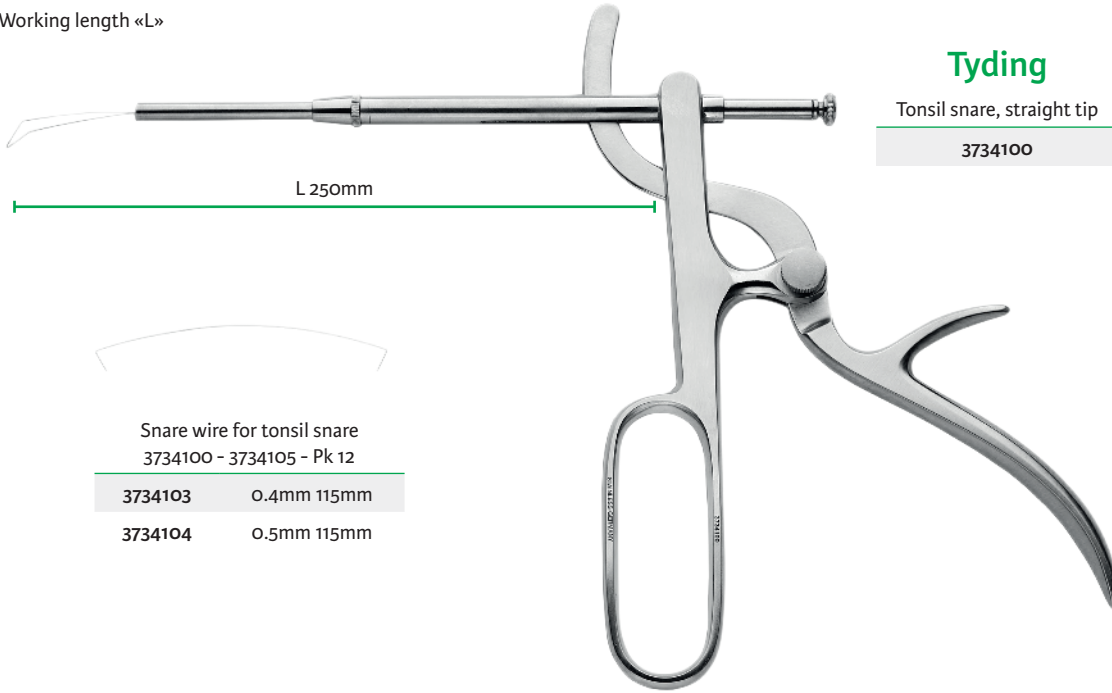

Tyding

Tonsil snare, straight tip

3734100

L 250mm



Snare wire for tonsil snare
3734100 - 3734105 - Pk 12

3734103	0.4mm 115mm
3734104	0.5mm 115mm

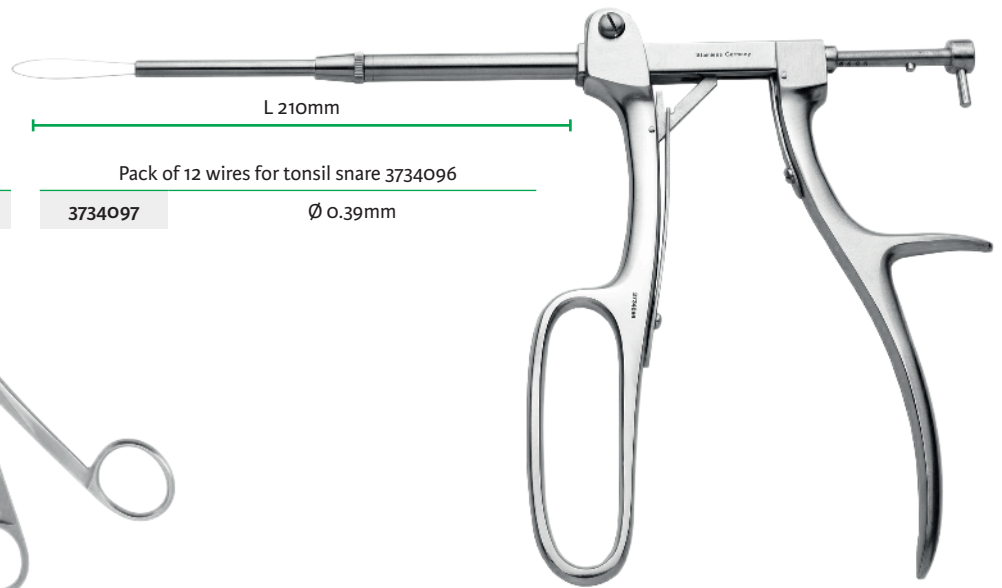

Sage

Tonsil snare

3734096

Pack of 12 wires for tonsil snare 3734096

3734097

Ø 0.39mm

L 210mm

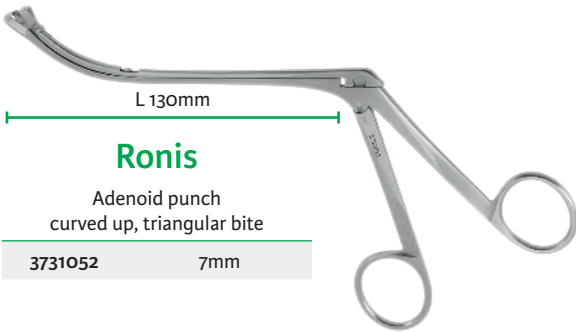

L 130mm

Ronis

Adenoid punch
curved up, triangular bite

3731052 7mm

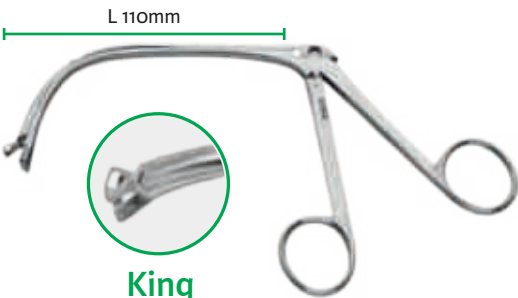

L 110mm

King

Adenoid punch
curved down, triangular bite

3731003 7mm

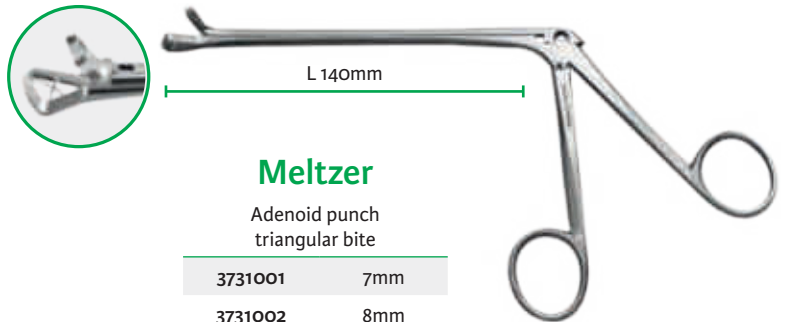

L 140mm

Meltzer

Adenoid punch
triangular bite

3731001 7mm

3731002 8mm

Scale 1/2

Laborde



Tracheal dilator

7840

120mm 80°

McCabe



Facial nerve dissector

3722089

140mm - 14mm angled jaws

Guerrier



Tracheal retractor

7838

180mm

Marie



Director

7839

145mm

Facial nerve dissector

7830M

160mm

Moure



Shear serrated blades

7835

200mm

Guerrier



«S» curved scissors

7921

180mm

O'Shaugnessy



Curved dissector

7837-18

180mm

Redon



7920

140mm

Working length «L»

Micro irrigation tube



MCM10-0-5 Ø 0.5mm L 30mm
MCM10-1-0 Ø 1mm

Micro vascular clamp



MCM9^(D)
30mm

Approximator L 13mm

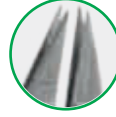

Large

MCM13



Small

MCM13-1

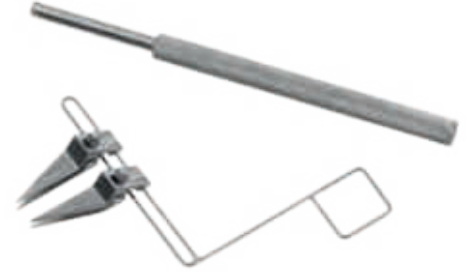

MCM13

Gilbert O'Brien

Micro dissecting forceps - 150mm



MCM4BISR



MCM4BISR

1x2 teeth and platform



MCM4R

Smooth jaws with plate

Jeweler forceps



130mm

MCM973D3 n°3



120mm

3740068 n°1



110mm

3740071 n°5



110mm

3740072

Angled jaws

^(D) Distributed by Integra MicroFrance SAS (France) - For corresponding manufacturer part numbers, see table in annex

Micro ciseaux

Vanas



MCM7BISR

8mm
Blunt curved

Vanas



MCM7R

8mm - serrated
straight blades



MCM970

8mm
atraumatic curved



MCM7BISR
150mm

Micro porte-aiguille

O'Brien



MCM12R

5x0.3mm
smooth curved jaws

Barraquer-Comtet



MCM1R

8mm
smooth straight jaws



MCM12R
150mm



MCEN136SC

290x175x55mm - 270x160x35mm

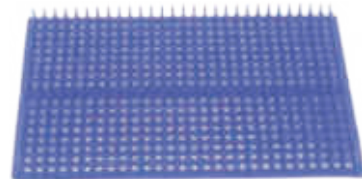

MCM25-3

210x130mm

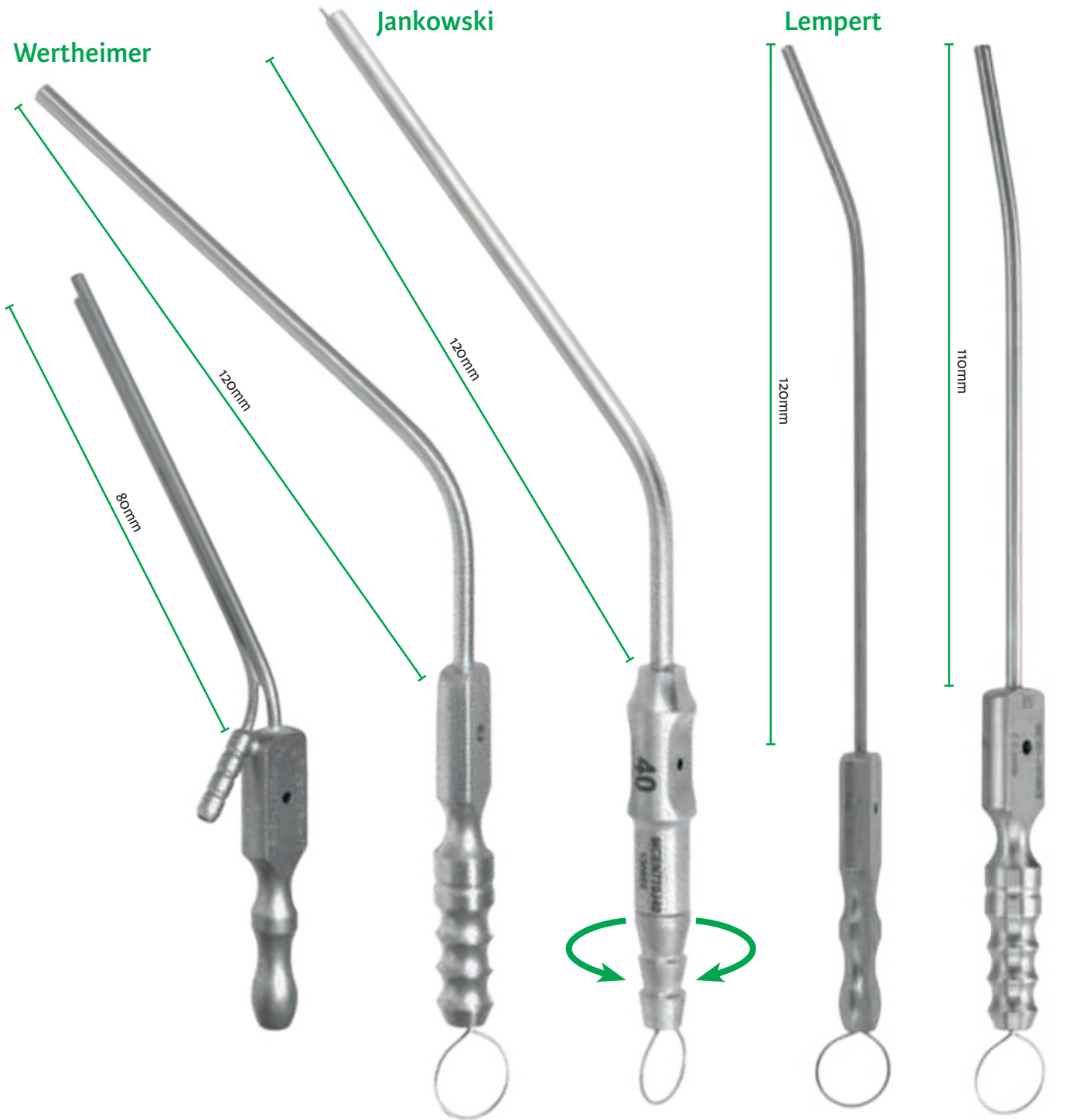

- 1.5mm
- 2mm
- 2.5mm
- 3mm
- 3.5mm
- 4mm

Wertheimer		Jankowski		Lempert	
MCO201-2-5	2.5mm	MCO770-1-5	1.5mm	MCO771-2-5	2.5mm
MCO201-3-0	3mm	MCO770-2-0	2mm	MCO771-3-0	3mm
		MCO770-2-5	2.5mm	MCO771-4-0	4mm
		MCO770-3-0	3mm		
		MCO770-3-5	3.5mm		
		MCO770-4-0	4mm		
		MCEN770J40	4mm	CP330-3-0	3mm
		MCEN770J30	3mm	CP330-4-0	4mm

Sébileau

Fleury

Freer

Howarth

Cottle

McKenty



190mm

CP985

5mm



180mm

MCO305

8.5mm



160mm

MCO803

2.5mm



185mm

CP611

5mm



220mm

CP625



220mm

CP626



240mm

CP627



120mm

1003IG^(D)

N° 3



160mm

1005I^(D)

N° 7



200mm

1003LI^(D)

N° 3L



150mm

CP821

N° 3



120mm

1004IG^(D)

N° 4

Utilisation avec lames 11/15

lames 23

^(D) Distributed by Integra MicroFrance SAS (France) - For corresponding manufacturer part numbers, see table in annex

Farabeuf

Fleury

Sébileau

Plester

Lempert



150mm

7787-10

10mm



170mm

MCO979

6,5mm



150mm

CP825

4mm



180mm

MCO988

7,5mm



185mm

3724060

7mm



195mm

3724059

6,5mm

Joseph

Obwegeser



180mm

CP310

5mm

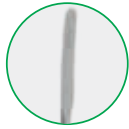

180mm

CP310D

5mm
straight

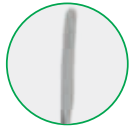

180mm

CP310E

4mm

CP310



CP344A

Obwegeser

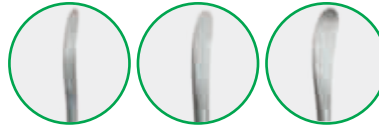

180mm

CP344A

5mm

CP344B

7mm

CP344C

11mm

Obwegeser-Tessier

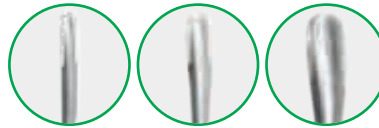

180mm - sharp

CP344AT

5mm

CP344BT

7mm

CP344CT

11mm

Obwegeser



190mm

CP344D

7mm
curved

CP344E

7mm
very curved

Obwegeser-Tessier



190mm - tranchante

CP344DT

7mm
curved

CP344ET

7mm
very curved

Farabeuf



140mm 120mm
7768-1 7768
Pk 2 Pk 2

Desmarres



140mm
CP822-12
12mm
CP822-10
10mm
CP822-14
14mm

Gillies



180mm
CP17
3mm
CP17-1
2mm

Gillies



145mm
CP17-3
2mm
CP17-2
3mm



145mm
CP628
5mm

Humby



110mm
CP941
articulated

Knapp



150mm

3714027

8mm

3714028

blunt



140mm

CP21-3

pointu

CP21A-3

blunt

Volkman



150mm

7782-1-2



180mm

CP335



160mm

CP609

3 sharp prongs

Weitlaner

Weitlaner



curved

160mm

0-28-7

sharp prongs



3724244

straight

165mm

200mm

3724244

3724247

sharp prongs

sharp prongs

Bizeau

165mm

MCL359

blades 20x30mm

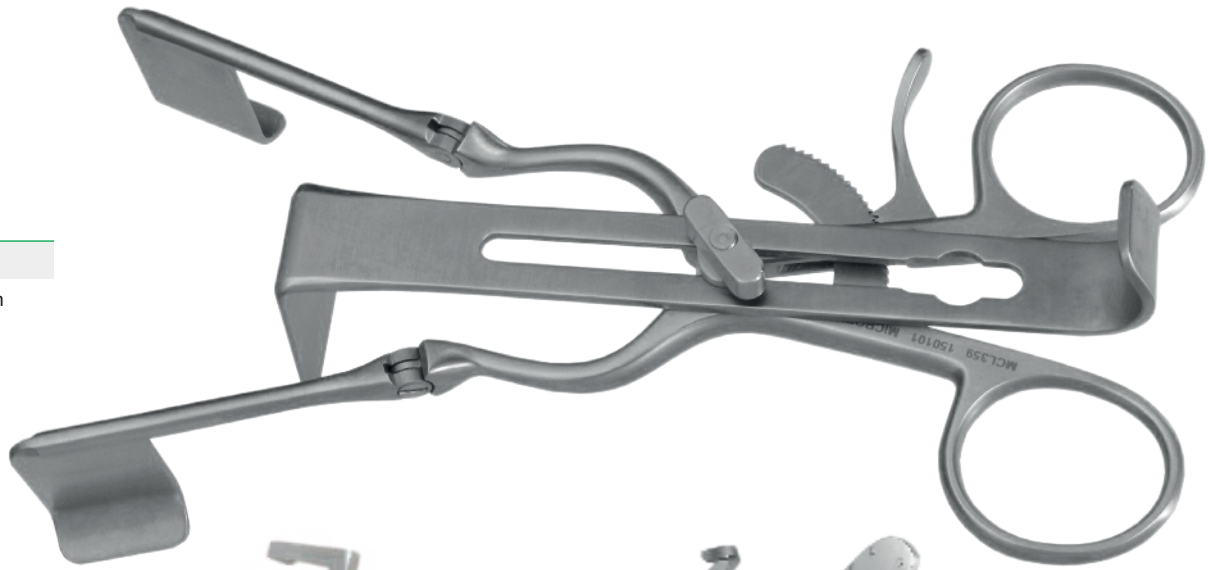

Weitlaner-Beckmann

165mm

7781



House

165mm

1352247

blunt prongs
right

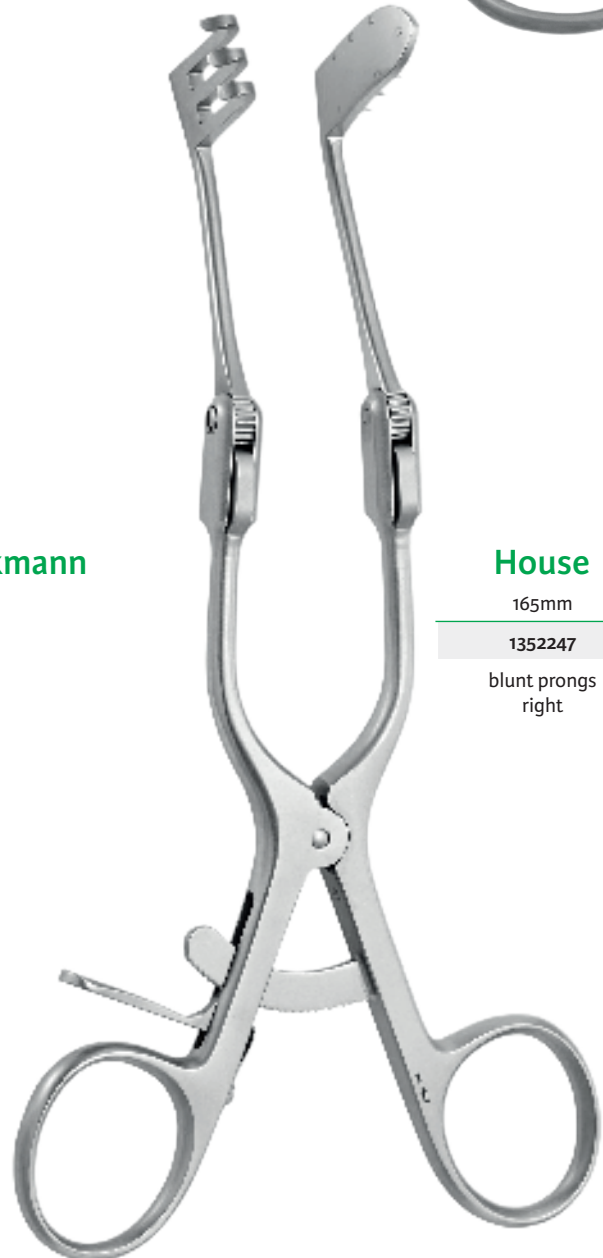

Malleable



210mm

CP818-8



8mm

10mm

12mm

15mm

20mm

CP818-8

CP818-10

CP818-12

CP818-15

CP818-20

Dautrey



15x40mm

15x55mm

140mm

CP984

Dautrey



15x60mm

15x85mm

140mm

CP984-1

Malleable



10mm

15mm

Blade retractor
10/15mm - 160mm

7773

Scale 2/3



200mm

CEV418

Pack 2



Descottes

200mm

CEV417

Pack 2

Mosnier



160mm

CEV419

Pack 2

Pessey



180mm

CP335P

Leroux-Robert



160mm

7923

Scale 3/4

Streiff



CP16-1

105mm

CP16-1	CP16
curved blades	straight blades



100mm

CP353
Strong curvature

Offret



100mm

CP356

Joseph



CP354A

120mm

CP354A	CP354
curved blades	straight blades

Joseph



CP919A

110mm

CP919A	CP919
curved blades	straight blades

Fox



CP358A

110mm

CP358A	CP358
curved blades	straight blades

Kilner-jost



120mm

CP362

Curved

Boetcher



180mm

CP997

Curved

Brophy



CP367-1

150mm

CP367-1

CP367

Curved

Straight

Joseph



CP355A

150mm

CP355A

CP355

Curved

Straight

Scale 3/4

Shea



120mm

CP637

curved blades

Bregeat



110mm

CP363

curved blades

Stevens



110mm

CP922A

curved tenotomy scissors

Stevens



110mm

CP922

straight blades

Stevens



115mm

CP922B

curved tenotomy scissors

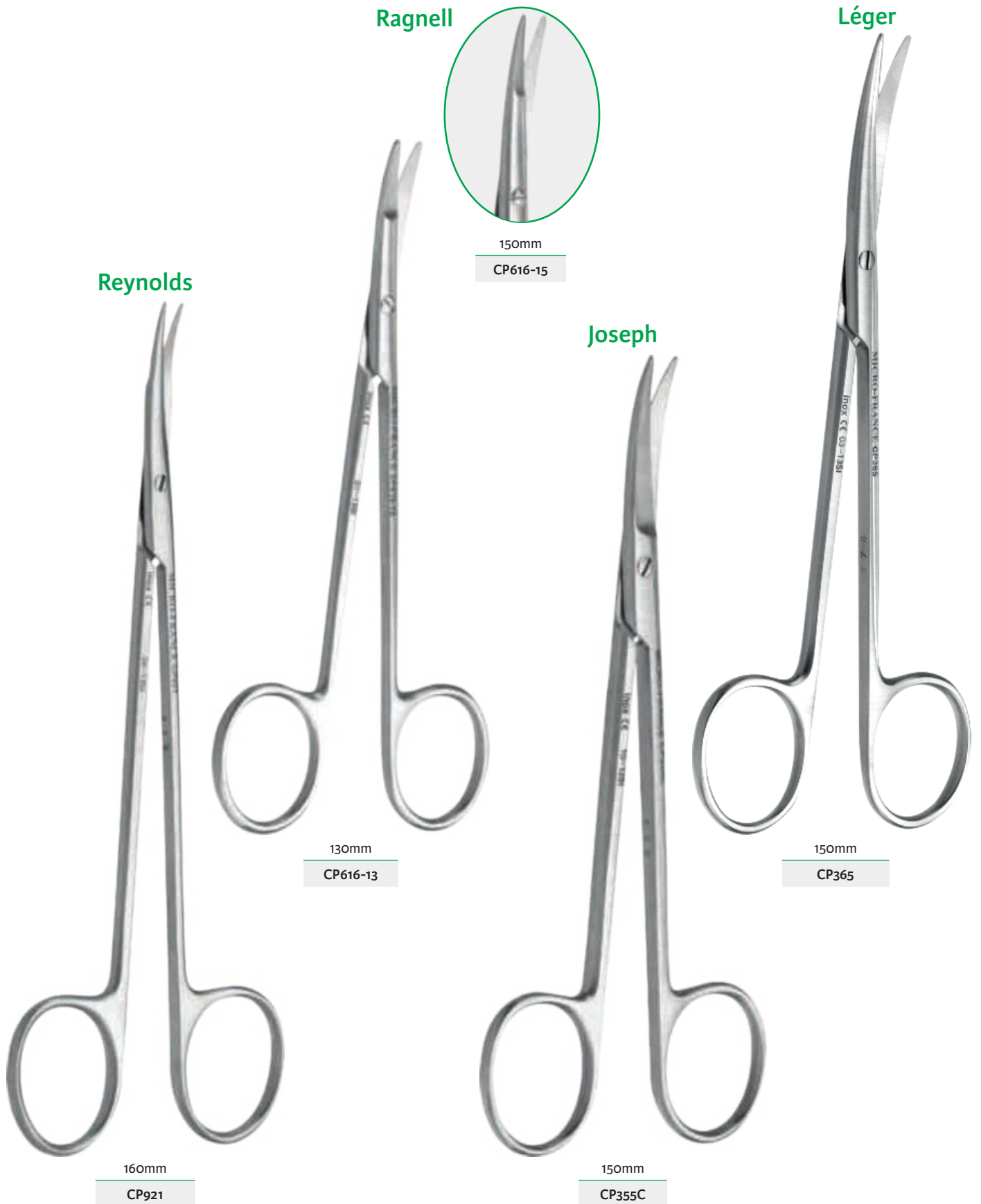

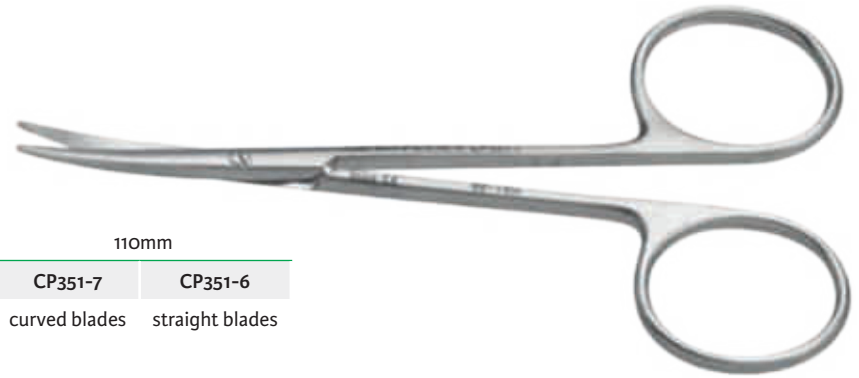

110mm

CP351-7	CP351-6
curved blades	straight blades

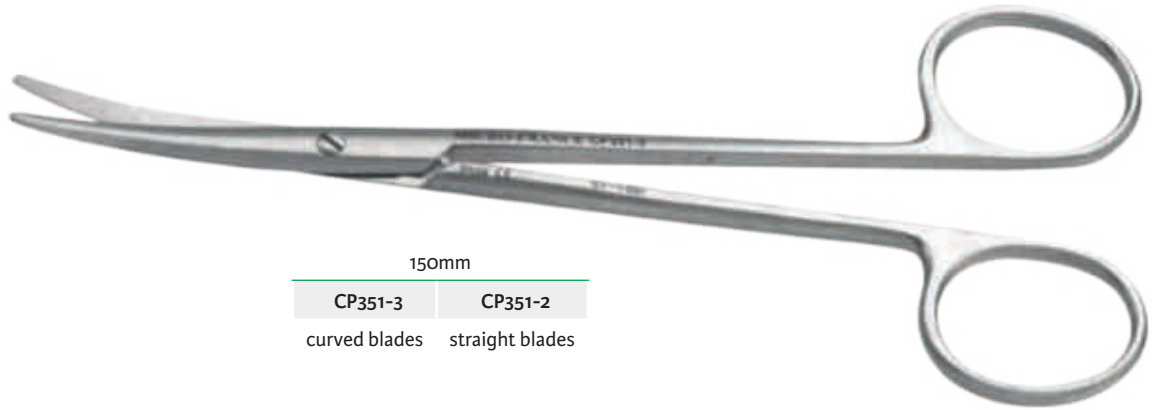

150mm

CP351-3	CP351-2
curved blades	straight blades

Delicate blades



150mm

CP931-1	CP931
curved blades	straight blades



CP351-5

Curved standard

CP351-5	CP351-1
200mm	180mm



CP931-5

Curved, delicate blades

CP931-5	CP931-3
200mm	180mm



Dissecting forceps 110mm

Castroviejo



CP938-1

Horizontal 1x2 teeth and platform

Castroviejo



CP37

Oblique 1x2 teeth and platform



CP332

Serrated jaws 1.4mm

Dissecting forceps 120mm



CP414

Jaws 1mm



serrated jaws

7831A-12

Jaws 1.5mm



3740012

Jaws 3mm



CP406

1x2 teeth - Jaws 1mm



Jaws with teeth

7833A-12

1x2 teeth - Jaws 1.5mm



CP400-1

5x5 griffes

150mm

Adson



- CP604-15 serrated jaws 1.5mm
- CP605-15 1x2 teeth 1.5mm jaws

Adson-Brown



- CP606-15 7x7 teeth

120mm



Adson-Tubiana

Adson

Adson-Brown

Adson-Tubiana		Adson		Adson-Brown			
Jaws 1mm		Jaws 1.5mm		Jaws 2mm	Jaws 1.5mm	Jaws 7x7 teeth	
M832	M833	CP604	CP605	3740028	CP606A	CP606	3740038
serrated	1x2 teeth	serrated	1x2 teeth	2x3 teeth	tungsten serrated		angled jaws

Mac-Indoe

140mm



CP934 Oblique 1x2 teeth and serrated platform

CP934-1 Serrated jaws

Debaquey

Barraya



150mm

140mm

CP415	7831A-15	CP407	7833A-15	CP988-15	CP933-14	CP400
serrated jaws 1mm	serrated jaws 1.5mm	1x2 teeth jaws 1mm	1x2 teeth jaws 1.5mm	serrated jaws 1.5mm	3x4 teeth & serrated platform	5x5 teeth



110mm

Cottle

3740067

Jaws 14mm - Columella forceps

Graefe

3740049

Jaws 4.5mm - Fixation forceps with lock

Précelle



150mm

CP345

serrated angled jaws



150mm

3740015

3mm serrated jaws



150mm

3740019

3mm 1x2 teeth

Barraya



160mm

CP933-16

3x4 teeth and serrated platform

Claoué



160mm

CP401

5x6 teeth

Mac-Indoe



170mm

CP936

1x2 teeth and serrated platform

Debaquey

Potts-Smith

Barraya



1.5mm
7831A-18



1.5mm
CP988-18



1mm
CP409
1x2



1.5mm
7833A-18
1x2



3mm
3740090
1x2



1.5mm
CP933-18
3x4 teeth and
serrated platform



6x6
CP400-2

Debakey



200mm	210mm
7832	7834
1mm serrated	1mm 1x2 teeth



2mm
7831A-20



1,5mm
CP988-20



2mm
7833A-20
1x2 teeth

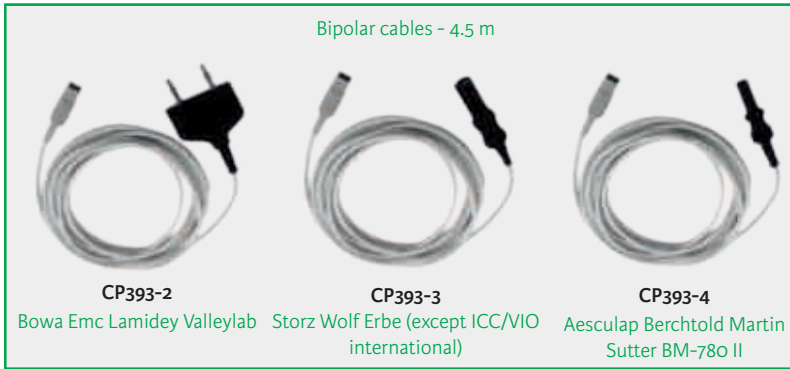

Magnan



Adson



110mm		120mm		160mm		200mm	
CP392-1R	CP604BR	CP605BR	CP392-2R	CP392-8R	CP392BI	CP392BS	
smooth jaws 1x8mm	serrated Jaws 1.5mm	1x2 teeth 1.5mm	smooth jaws 1x8mm	smooth jaws 1x8mm	smooth jaws 0.5x5mm	smooth jaws 0.5x5mm	



Bipolar cables - 4.5 m



CP393-2
Bowa Emc Lamidey Valleylab



CP393-3
Storz Wolf Erbe
(except ICC/VIO international)



CP393-4
Aesculap Berchtold Martin
Sutter BM-780 II

CP392-3R Straight smooth jaws 1x8mm	CP392-10R Angled tip smooth jaws 1x8mm	CP392-5R Bayonet smooth jaws 1x8mm	CP392-9R Bayonet Angled down jaws 1x8mm
---	--	--	---

Dousset



Belghiti

Soubrane

Gayet

Partenski



300mm	230mm	230mm	230mm	240mm	210mm
CEV392D30	CEV392D20	CEV392P20	CEV392S20	CEV392G24	CEV392R15
Jaws 3mm	Jaws 2mm	Jaws 2mm	Jaws 2mm	Jaws 5x15mm	Jaws 4x10mm



Adson



110mm

CP390-1

smooth jaws 1x8mm



120mm

CP604M

serrated jaws 1.5mm



CP605M

1x2 teeth 1.5mm



160mm

CP390-2

smooth jaws 1x8mm



CP390-8

1x2 teeth 1x8mm

Scale 2/3

Working length - «L»

Chambon



290mm L 260mm

CP390L26

smooth jaws 1x8mm



CP390-3

smooth jaws 1x8mm



230mm L 200mm

CP390-5

angled jaws 1x8mm



CP390-7

smooth jaws 1x8mm

Monopolar cables 3.5m



CP391E

Erbe ACC ICC/VIO
Storz Wolf



CP391M

Aesculap Berchtold Martin
Erbe T Serie Lamidey
Sutter BM-780 II



CP391V

Bowa Bovie Conmed Valleylab

Halsey

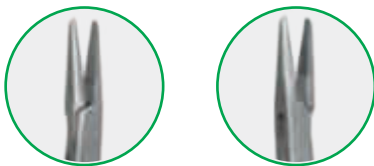

130mm

703T

serrated jaws

704T

smooth jaws



703T

Ryder

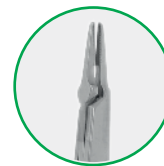

130mm

3744027

Jaws 1mm



Crile-Wood Mayo-Hégar

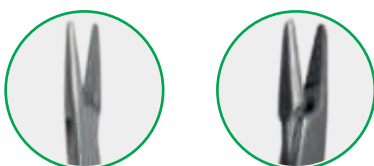

150mm

702T

714T



702T

Becker



130mm

CP1107

diamond jaws

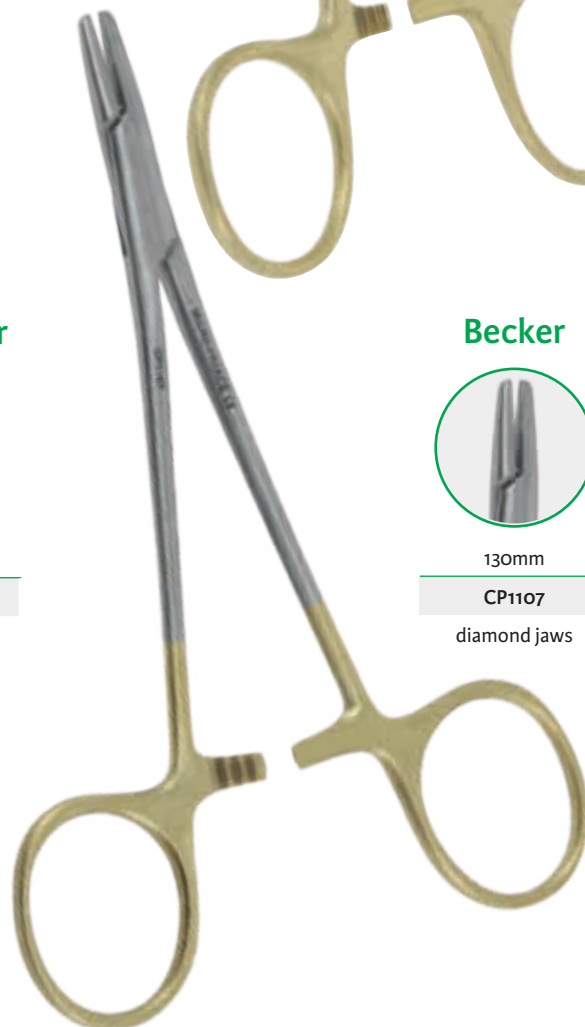

Scale 2/3

Crile-Wood



200mm

720T

Crile-Wood



180mm

701T



Stratte



210mm

7945T



Hartmann-Mosquito

95mm - without teeth

3755111	3755110
Curved	Straight

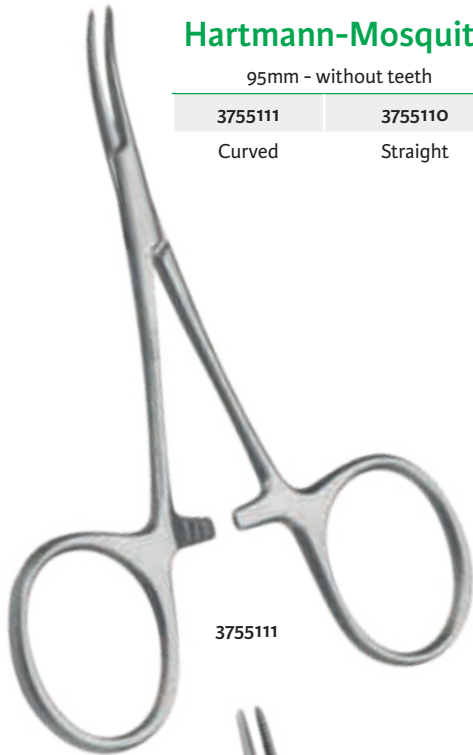

3755111

Halsted-Mosquito

120mm - without teeth

3755102	3755101
Curved	Straight



3755102



Mosquito

120mm - without teeth

3755107	3755106
Curved	Straight
delicate jaws	

Leriche

140mm - without teeth

7867-1	7867-2
Straight	Curved

140mm - with teeth

7867-3	7867-4
Straight	Curved



7867-1

Halsted

120mm - with teeth

P761-7	P761-8
Straight	Curved



P761-7

Crile

140mm - without teeth

3755116	3755117
Straight	Curved



Kelly

without teeth

	140mm	160mm
3755114	P762-2	P762-4
Straight	Curved	Curved



Rochester-Péan

170mm - without teeth

3755136
Curved



Kocher

140mm 160mm 180mm

Straight without teeth		
P764-1	P764-5	-
Straight with teeth		
P764-3	P764-7	P764-11

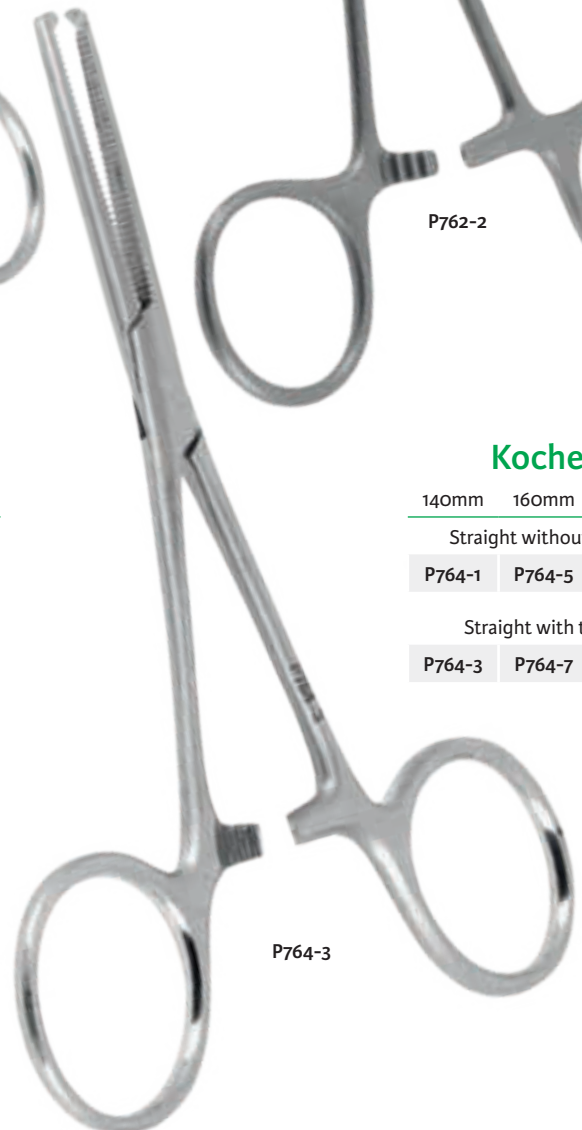



130mm

3755010

Towel clamp
serrated jaws



Martel

130mm

P763

Forceps with teeth
'T' tip

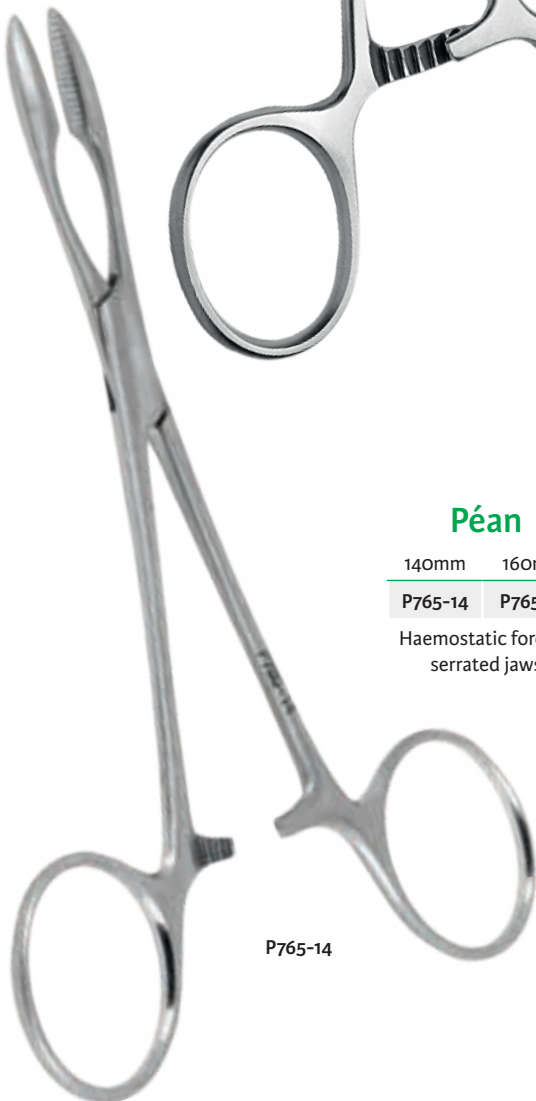

Péan

140mm 160mm

P765-14 P765-16

Haemostatic forceps
serrated jaws

P765-14

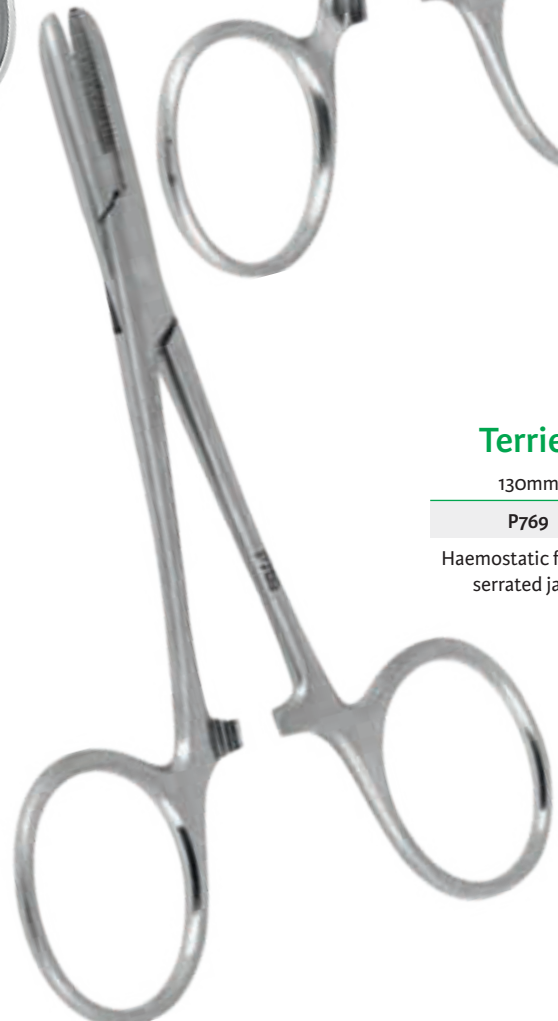

Terrier

130mm

P769

Haemostatic forceps
serrated jaws



Backauss

90mm 120mm

3755000 3755001

Towel clamp

3755000



Allis

Forceps with teeth

140mm 150mm

3755160 3755161

3x4 teeth 4x5 teeth

3755161



Chaput

Forceps with teeth

130mm

7866-13

2x3 teeth



Babcock
Straight jaws
without teeth
160mm
3755100



Ombredanne
with teeth
130mm
P771

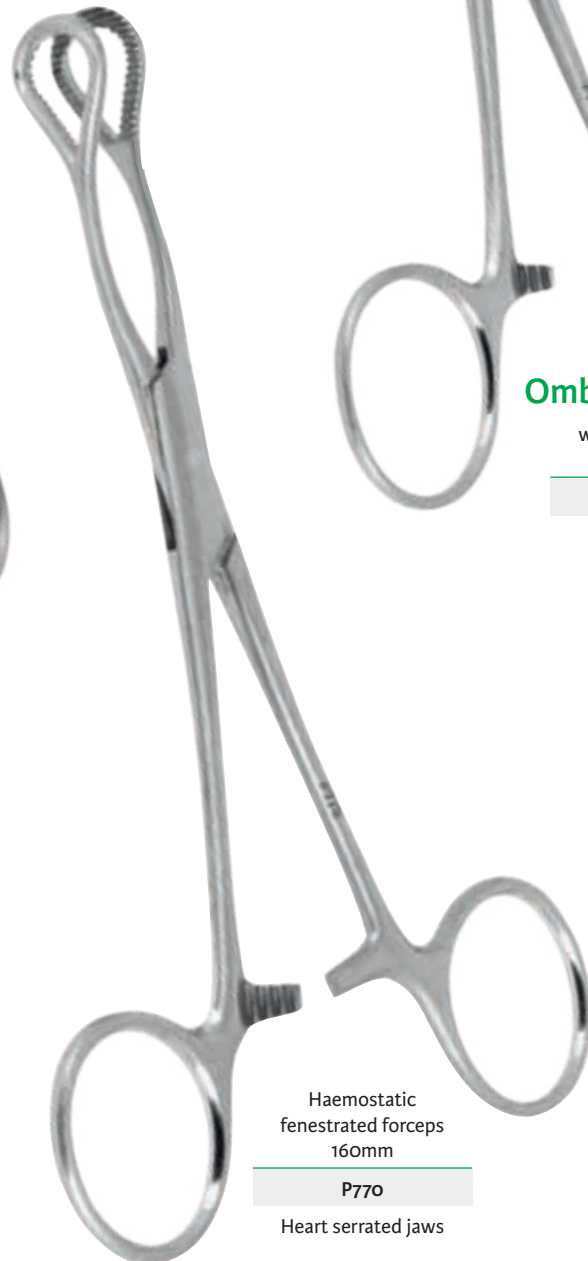

Haemostatic
fenestrated forceps
160mm
P770
Heart serrated jaws

Blunt eyes suction tube

Scale 1/4

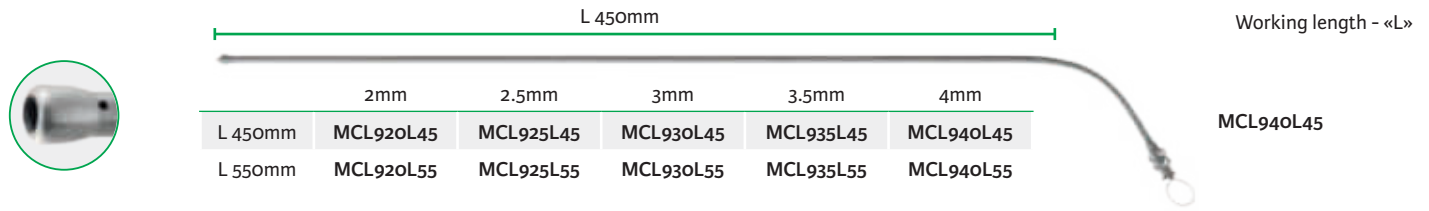

Working length - «L»

	2mm	2.5mm	3mm	3.5mm	4mm
L 450mm	MCL920L45	MCL925L45	MCL930L45	MCL935L45	MCL940L45
L 550mm	MCL920L55	MCL925L55	MCL930L55	MCL935L55	MCL940L55

MCL940L45

Forceps



L 400mm

Forceps	Crocodile forceps	Cup forceps Ø 4mm	Cup forceps up opening 3.5x10mm	Cup forceps upward Ø 4mm
L 400mm	7844T3L40	7844T5L40	7844T6L40	7844T7L40
L 450mm	7844T3L45	7844T5L45	7844T6L45	7844T7L45
L 500mm	7844T3L50	7844T5L50	7844T6L50	7844T7L50
L 550mm	7844T3L55	7844T5L55	7844T6L55	7844T7L55
L 600mm	7844T3L60	7844T5L60	7844T6L60	7844T7L60

7844T5L40

Esophagoscope

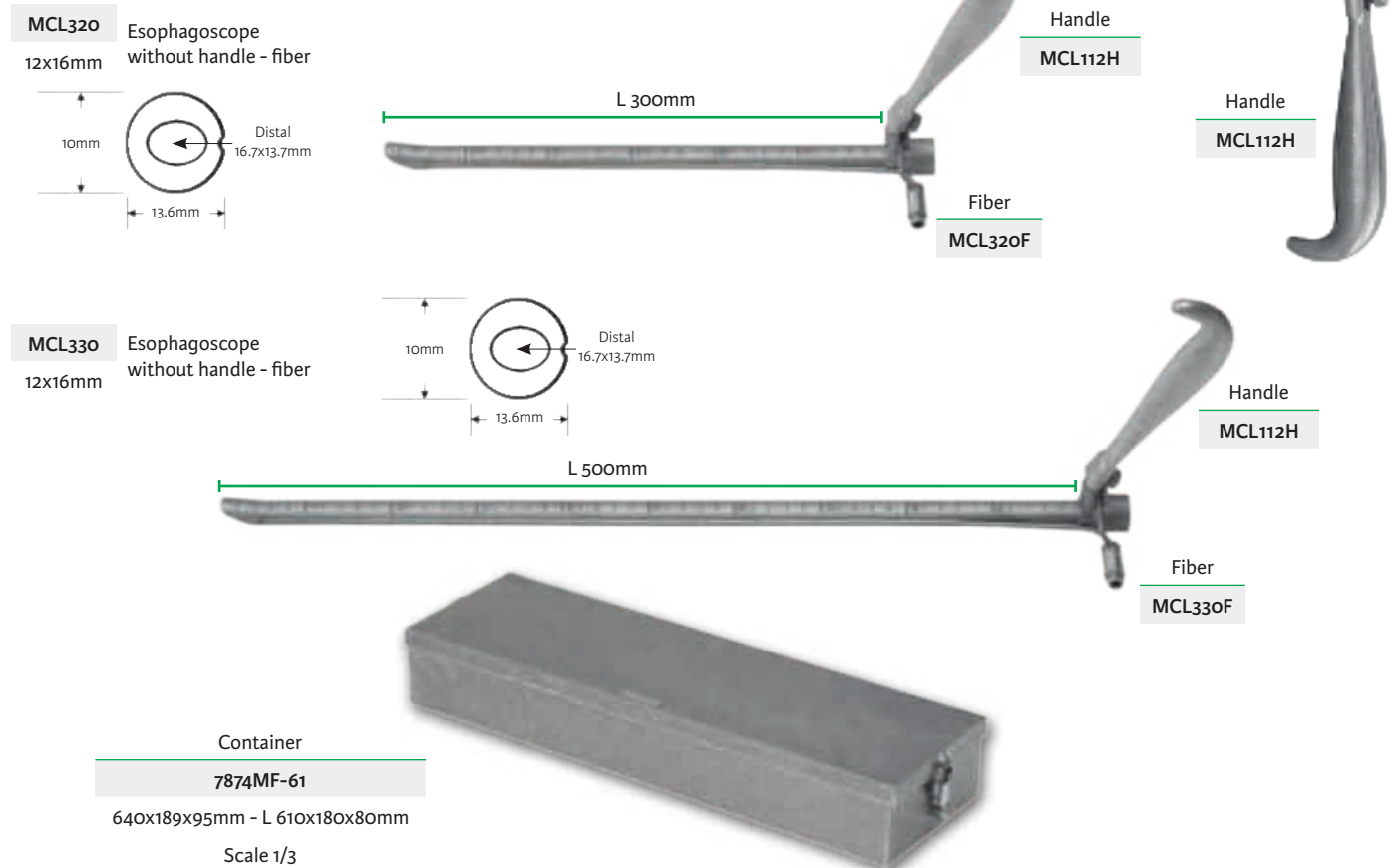

MCL320 Esophagoscope without handle - fiber
12x16mm

Distal 16.7x13.7mm

10mm

13.6mm

L 300mm

Handle MCL112H

Fiber MCL320F

MCL330 Esophagoscope without handle - fiber
12x16mm

Distal 16.7x13.7mm

10mm

13.6mm

L 500mm

Handle MCL112H

Fiber MCL330F

Container
7874MF-61
640x189x95mm - L 610x180x80mm

Scale 1/3

Scale 1/4

Working length - «L»



Blunt eyes suction tube

	2mm	2.5mm	3mm	3.5mm	4mm	
L 250mm	MCL920L25	MCL925L25	MCL930L25	MCL935L25	MCL940L25	MCL930L25
L 350mm	MCL920L35	MCL925L35	MCL930L35	MCL935L35	MCL940L35	

Forceps

Forceps	Crocodile forceps	Cup forceps Ø 4mm	Cup forceps up opening 3.5x10mm	Cup forceps upward Ø 4mm	
L 200mm	7844T3L20	7844T5L20	7844T6L20	7844T74L20	7844T5L25
L 250mm	7844T3L25	7844T5L25	7844T6L25	7844T74L25	
L 300mm	7844T3L30	7844T5L30	7844T6L30	7844T74L30	
L 350mm	7844T3L35	7844T5L35	7844T6L35	7844T74L35	

L 220mm

Cup forceps
up opening

7843-1

3.5x10mm

L 220mm

Cup forceps curved down up opening

7843A-1

3.5x10mm

Jackson

L 280mm

Alligator forceps serrated jaws

3734218

4x22mm

MCL110

Hypopharyngoscope 9x14mm
without fiber

L 200mm

Fiber

MCL111

Hypopharyngoscope

MCL112

Hypopharyngoscope
12x16mm
without handle - fiber

L 200mm

Fiber

MCL112F

Handle

MCL112H

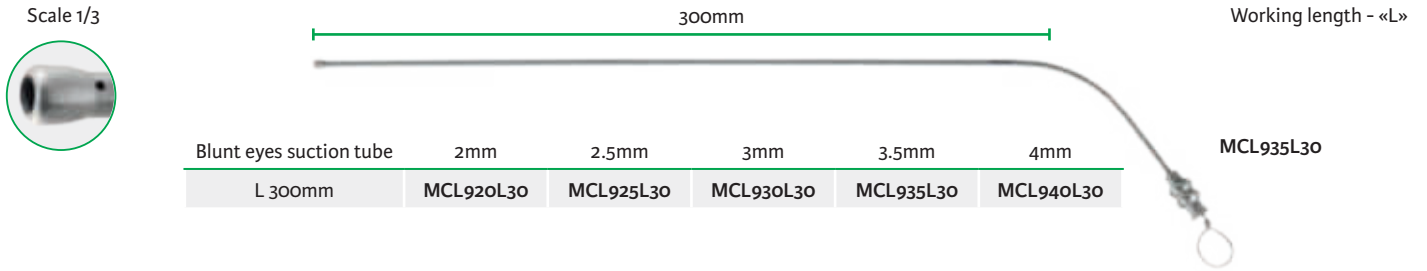

Lacau diverticuloscope

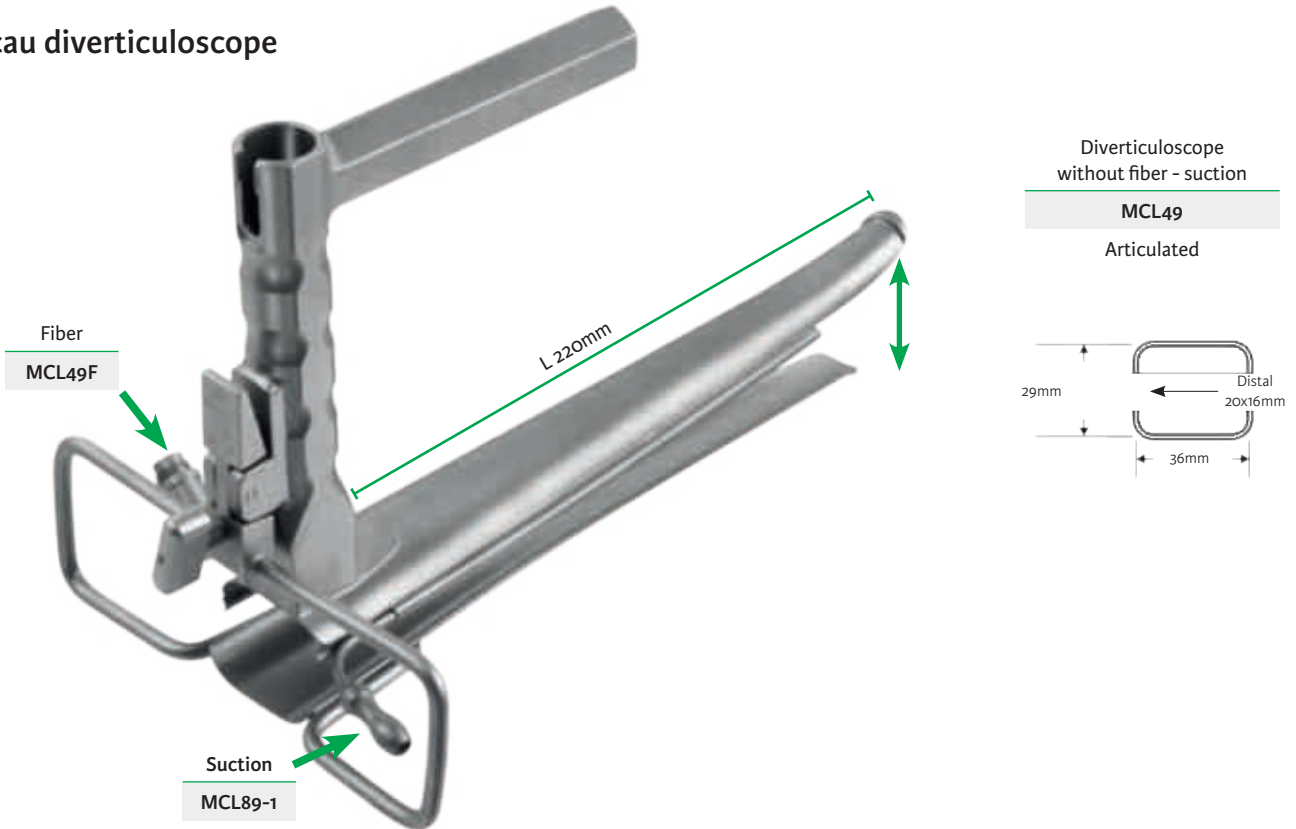

Reyt diverticuloscope

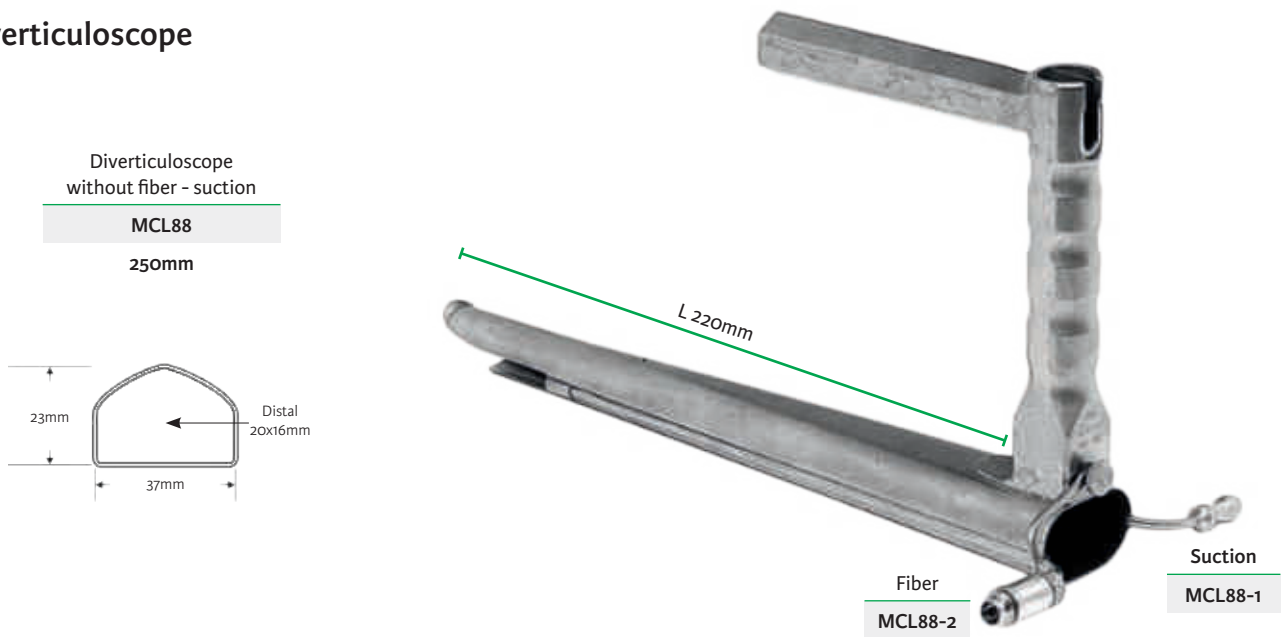

Picture for information, without scale

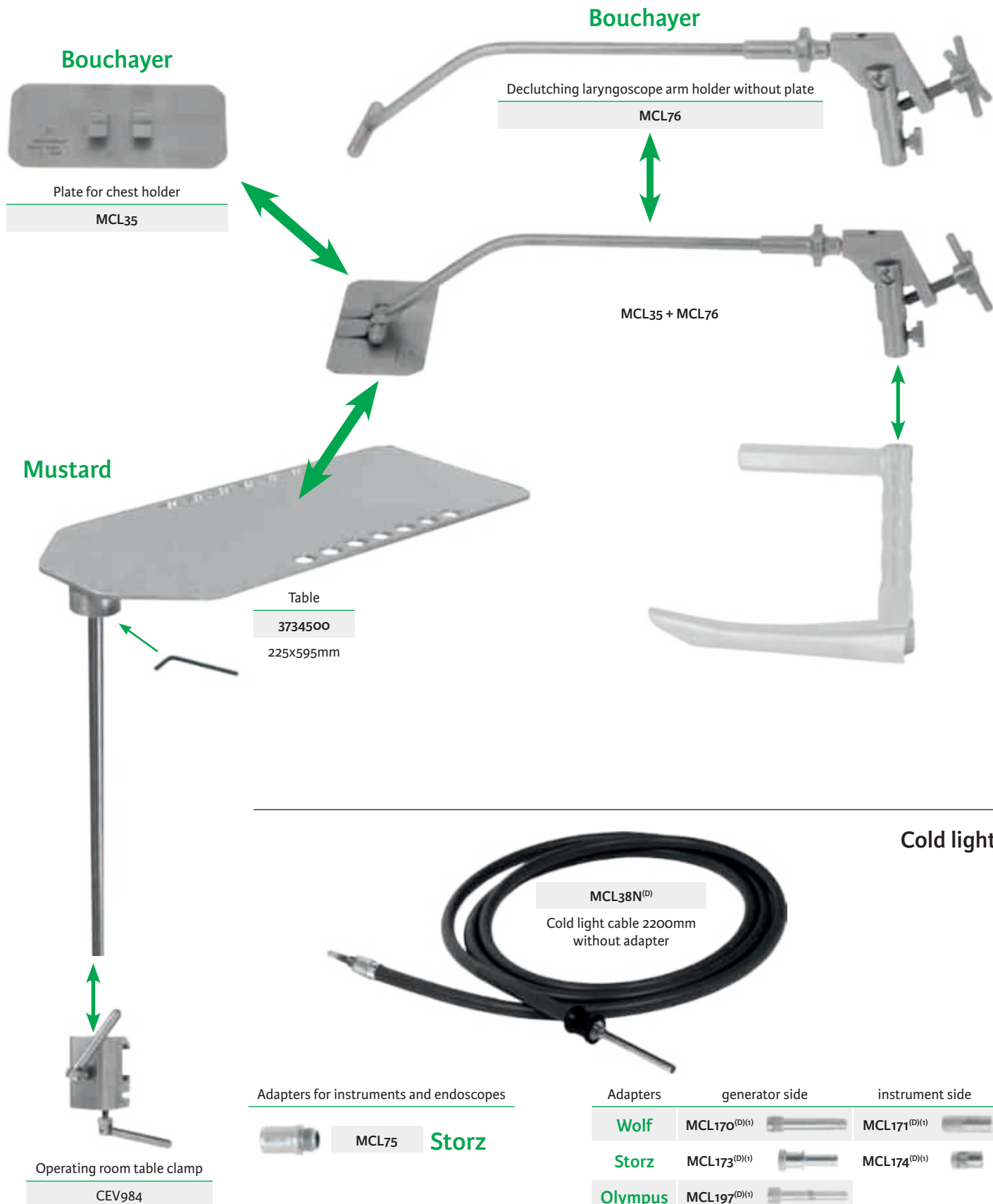

^(t) Not a medical product

^(D) Distributed by Integra MicroFrance SAS (France) - For corresponding manufacturer part numbers, see table in annex

Scale 1/3

Working length - «L»

Lescanne

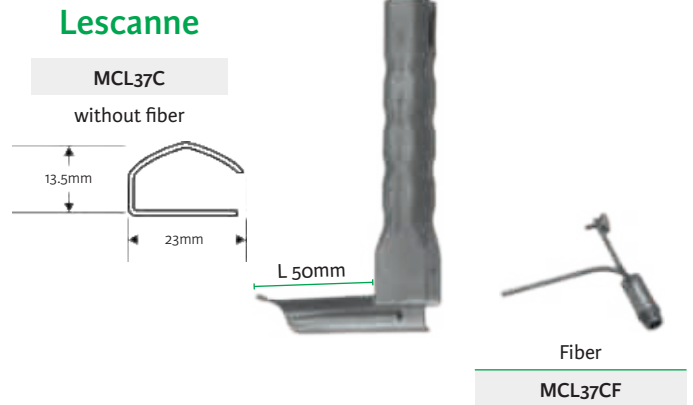
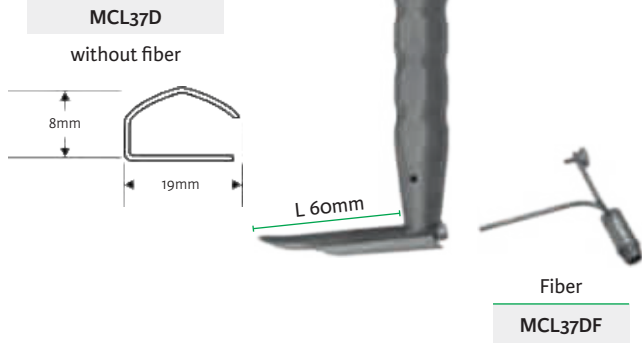

Garabédian

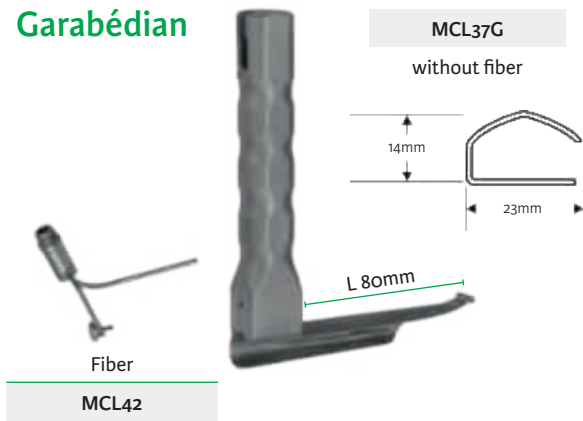

Garcin

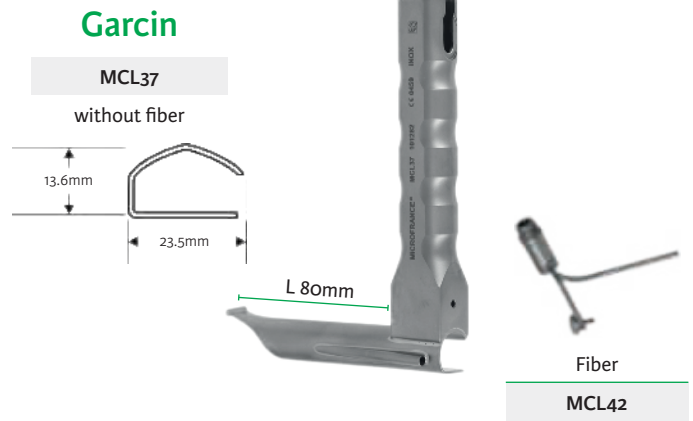

Legent

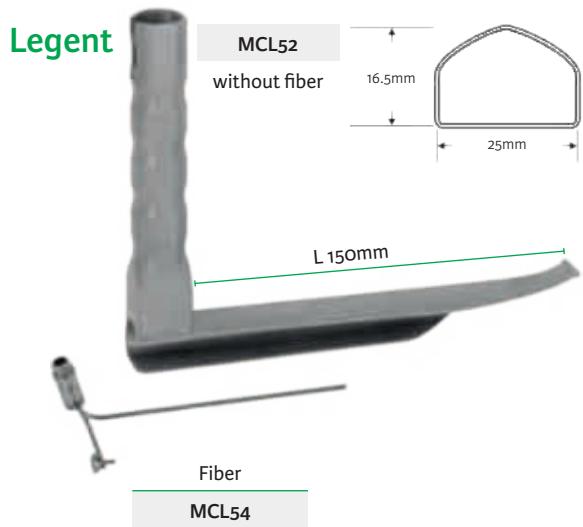

Legent

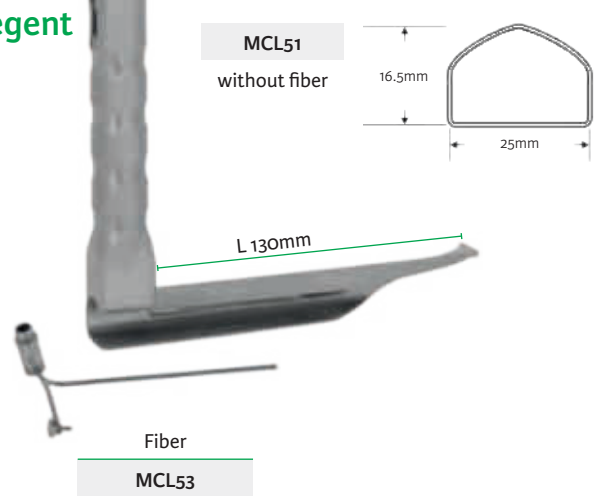

Scale 1/3

Working length - «L»

Bouchayer

MCL79
without fiber

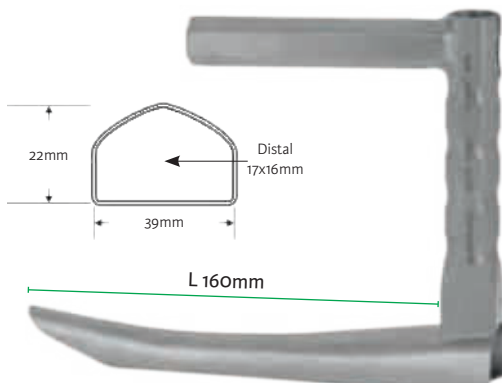

Bouchayer

MCL77
without fiber

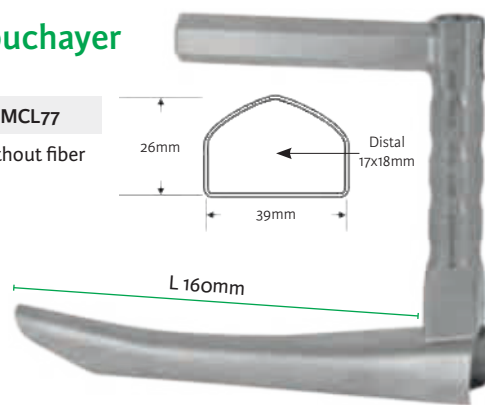

Fiber
MCL78

Pignat

MCL64
without fiber
small size

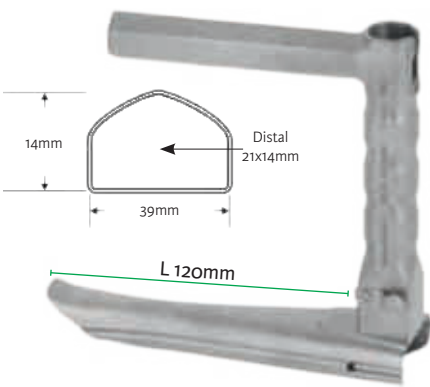

Pignat

MCL63
without fiber
large size



Fiber
MCL64F

Fiber
MCL63F

Scale 1/3

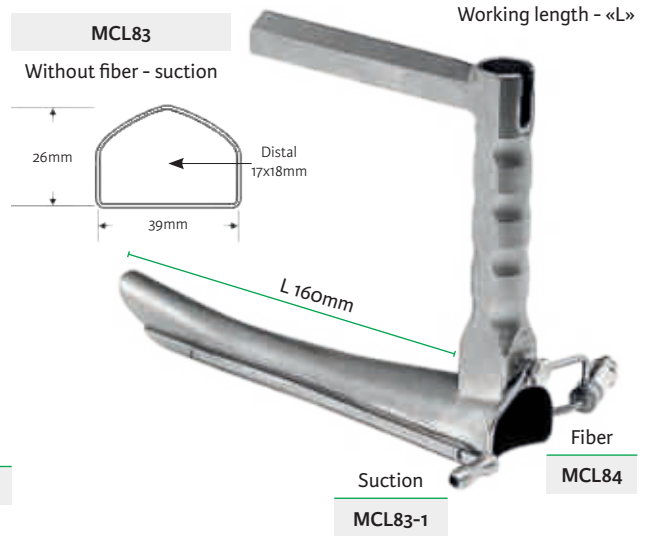
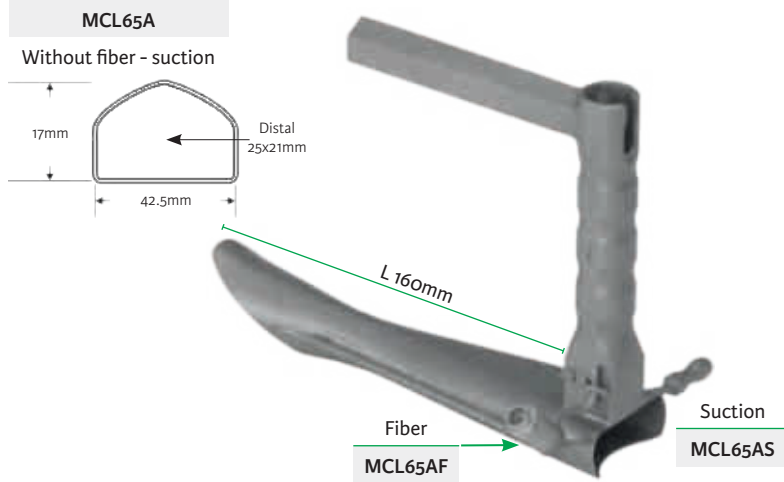

Abitbol

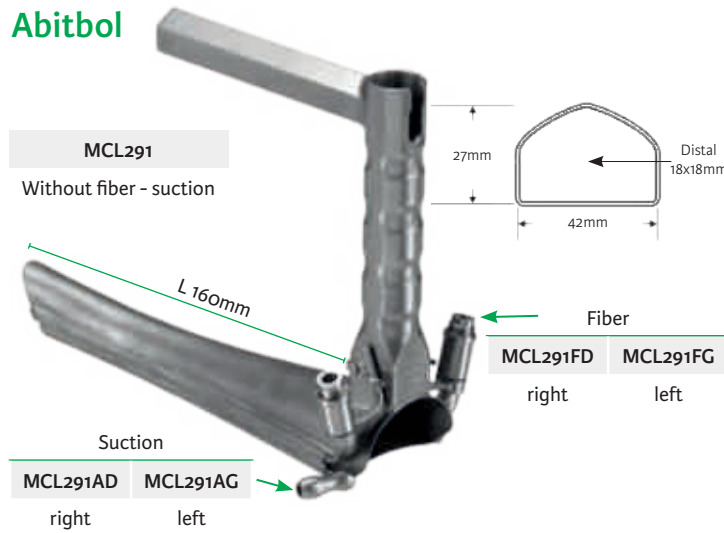

Brasnu

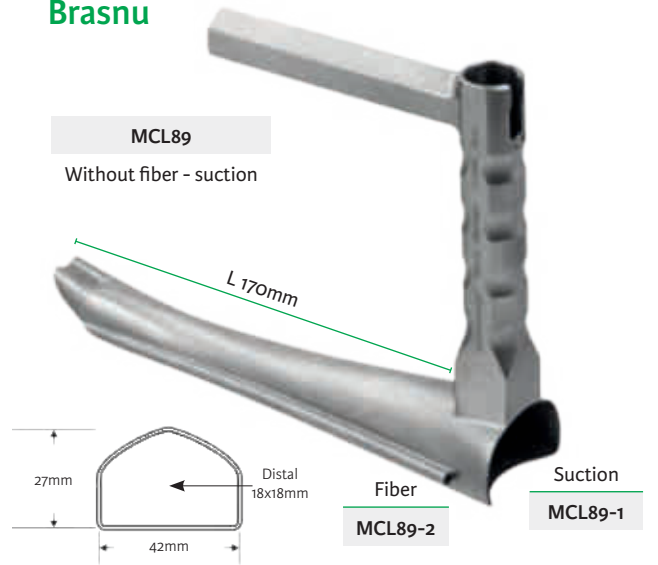

Abitbol

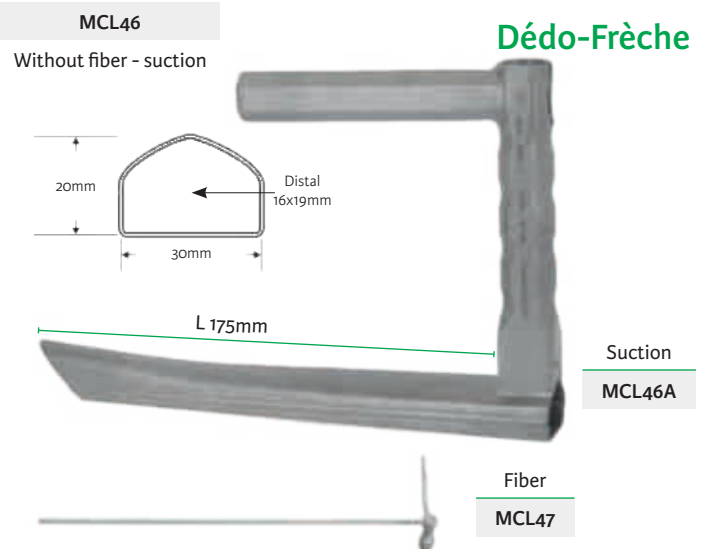
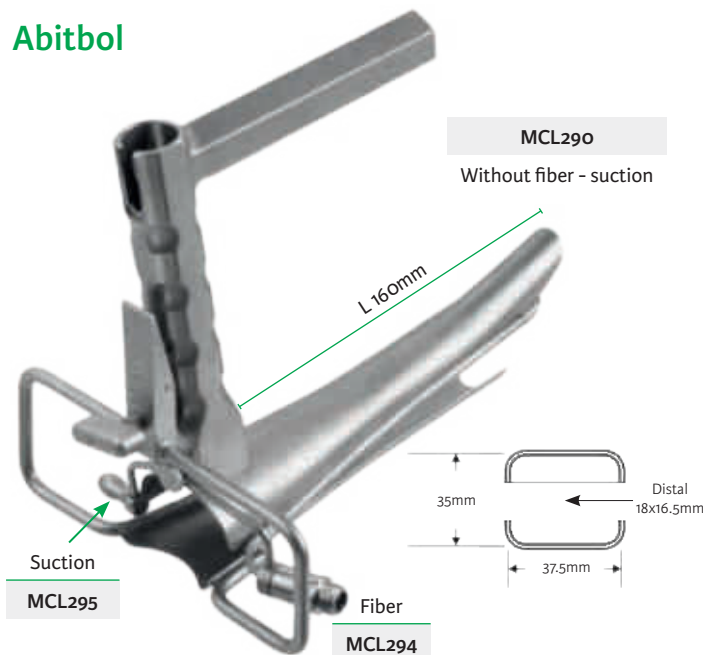

Scale 1/3

Sataloff

Working length - «L»

MCL120

Pediatric size
With fiber and suction

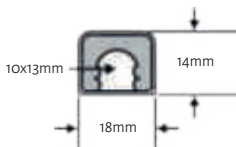

MCL121

Medium male size
With fiber and suction

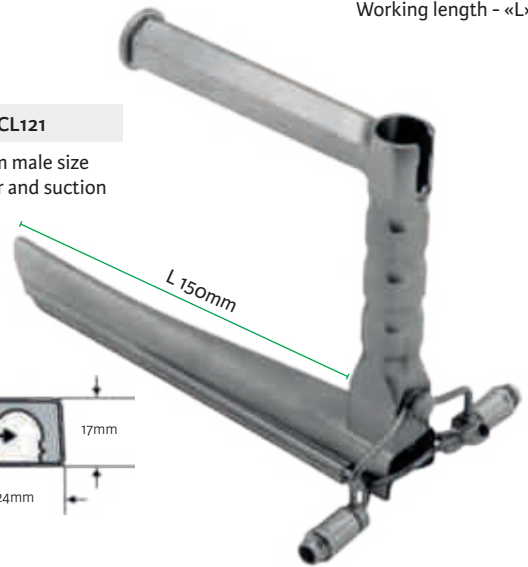
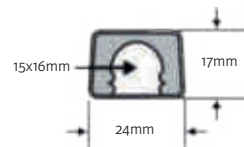

MCL122

Adult size
With fiber and suction

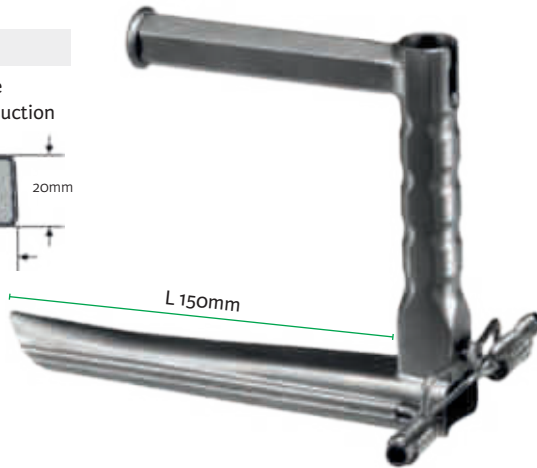
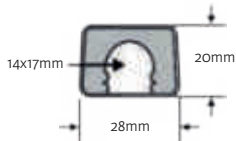

MCL123

Medium female size
With fiber and suction

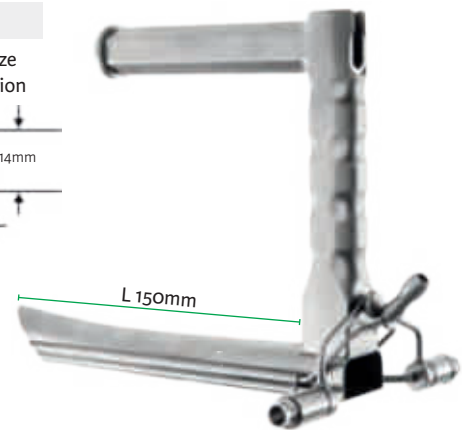
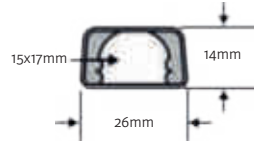

MCL124

«Vallecula»
With fiber and suction

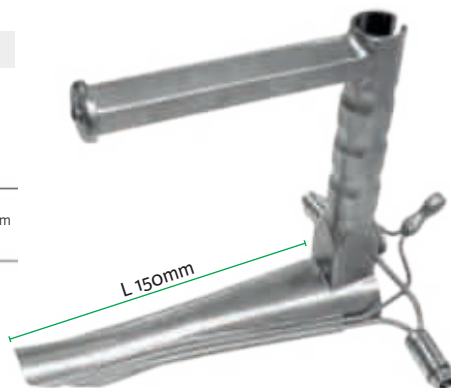
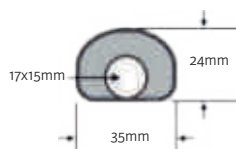

MCL125

With fiber and suction

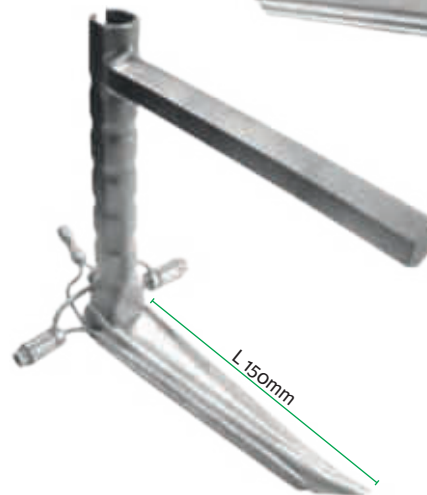
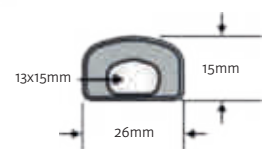

Complete laryngoscope	Right light fiber	Left light fiber	Dual suction tube
MCL120	MCLS120-2	MCLS120-1	MCLS120-3
MCL121	MCLS121-2	MCLS121-1	MCLS121-3
MCL122	MCLS122-2	MCLS122-1	MCLS122-3
MCL123	MCLS123-2	MCLS123-1	MCLS1233
MCL124	MCL124FR	MCL124FL	MCL124ST
MCL125	MCL125FR	MCL125FL	MCL125ST

Suction tube

Bouchayer



MCL10
Ø 2.5mm

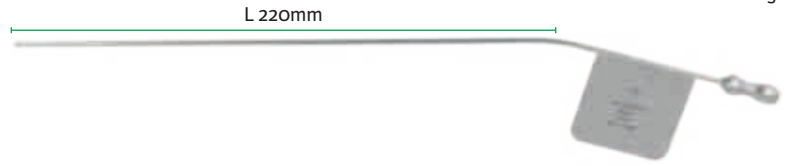

Blunt eyes suction tube

Brasnu



MCL100
Ø 2.5mm

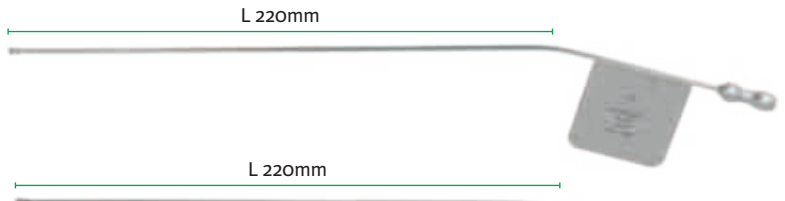

Garabédian



MCL100T20 MCL100T15
Ø 2mm Ø 1.5mm

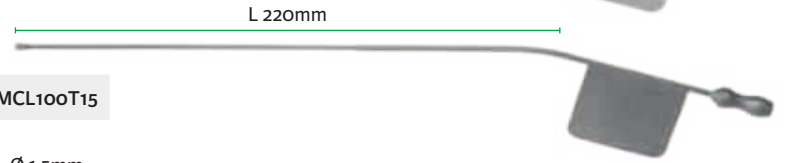

Insulated suction tube

Abitbol



MCL210
Ø 2.5mm

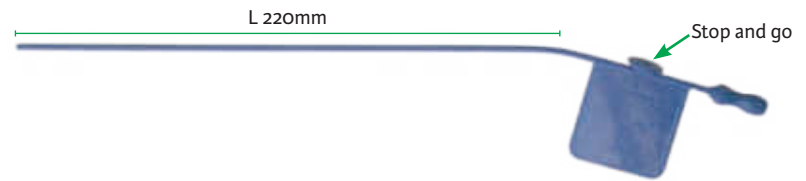

Suction tube with finger control



3734109
Ø 2mm

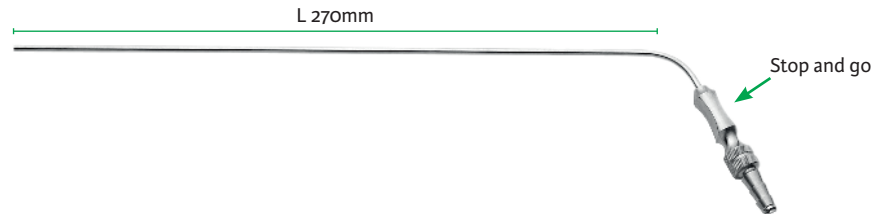

Dual suction tube

Huttenbrink

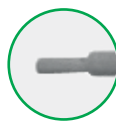

MCL103
Ø 2.5mm



French velvet eye suction tube

Sataloff



Micro suction tube
MCL-S16



Micro suction tube
with retractor below
MCL-S17



Micro suction tube with
retractor above
MCL-S17-1

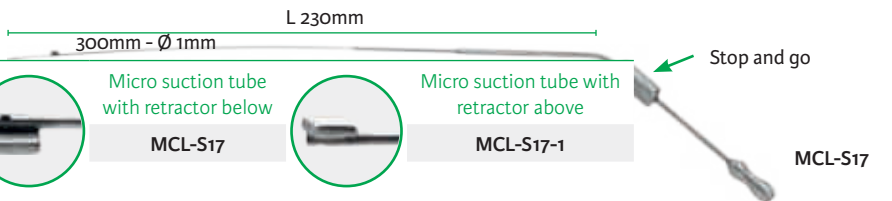

Working length - «L»

Scale 1/3



MCL18 curved right	MCL15 curved left	MCL25 straight
------------------------------	-----------------------------	--------------------------



Alligator forceps

MCL18

Bouchayer

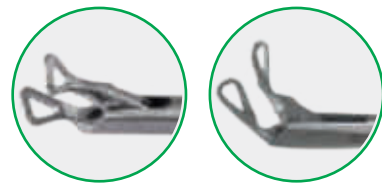

MCL19 left	MCL19BIS right
----------------------	--------------------------

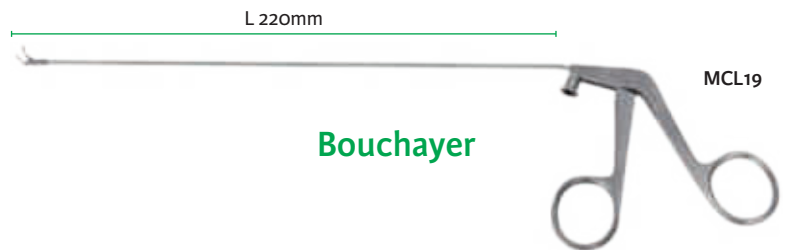

Heart-shaped forceps 45°

MCL19

Bouchayer

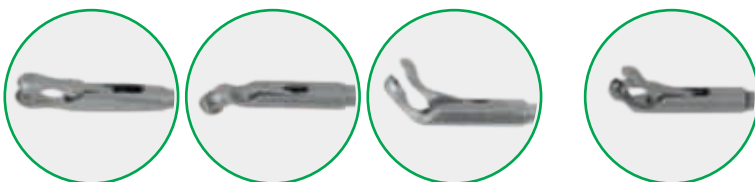

MCL12 straight	MCL29 curved left 45°	MCL30 curved right 45°	MCL33 upward
--------------------------	------------------------------------	-------------------------------------	------------------------

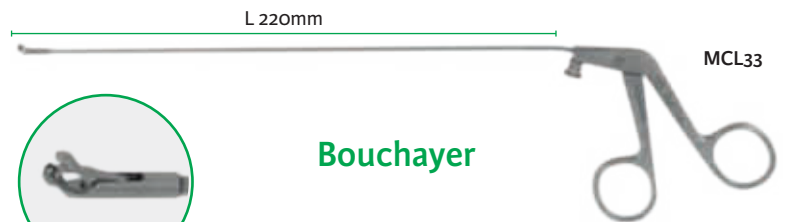

Cup forceps Ø 2mm

MCL33

Bouchayer



MCL67 upward	MCL68 curved left	MCL69 curved right
------------------------	-----------------------------	------------------------------

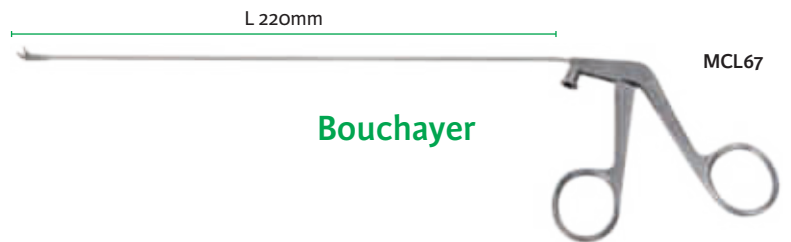

Oval cup forceps

MCL67

Bouchayer

Scale 1/2

Micro scissors

Bouchayer

L 220mm



MCL11
straight



MCL31
angled up - 45°



MCL16
right curved



MCL17
left curved



MCL11

Lancet knife, elevator

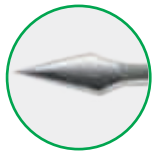

Lancet knife

MCL57



Angled elevator 90°

MCL81BL

left



MCL81BR

right



Elevator

MCL56BL

curved left



MCL56BR

curved right

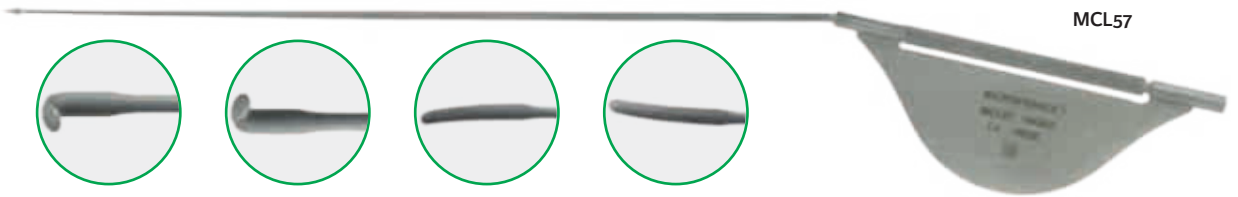

MCL57

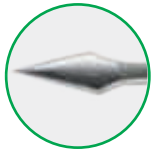

Lancet knife handle and 3 blades

MCL93

knife blades (pk 3) for MCL93

MCL93-2



MCL93

Micro needle-holder



MCL94

straight serrated jaws
1.5x5mm



Micro retractor forceps



MCL82



Scale 1/2

L 220mm

Elevator



Micro elevator, angled 90°

Micro elevator curved

MCL81PL	MCL81PR	MCL56PL	MCL56PR
left	right	left	right



Lancet knife



Blade spear, sterile, disposable



1458234
Pack 5

MCL92-1
Blade holder for 1458234

Stylet handle and needle-holder insert

Scale 1/3

Micro needle-holder handle and insert

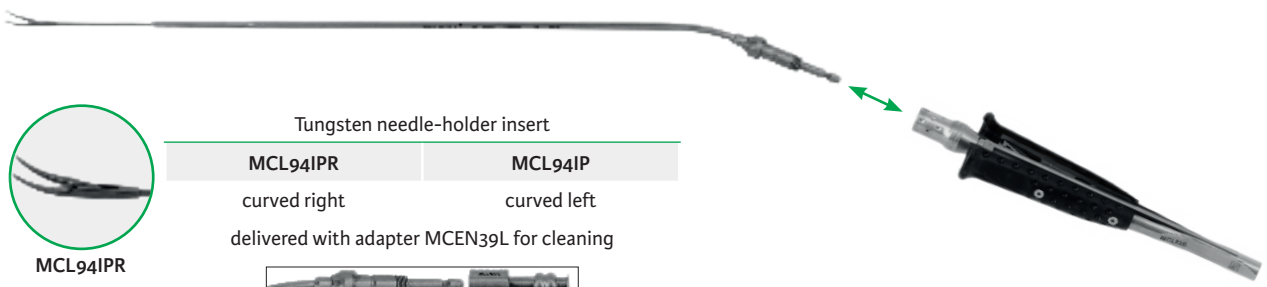

Tungsten needle-holder insert

MCL94IPR	MCL94IP
curved right	curved left

delivered with adapter MCEN39L for cleaning

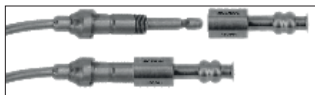

MCL94IPR

Stylet handle without ratchet

MCL828



MCEN39L

Luer-lock adapter for tube insert cleaning port
Pack 3

Scale 1/3
Working length - «L»

Insulated suction tube with finger control



MCL210
Ø 2.5mm

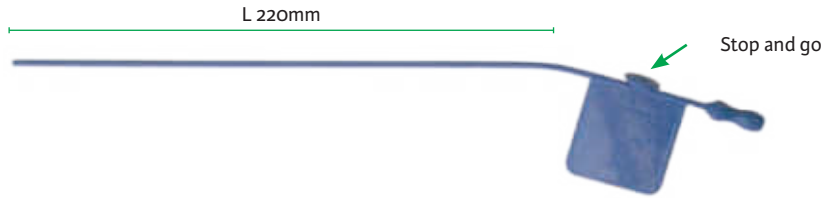

Monopolar fenestrated forceps



MCL205
3x9mm jaws



Heart-shaped forceps, monopolar



MCL219
right curved



MCL219-1
left curved

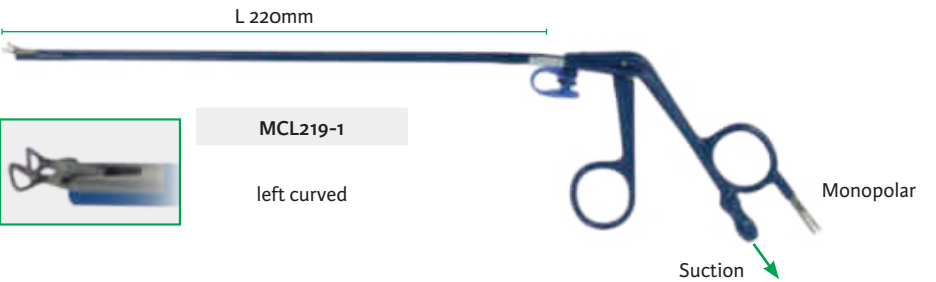

Alligator forceps, monopolar



MCL241
right curved



MCL241-1
left curved

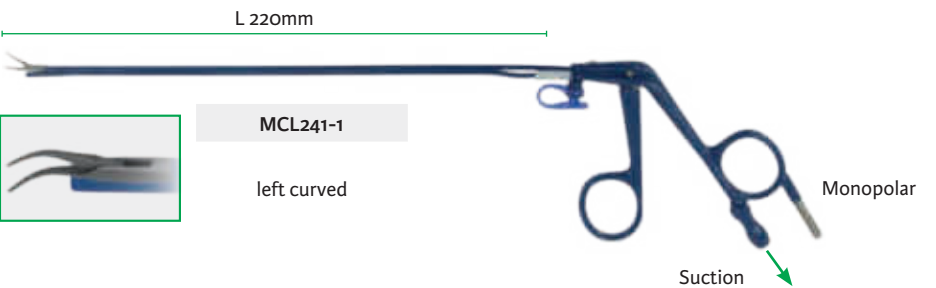

Monopolar cables - 3.5 m



CP391E

Erbe ACC ICC/VIO Storz Wolf



CP391M

Aesculap Berchtold Lamidey Martin Erbe T Serie Sutter BM-780 II



CP391V

Bowa Bovie Conmed Valleylab

Scale 1/2 Working length - «L»

Knife blade sterile, Single use, Pack 25
Scale 2/3



Laryngeal diastema - pediatrics

CP821E

Scalpel handle 170mm

Scalpel handle, knife blade

Garabédian

Scale 1/3

L 180mm

Micro pediatric needle-holder
handle and insert

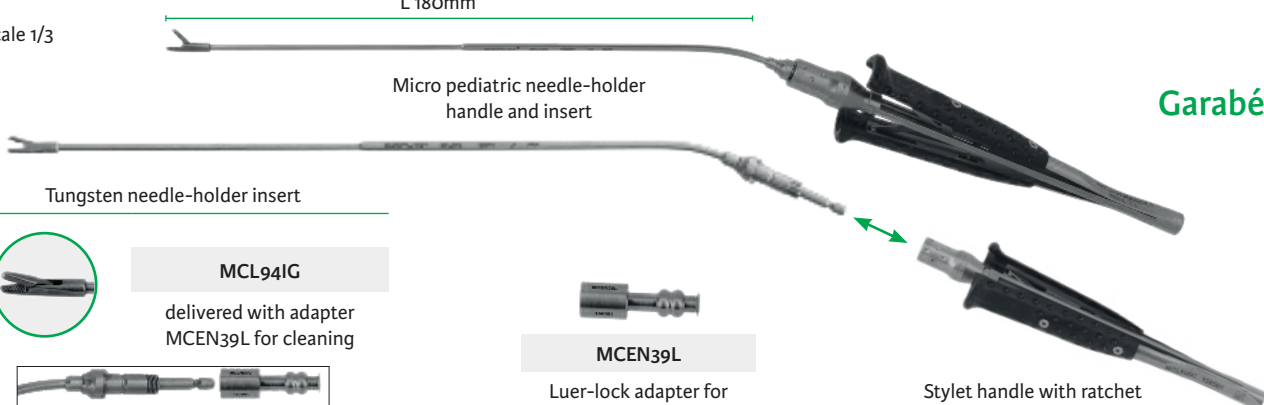

Tungsten needle-holder insert



MCL94IG

delivered with adapter
MCEN39L for cleaning



MCEN39L

Luer-lock adapter for
tube insert cleaning port
Pack 3

Stylet handle with ratchet

MCL828C

Needle-holder

Garabédian

Scale 1/2

L 230mm

Needle-holder, tungsten jaws



MCL94G

1-piece

Cleaning
instrument

Garabédian

Oval knife, hook, retractor

Scale 1/2

L 220mm



MCL4

oval knife 3x4mm



MCL5

oval knife 45° 2mm



MCL7

blunt hook



MCL48

blunt retractor 7mm

Micro sickle knife

Scale 1/2

Micro sickle knife curved 10mm

L 220mm



MCL1BIS

^(D) Distributed by Integra MicroFrance SAS (France) - For corresponding manufacturer part numbers, see table in annex

Parsons

Laryngeal sprinkler

L 200mm

Scale 1/2
Working length - «L»



MCL98

Ø 1,5mm

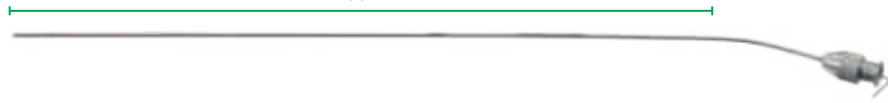

Bouchayer

Bayonet injection needle

L 210mm



MCL58

Ø 0,5mm

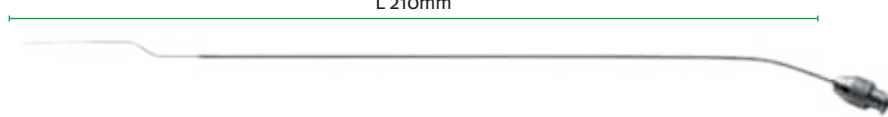

Woo

Scissors, 5mm blades

L 200mm



MCLW10

straight

MCLW11

up 45°

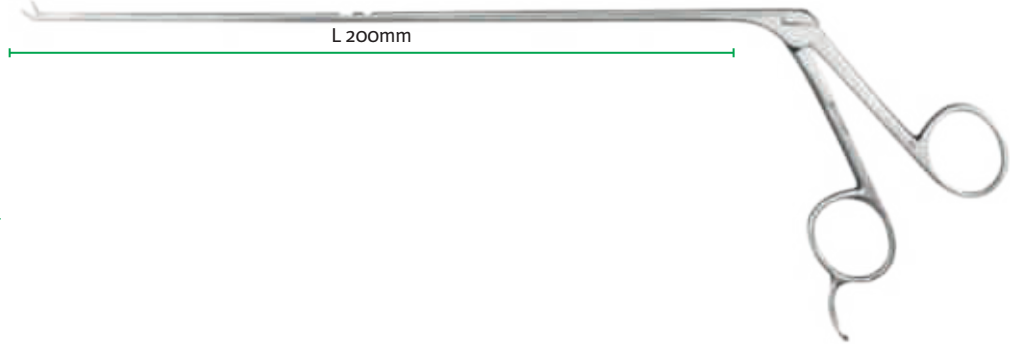

3734115

knife

L 250mm



Lowinger

Double probe

MCL101

Ø 2,5mm / 1mm
280mm

MCL102

Ø 2mm / 1mm
260mm

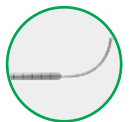

Blitzer

Knife blade, sterile, Single use
Pack 5

1422300

sickle tip



L 250mm

Scale 1/3

Working length - «L»

Monopolar instruments

Frèche

Electrode pick bayonet

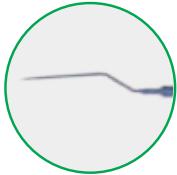

MCL59

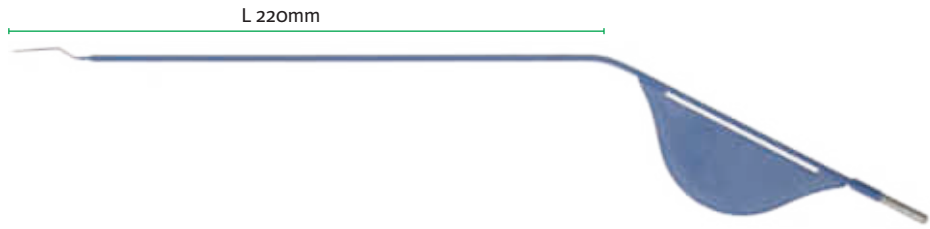

Suction tube with finger control

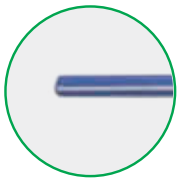

MCL62

Ø 2.5mm



Monopolar cables - 3.5 m



CP391E

Erbe ACC ICC/VIO Storz Wolf



CP391M

Aesculap Berchtold Lamidey Martin Erbe T Serie Sutter BM-780 II



CP391V

Bowa Bovie Conmed Valleylab

Bipolar forceps

Micro forceps, straight jaws



MCL34



Delivered with box and tray

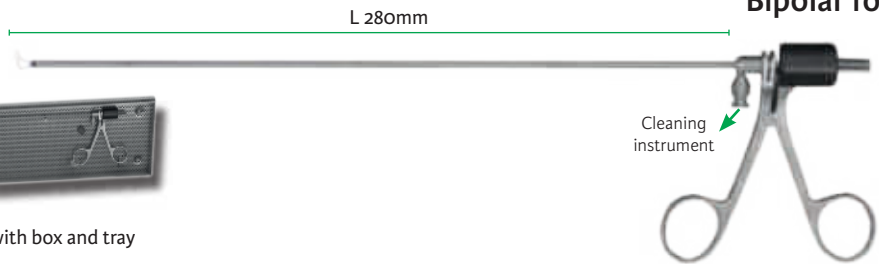

Peretti

Micro forceps, angled jaws



MCL340

Jaws 45° - 2mm

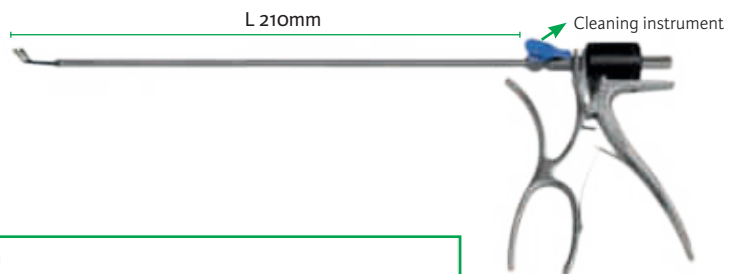

Bipolar cables - 4.5 m



CP393-2

Bowa Emc Lamidey Valleylab



CP393-3

Storz Wolf Erbe (except ICC/VIO international)



CP393-4

Aesculap Berchtold Martin Sutter BM-780 II

Injector, injection needles

Bouchayer

Injection needle bayonet tip Ø 1mm



MCL55-1



MCL55-2

right



MCL55-3

left

Injection needle, straight malleable Ø 0.5mm



MCL55U

Pk 6 - Single use non sterile



L 220mm



MCL55-1

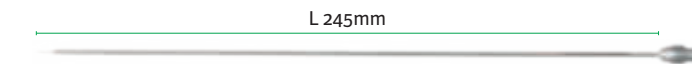

L 245mm

MCL55U

Scale 1/3

Working length - «L»

Injector

MCL55

with needle MCL55-1

MCL55B

with adapter MCL55R

Luer-lock adapter



MCL55R

Scale 1/1

Oro-tracheal injector

Injection needle Ø 0.4mm
Oro-tracheal
Sterile, disposable - Pack 5

1650050

L 8mm



Scale 2/1

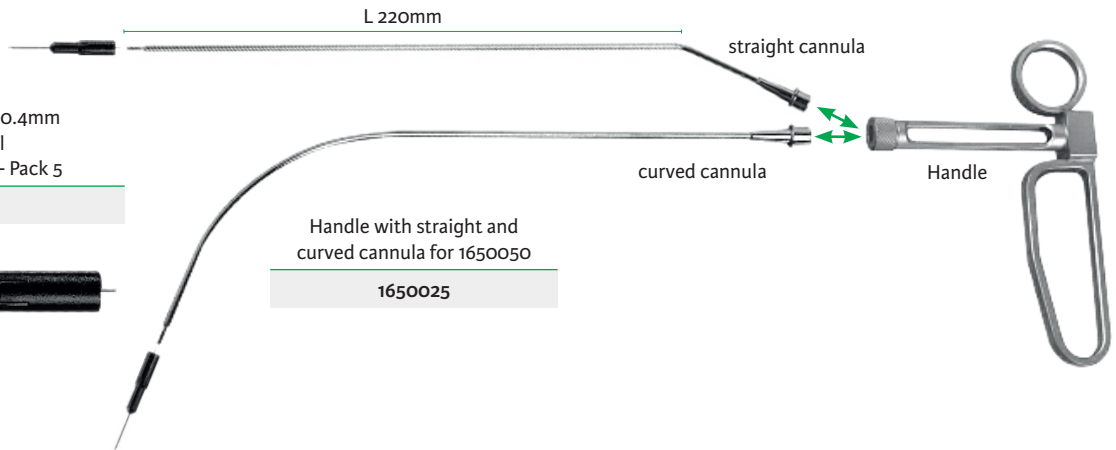

L 220mm

straight cannula

curved cannula

Handle

Handle with straight and curved cannula for 1650050

1650025

Transcervical laryngeal injection

Casiano

MCL55T6

MCL55T4

MCL55T5

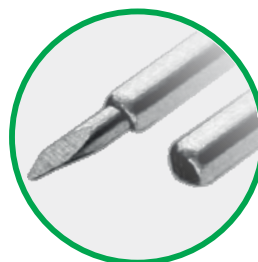

Handle for injection needle

MCL55T4

Trocar obturator

MCL55T6

Injection needle
Ø 0.8mm L 40mm - Pack 6

MCL55T5

non sterile

Straight injection needle - 80 mm Ø 0.4 mm
MCL-S4
 Pack 6

Curved injection needle - 80 mm Ø 0.4 mm
MCL-S5
 Pack 6

Luer-lock adapter, straight 165mm
MCL-S0

Luer-lock adapter angled 50 mm
MCL-S27

Scale 1/3
 Working length - «L»
 Injection needle straight 90mm Ø 1.3mm
MCL-S35

Dismantled instruments for instrument holder MCL-S19

MCL-S15
MCL-S7
 L 220mm

MCL-S19
 instrument holder

Micro knife L 220mm
MCL-S6 straight sickle 7mm Pack 6
MCL-S20 vascular 2mm
MCL-S25 curved sickle 6mm Pack 6
MCL-S9 sharp 90° 2mm
MCL-S26 flap 90° 3mm

Micro knife L 250mm
MCL-S11 45° Ø 3mm
MCL-S12 90° Ø 2.5mm
MCL-S13 90° Ø 3mm

Micro ball dissector L 220mm
MCL-S8 angled 8mm 20°
MCL-S1 curved 1x9mm
MCL-S7 straight 1x10mm

Micro spatula L 220mm

Instruments L 220mm					L 250mm	
Hook	Mirror	Ball dissector	Cotton carrier	Curved curette for cyst		Mirror
MCL-S2	MCL-S14	MCL-S10	MCL-S3	MCL-S38		MCL-S15
2 prongs, sharp	70° - Ø 3mm		19mm	Ø 1mm		70° - Ø 4mm

Dismantled instruments

Micro knife sterile, single use - L 220mm - Pack 6

MCL-S33
 curved sickle knife 6mm

Thyroplasty elevator and knife

knife Ø 2.5mm **3711099** Elevator markings 1 to 8
 Micro double instrument 195mm

Scale 2/3
Working length - «L»

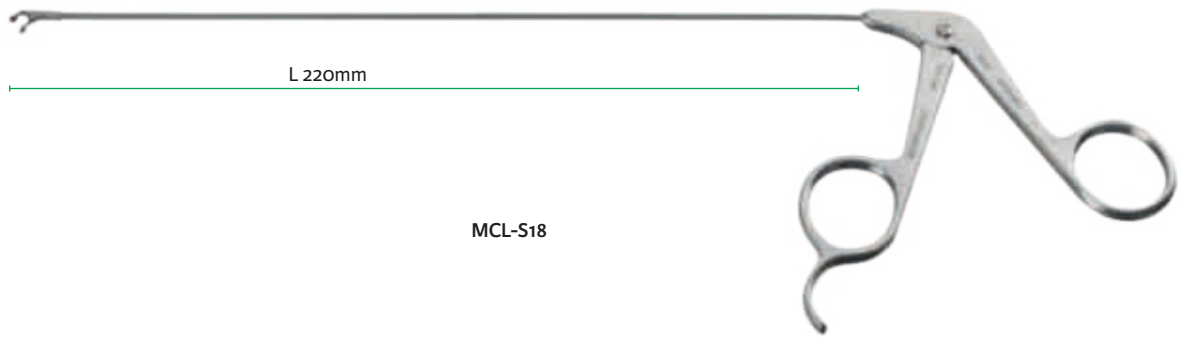

MCL-S18

Cup forceps	Heart-shaped grasper	
MCL-S18	MCL-S21	MCL-S22
downbiting	right	left

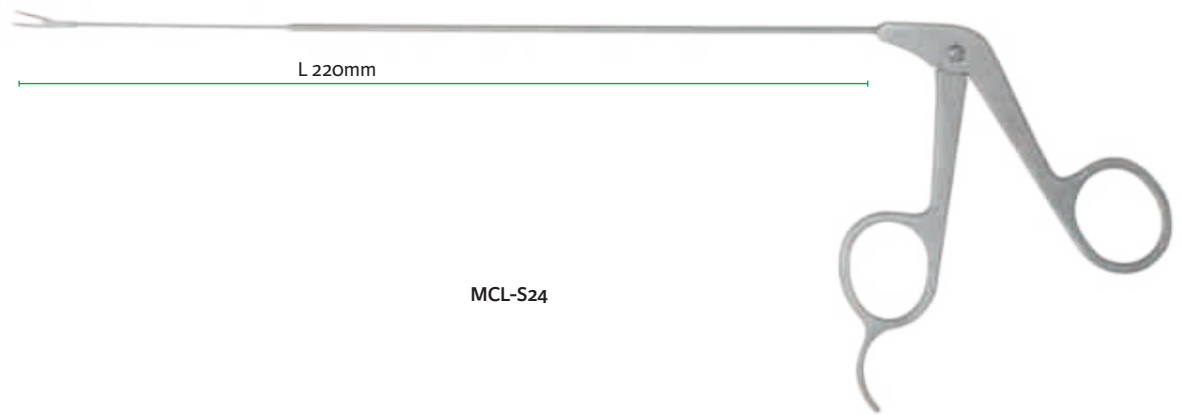

MCL-S24

Alligator forceps			
MCL-S23	MCL-S24	MCL-S39	MCL-S41
right	left	fine right jaws	fine left jaws

Scale 1/3
Working length - «L»

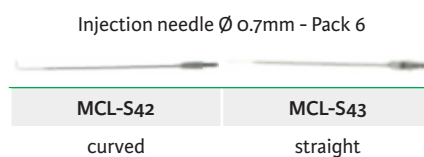
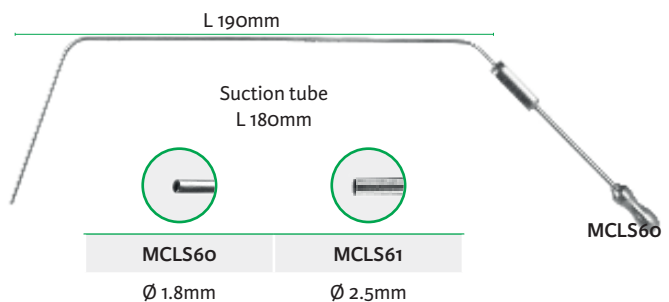
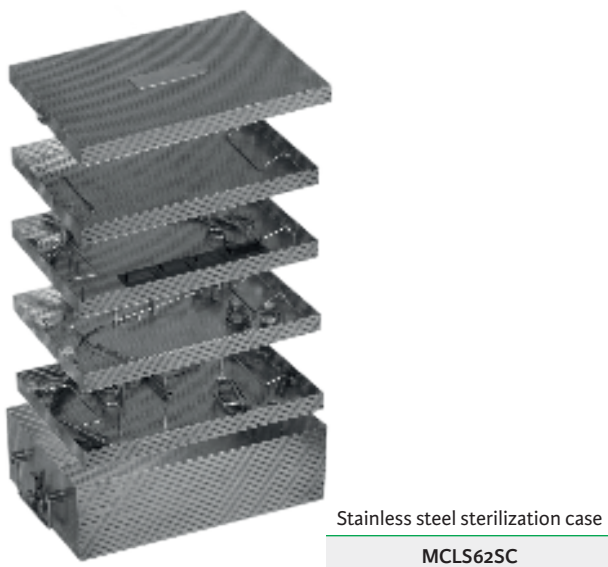
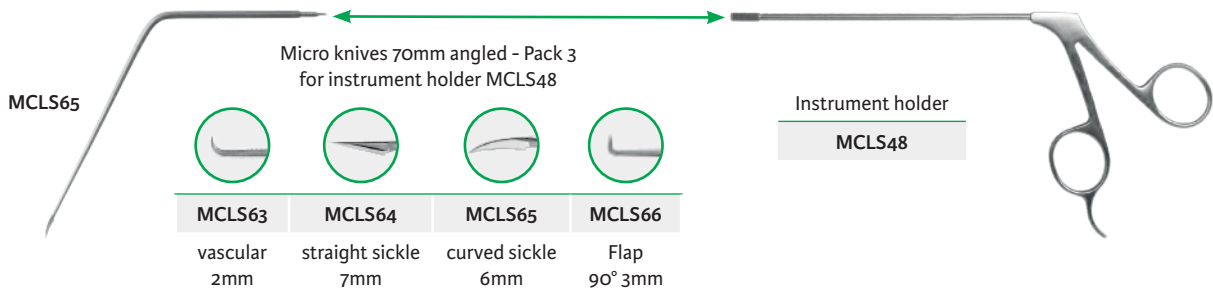
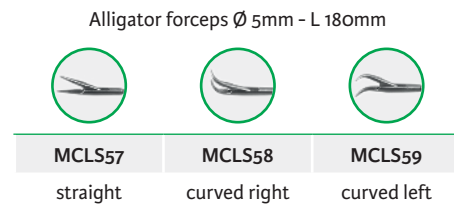
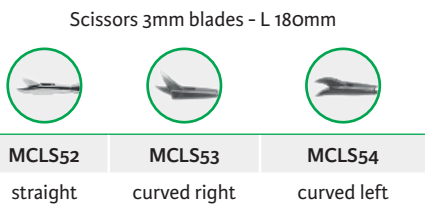
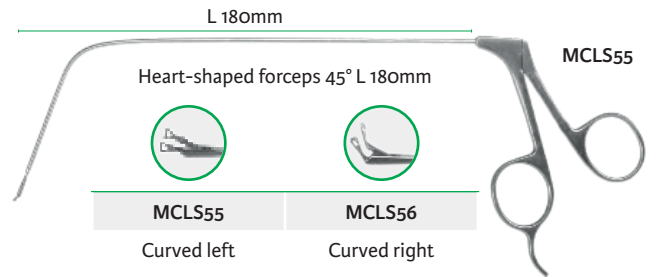
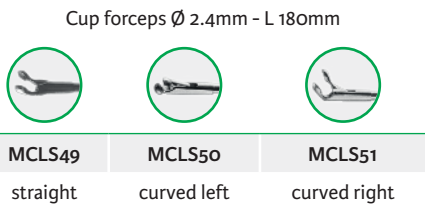
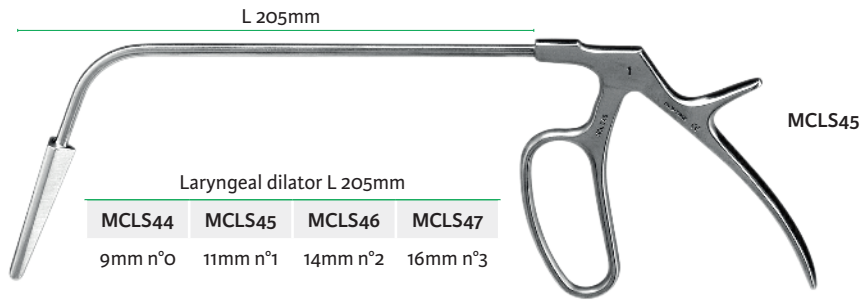

Scale 1/3

Working length 220mm



Micro scissors



MCLB16

curved right



MCLB17

curved left



MCLB31

angled 70°



MCLB31

Cup forceps



MCLS18R

280mm

downbiting



Heart-shaped grasper



MCL-S21R

right



MCL-S22R

left



MCL-S23R

right

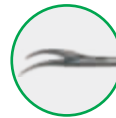

MCL-S24R

left



MCL-S22R

Needle-driver



MCLB94

280mm

angled up 70°



Suture knot pusher



MCLB30

250mm



Working length - «L»

Scale 1/3

L 255mm

Micro scissors, 5mm blades		Mini forceps, 9mm serrated jaws	
	3733002 straight	3733003 up 45°	3731020 angled up

3733002 **3733002**

Cleaning instrument

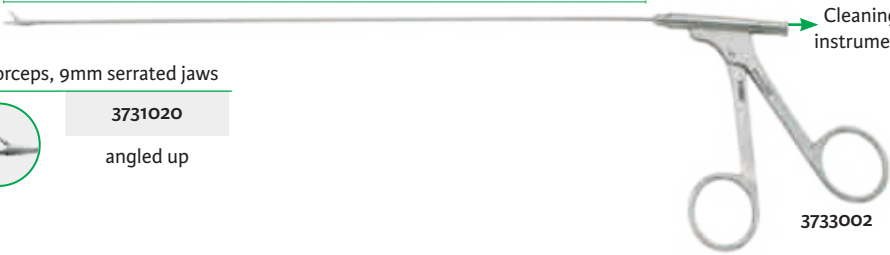

Cup forceps Ø 1mm - L 250mm		Cup forceps Ø 2mm				
	3731011 straight	3731022 angled up	3731023 right	3731024 left	3731025 curved right 45°	3731026 curved left 45°

3731011 **3731022**

Cleaning instrument

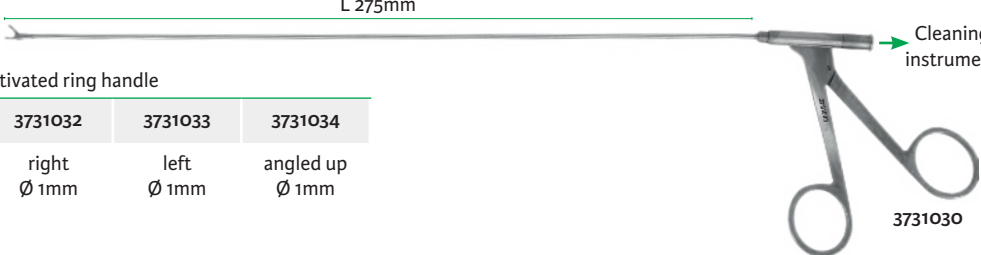

L 275mm

Cup forceps, thumb activated ring handle					
	3731030 straight Ø 1mm	3731031 straight Ø 2mm	3731032 right Ø 1mm	3731033 left Ø 1mm	3731034 angled up Ø 1mm

3731034 **3731030**

Cleaning instrument

L 275mm

Micro forceps, serrated jaws, thumb activated ring handle			
	3731035 straight	3731036 right	3731037 left

3731036 **3731035**

Cleaning instrument

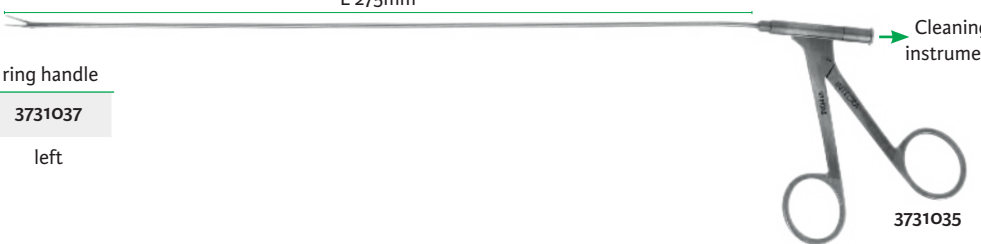

L 275mm

Micro scissors, 4mm blades, thumb activated ring handle				
	3733007 straight vertical opening	3733008 left	3733009 right	3733010 angled up 45°

3733007 **3733007**

Cleaning instrument

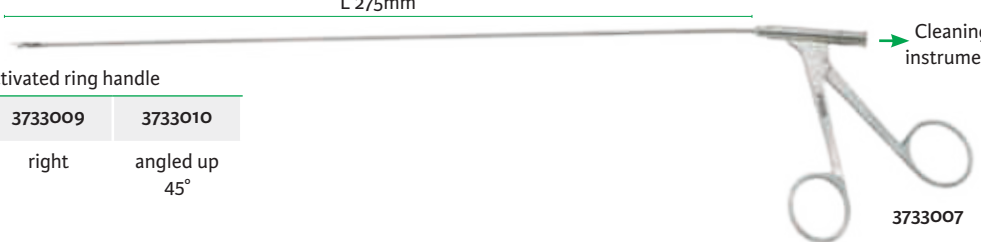

Working length - «L»

Scale 1/3

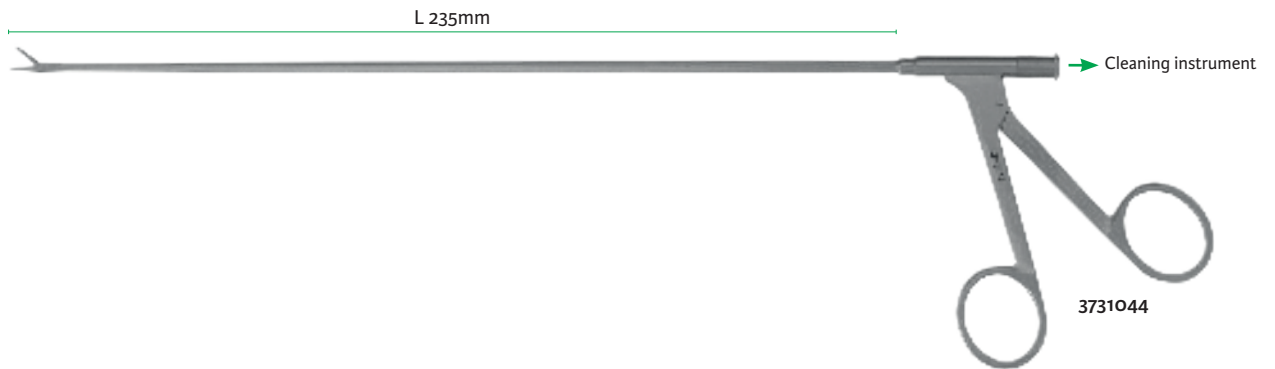

Micro forceps, serrated jaws 9mm, thumb activated ring handle

	3731042	3731043	3731044	3731045
3731044	straight	up	right	left

Micro cup forceps, Ø 2mm jaws, thumb activated ring handle

	3731038	3731039	3731040	3731041
3731041	straight	left	right	upward

Micro scissors, 4 mm blades, thumb activated ring handle

	3733014	3733016	3733017	3733018
3733018	straight vertical opening	left curved	right curved	angled up

Scale 1/2
Working length «L»



Trocar holder ring
Ø 10mm

MCLP70

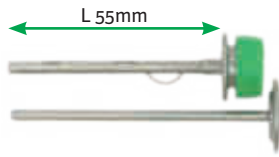

Trocar
with blunt tip

MCLP10

L 55mm

L 180mm

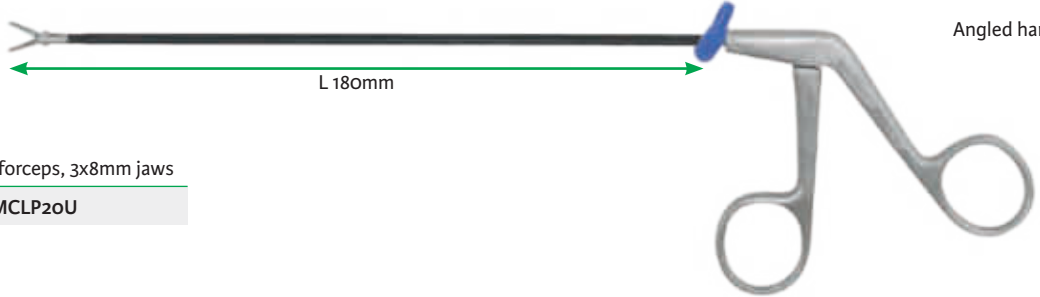

Angled handle



Fenestrated forceps, 3x8mm jaws

MCLP20U



Fenestrated forceps, 3x8mm jaws

MCLP25U

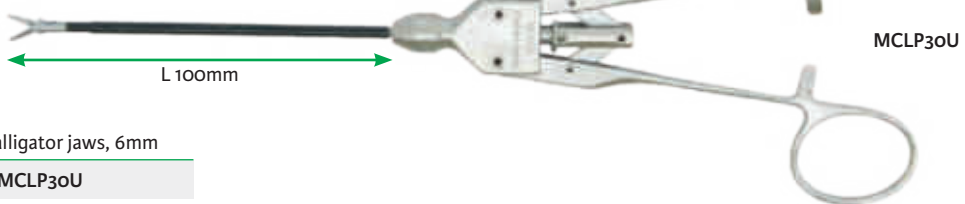

MCLP30U

Axial handle

L 100mm



forceps, alligator jaws, 6mm

MCLP30U



Micro scissors, 4mm blades

MCLP40U



MCLP40U

Axial handle

L 100mm



Monopolar hook

MCLP50



MCLP50

L 100mm





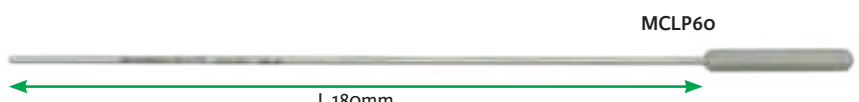

Round palpation probe

MCLP60



MCLP60

L 180mm

		Blunt retractor 180mm
MCLT10	small tips : 8x35 / 15x40mm	
MCLT11	Large tips : 8x35 / 15x50mm	
		Blunt curved elevator 190mm
MCLT20	2mm	
MCLT21	4mm	
		Suction tube elevator 200mm Ø 3mm
MCLT40	Malleable	
		Nerve eye suction tube with finger control 200mm Ø 3mm
MCLT50	Malleable	
		Peanut holder 200mm Ø 3mm axial handle
MCLT30		

Robotic thyroid surgery

MCLT12R	Muscle retractor	
MCLT13R	Bivalve retractor	
MCLT21R	Ball hook elevator Ø 4mm 440mm	
MCLT40R	Suction elevator, malleable, Ø 3mm 270mm	
MCLT50R	Malleable ner eye suction tube, 330mm	

not shown

Trocar with metal cannula











Scale 1/1

			Working length	
			50 mm	80 mm
Trocar tip	smooth		CEV8143A4	CEV143A4
	pyramidal		CEV8143A3	CEV143A3
Sealing cap	green		CEV103P6 Pack 6	
Trocar head	magnetic		CEV177A3 Delivered complete with 1 magnetic valve and 1 green sealing cap	
	silicone		CEV127T3 Delivered complete with 1 silicone valve and 1 green sealing cap	
Valve for trocar head	magnetic		CEV179A5 Pack 6	
	silicone		CEV125P6 Pack 6	
Metal cannula, crenelated	with stopcock		CEV8143A7	CEV143A7
	without stopcock		CEV8143B7	CEV143B7

Composite trocar with silicone valve



			Working length	
			45 mm	70 mm
Trocar tip 	smooth 		CEV8826M (1)	CEV326M (1)
	pyramidal 		CEV8826P (1)	CEV326P (1)
Sealing cap	green 		CEV103P6 Pack 6	
Valve for trocar head	silicone 		CEV125P6 Pack 6	
Trocar body composed of 1 trocar head with composite cannula and silicone valve	smooth cannula without stopcock		CEV8826L (1)	
				CEV326L (1)
	threaded cannula without stopcock		CEV8826V (1)	
				CEV326V (1)

(1) New reference

Monopolar hook





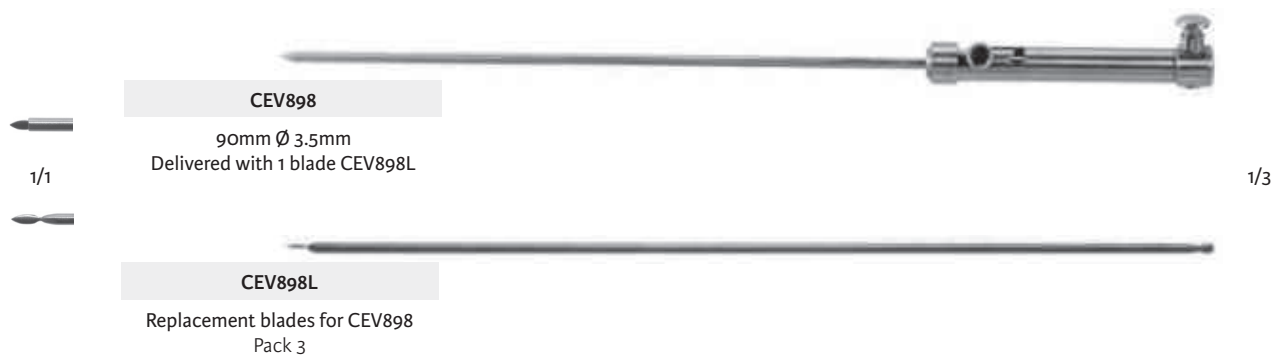



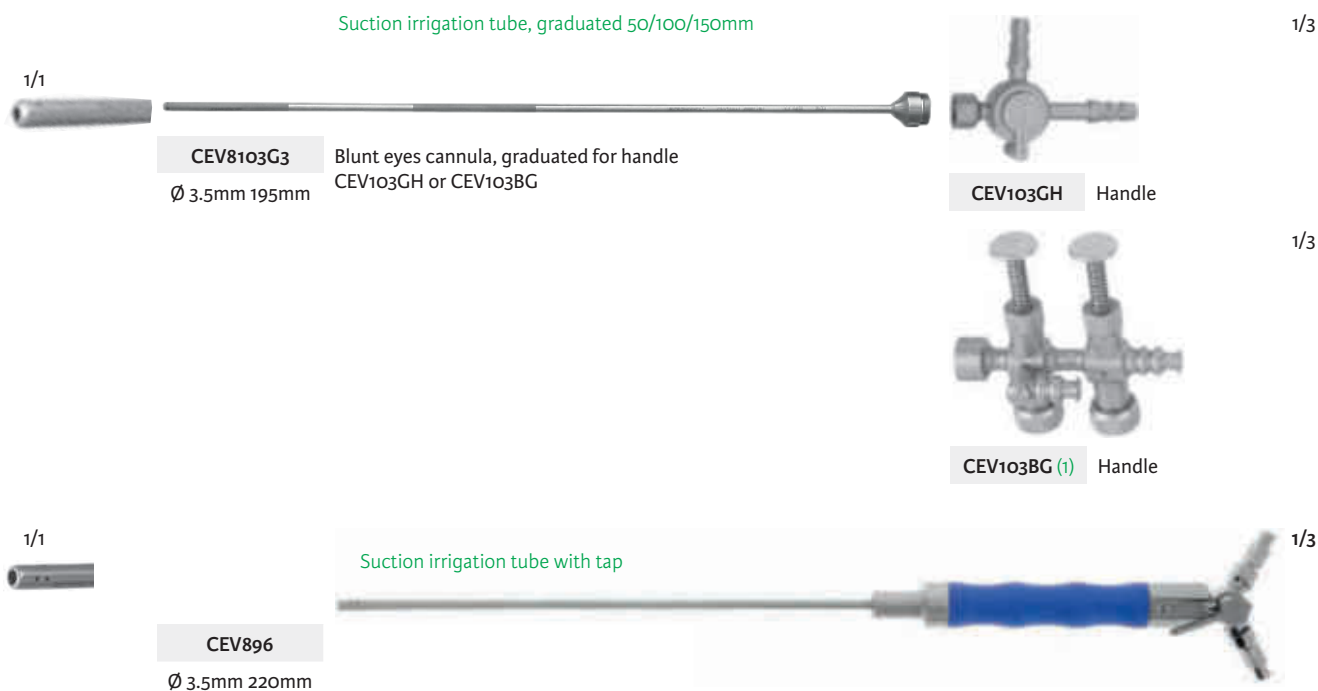



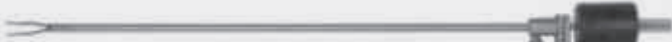

Retractable knife















Suction irrigation tube



(1) New reference

1-piece			
Complete instruments : bipolar forceps			
Jaws Scale 1/1		Handle	Working length
 serrated jaws, 1,5mm		Angled, bipolar	CEV897 250 mm
			1/3
 fenestrated jaws, 10x3mm		«K» handle, bipolar	CEV897BG 250 mm
			1/3
 spatula jaws, 2mm		«K» handle, bipolar	CEV897C 250 mm
			1/3









Bipolar cables - 4.5 m		
		
CP393-2	CP393-3	CP393-4
Bowa Emc Lamidey Valleylab	Storz Wolf Erbe (except ICC/VIO international)	Aesculap Berchtold Martin Sutter BM-780 II

Semi-Modular		
Inserts with tubes		Handle
Jaws with insulated tube Scale 1/1	Working length	Pages
 Babcock insert	CEV891I 235 mm	   Rotatable page 88 - 89
 Curved scissors insert serrated blades 8mm	CEV893I 230 mm	
 Straight scissors insert serrated blades 8mm	CEV894I 230 mm	
 Fenestrated insert 3x12mm jaws	CEV895I 235 mm	
 Grasping insert	CEV899I 220 mm <i>New reference</i>	
 Alligator jaws insert 6mm	CEV896I 235 mm	
 Dissector insert medium curved 10mm jaws	CEV898I 230 mm	
	CEV39L Adapter cleaning luer-lock for tube insert	

Modular

Rotatable instruments

Angled handles with black rotatable ring
Scale 1/3

 <p>with ratchet</p>	<p>CEV1019T5BU Large pattern</p>  <p>with ratchet</p> <p>CEV10195CU</p>
 <p>with ratchet</p>	<p>CEV10195DU</p>  <p>with ratchet</p> <p>CEV10195RU</p>
 <p>without ratchet</p>	<p>CEV1039T5TBU Large pattern</p>  <p>without ratchet</p> <p>CEV10395DU</p>
 <p>without ratchet</p>	<p>CEV10395RU</p>  <p>without ratchet</p> <p>CEV1039G5U</p>

Modular

Rotatable instruments

Axial handles with black rotatable ring
Scale 1/3



with ratchet

CEV6285R



without ratchet

CEV6385RU



with ratchet

CEV628P5



with long ratchet

CEV728T5

Modular

Rotatable instruments

Ergonomic handles with black rotatable ring
Scale 1/3

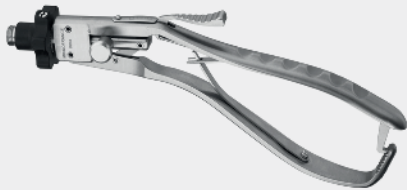

Large ergonomic handle
with ratchet

CEV720BRUC



Fine ergonomic handle
with ratchet

CEV720RU



Elhadad









Fine ergonomic handle
with ratchet









CEV7285RU









Large ergonomic handle
with ratchet

CEV728BR5U

1-piece		
Complete instruments		
Jaws Scale 1/1	Handle	Working length
 Montupet Babcock forceps	 Angled with long ratchet	CEV891MU 200 mm
 Montupet Straight scissors serrated blades 8mm	 Angled	CEV894MU 220 mm
 Montupet Fenestrated forceps 3x12mm jaws	 Angled with long ratchet	CEV895MU 195 mm
 Grasping forceps with teeth	 Angled with long ratchet	CEV899U 220 mm New reference

1-piece			
De Lagausie instruments			
Jaws Scale 1/1	Handle		Working length
 De Lagausie Fenestrated forceps 3x12mm jaws	 Axial		CEV995MU 220 mm
 De Lagausie Straight scissors serrated blades 8mm	 Axial		CEV996MU 220 mm
 De Lagausie Alligator forceps 6mm serrated jaws	 Axial		CEV997MU 210 mm
 De Lagausie Dissector medium curved 10mm	 Axial		CEV998MU 220 mm

Needle-holder			
 Montupet Needle-holder straight tungsten jaws	 Angled with long ratchet		CEV892 220 mm
 Reinberg Needle-holder straight tungsten jaws	 Axial		CEV992 220 mm
 Needle-holder left curved tungsten jaws	 Axial		CEV992D 220 mm

Cup



7876-60^(D)

Cup

7876-60 ^(D)	60mm
7876-80 ^(D)	80mm
7876-100 ^(D)	100mm
7876-120 ^(D)	120mm
7876-160 ^(D)	160mm

Stainless steel tray



7872-24^(D)
Scale 1/2

Stainless steel tray

7872-24 ^(D)	240x180mm
------------------------	-----------

Surgical instrument paraffin oil



Surgical instrument
paraffin oil

MCO731 ^(D)

^(D) Distributed by Integra MicroFrance SAS (France) - For corresponding manufacturer part numbers, see table in annex

Scale 1/5

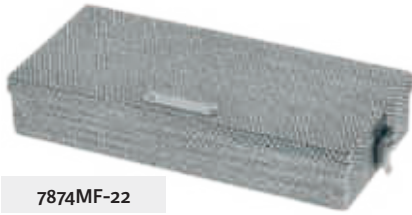

7874MF-22

220x100x40mm

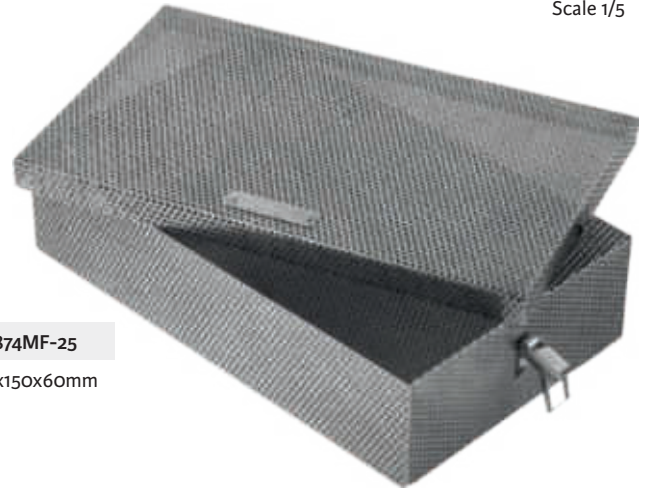

7874MF-25

250x150x60mm

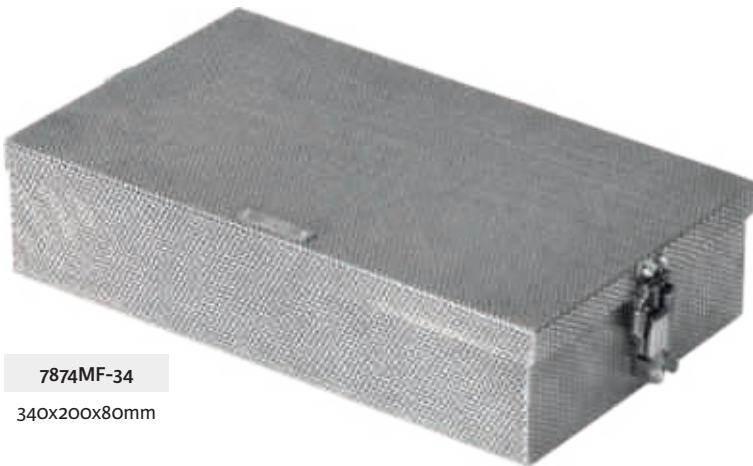

7874MF-34

340x200x80mm



7874MF-40

400x200x90mm

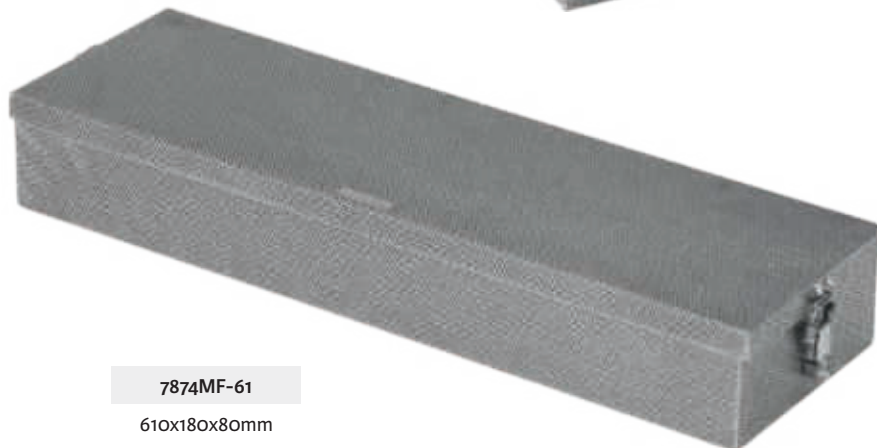

7874MF-61

610x180x80mm

Picture for information, without scale



MCEN136SC
270x160x35mm



3717011
528x250x123mm

Picture for information, without scale



3717001

530x250x140mm

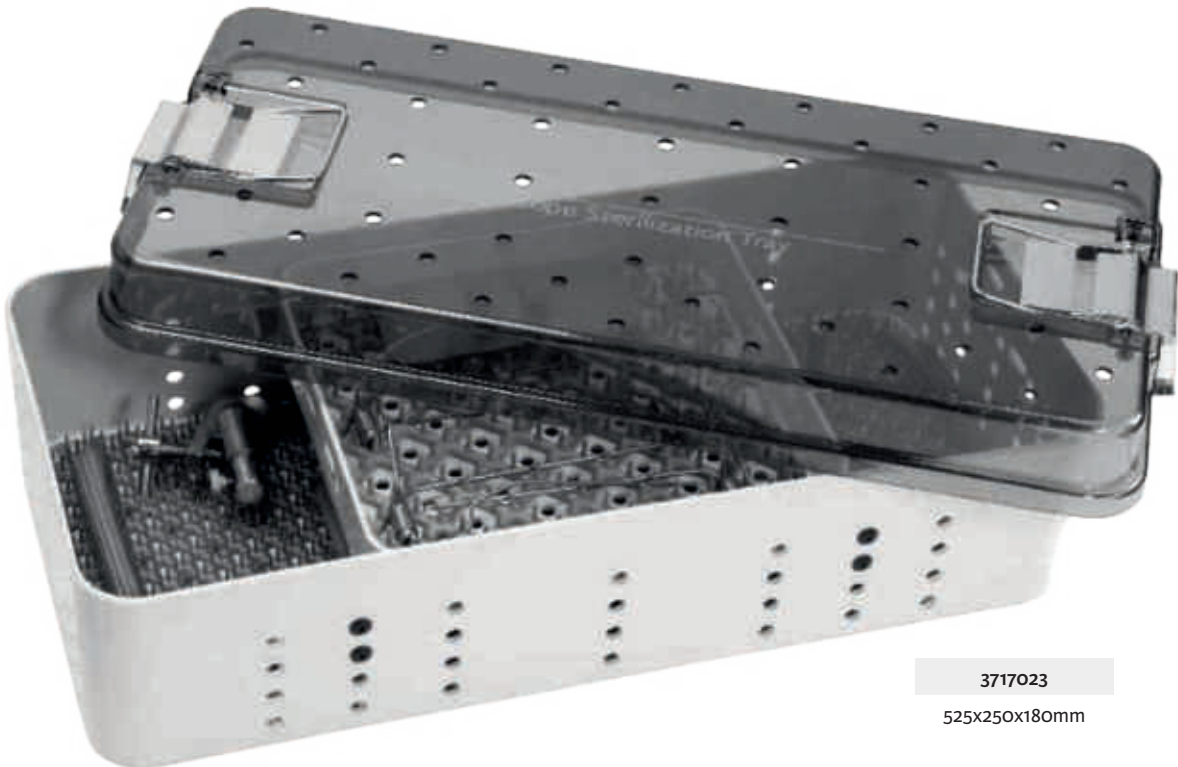

3717023

525x250x180mm

Numerical index

0

0-28-7 29

1

1003IG^(D) 24
 1003LI^(D) 13, 24
 1004IG^(D) 24
 1005I^(D) 24
 1352247 30
 1422300 72
 1423000 16
 1423002 16
 1423004 16
 1458234 69
 1650025 74
 1650050 74

3

3711099 75
 3714027 28
 3714028 28
 3717001 96
 3717011 95
 3717023 96
 3722089 19
 3724059 25
 3724060 25
 3724244 29
 3724247 29
 3731001 18
 3731002 18
 3731003 18
 3731004 12
 3731006 12
 3731007 11
 3731010 12
 3731011 79
 3731020 79
 3731022 79
 3731023 79
 3731024 79
 3731025 79
 3731026 79
 3731030 79
 3731031 79
 3731032 79
 3731033 79
 3731034 79
 3731035 79
 3731036 79

3731037 79
 3731038 80
 3731039 80
 3731040 80
 3731041 80
 3731042 80
 3731043 80
 3731044 80
 3731045 80
 3731052 18
 3731054 12
 3731055 12
 3731056 12
 3731057 12
 3731058 12
 3733002 79
 3733003 79
 3733007 79
 3733008 79
 3733009 79
 3733010 79
 3733014 80
 3733016 80
 3733017 80
 3733018 80
 3734013 16
 3734018 16
 3734038 14
 3734042 14
 3734096 18
 3734097 18
 3734100 18
 3734103 18
 3734104 18
 3734109 66
 3734115 72
 3734155 14
 3734218 59
 3734500 61
 3740012 40
 3740015 43
 3740019 43
 3740028 41
 3740038 41
 3740049 43
 3740067 43
 3740068 20
 3740069 20
 3740071 20
 3740072 20
 3740090 44
 3744027 51
 3755000 56

3755001 56
 3755010 55
 3755100 57
 3755101 53
 3755102 53
 3755106 53
 3755107 53
 3755110 53
 3755111 53
 3755114 54
 3755116 54
 3755117 54
 3755136 54
 3755143 12
 3755147 12
 3755160 56
 3755161 56

7

701T 52
 702T 51
 703T 51
 704T 51
 714T 51
 720T 52
 7755-1-0-4 17
 7755-1-0-5 17
 7755-1-0-6 17
 7768 27
 7768-1 27
 7773 31
 7781 30
 7782-1-2 28
 7787-10 25
 7796 2
 7797-1 10
 7797-2 10
 7798T^(D) 2
 7798T^(D) 2
 7800MF 10
 7802C 3
 7802P 3, 4, 5, 9
 7802S-1 3
 7802S-2 3
 7802S-3 3
 7802S-4 3
 7802S-5 3
 7803B 3
 7803C 3
 7803S-1 3
 7803S-2 3
 7803S-3 3

^(D) Distributed by Integra MicroFrance SAS (France) - For corresponding manufacturer part numbers, see table in annex

7804-9.....	6	7840.....	19	7876-100 ^(D)	93
7804-11.....	6	7843-1.....	59	7876-120 ^(D)	93
7804-13.....	6	7843A-1.....	59	7876-160 ^(D)	93
7805-11.....	6	7844T3L20.....	59	7878.....	13
7805-13.....	6	7844T3L25.....	59	7879.....	13
7808L-1.....	17	7844T3L30.....	59	7884.....	13
7808L-2.....	17	7844T3L35.....	59	7895.....	13
7808L-3.....	17	7844T3L40.....	58	7906.....	13
7808M.....	17	7844T3L45.....	58	7920.....	19
7809MF.....	6	7844T3L50.....	58	7921.....	19
7810.....	17	7844T3L55.....	58	7923.....	32
7811.....	13	7844T3L60.....	58	7945T.....	52
7812.....	13	7844T5L20.....	59	7960T40 ^(D)	-3, 4, 5, 9
7813.....	17	7844T5L25.....	59		
7813-1.....	17	7844T5L30.....	59		
7814.....	13	7844T5L35.....	59		
7814M.....	13	7844T5L40.....	58		
7815.....	13	7844T5L45.....	58		
7819.....	11	7844T5L50.....	58		
7820.....	11	7844T5L55.....	58		
7821A.....	6	7844T5L60.....	58		
7821B.....	6	7844T6L20.....	59		
7822.....	11	7844T6L25.....	59		
7823.....	11	7844T6L30.....	59		
7825.....	11	7844T6L35.....	59		
7826-1-7.....	11	7844T6L40.....	58		
7828-1-10.....	15	7844T6L45.....	58		
7828-1-13.....	15	7844T6L50.....	58		
7828-1-16.....	15	7844T6L55.....	58		
7828-1-19.....	15	7844T6L60.....	58		
7828-10.....	15	7844T74L20.....	59		
7828-13.....	15	7844T74L25.....	59		
7828-16.....	15	7844T74L30.....	59		
7828-19.....	15	7844T74L35.....	59		
7829-10.....	15	7844T74L40.....	58		
7829-13.....	15	7844T74L45.....	58		
7829-16.....	15	7844T74L50.....	58		
7829-19.....	15	7844T74L55.....	58		
7830M.....	19	7844T74L60.....	58		
7831A-12.....	40	7857.....	10		
7831A-15.....	42	7866-13.....	56		
7831A-18.....	44	7867-1.....	53		
7831A-20.....	45	7867-2.....	53		
7832.....	45	7867-3.....	53		
7833A-12.....	40	7867-4.....	53		
7833A-15.....	42	7872-24 ^(D)	93		
7833A-18.....	44	7874MF-22.....	94		
7833A-20.....	45	7874MF-25.....	94		
7834.....	45	7874MF-34.....	9, 94		
7835.....	19	7874MF-40.....	94		
7837-18.....	19	7874MF-61.....	58, 94		
7838.....	19	7876-60 ^(D)	93		
7839.....	19	7876-80 ^(D)	93		

CEV

CEV39L.....	87
CEV103BG.....	85
CEV103GH.....	85
CEV103P6.....	83, 84
CEV125P6.....	83, 84
CEV127T3.....	83
CEV143A3.....	83
CEV143A4.....	83
CEV143A7.....	83
CEV143B7.....	83
CEV177A3.....	83
CEV179A5.....	83
CEV326L.....	84
CEV326M.....	84
CEV326P.....	84
CEV326V.....	84
CEV392D20.....	48
CEV392D30.....	48
CEV392G24.....	48
CEV392P20.....	48
CEV392R15.....	48
CEV392S20.....	48
CEV417.....	32
CEV418.....	32
CEV419.....	32
CEV628P5.....	89
CEV720BRUC.....	90
CEV720RU.....	90
CEV728BR5U.....	90
CEV728T5.....	89
CEV890.....	85
CEV890C.....	85
CEV891I.....	87
CEV891MU.....	91
CEV892.....	92
CEV893I.....	87
CEV894I.....	87

^(D) Distributed by Integra MicroFrance SAS (France) - For corresponding manufacturer part numbers, see table in annex

CEV894MU	91	CP310E.....	26	CP392-5R	47
CEV895I.....	87	CP330-3-O.....	22	CP392-8R	46
CEV895MU	91	CP330-4-O	22	CP392-9R.....	47
CEV896.....	85	CP332.....	40	CP392-10R	47
CEV896I.....	87	CP335.....	28	CP392BI	46
CEV897	86	CP335P	32	CP392BS	46
CEV897BG	86	CP344A.....	26	CP393-2	46, 47, 48, 73, 86
CEV897C.....	86	CP344AT	26	CP393-3	46, 47, 48, 73, 86
CEV898	85	CP344B.....	26	CP393-4	46, 47, 48, 73, 86
CEV898I.....	87	CP344BT	26	CP400.....	42
CEV898L.....	85	CP344C.....	26	CP400-1	40
CEV899I.....	87	CP344CT	26	CP400-2	44
CEV899U.....	91	CP344D	26	CP401	43
CEV984.....	61	CP344DT	26	CP406.....	40
CEV992.....	92	CP344E.....	26	CP407	42
CEV992D.....	92	CP344ET	26	CP409.....	44
CEV995MU	92	CP345	43	CP414.....	40
CEV996MU	92	CP351-1.....	38	CP415	42
CEV997MU	92	CP351-2	37	CP604.....	41
CEV998MU	92	CP351-3	37	CP604-15	41
CEV1019T5BU.....	88	CP351-5	38	CP604BR.....	46
CEV1039G5U	88	CP351-6	37	CP604M.....	49
CEV1039T5TBU	88	CP351-7.....	37	CP605.....	41
CEV6285R.....	89	CP352.....	39	CP605-15.....	41
CEV6385RU.....	89	CP352-1	39	CP605BR.....	46
CEV7285RU	90	CP352-2	39	CP605M	49
CEV8103G3	85	CP352-3	39	CP606	41
CEV8143A3	83	CP353.....	33	CP606-15	41
CEV8143A4	83	CP354.....	33	CP606A	41
CEV8143A7	83	CP354A	33	CP609	28
CEV8143B7	83	CP355.....	34	CP611	23
CEV8826L.....	84	CP355A	34	CP616-13.....	36
CEV8826M	84	CP355C.....	36	CP616-15.....	36
CEV8826P.....	84	CP356	33	CP625	23
CEV8826V	84	CP358.....	33	CP626	23
CEV10195CU	88	CP358A	33	CP627	23
CEV10195DU	88	CP362	34	CP628	27
CEV10195RU	88	CP363.....	35	CP637.....	35
CEV10395DU	88	CP365	36	CP818-8	31
CEV10395RU	88	CP367.....	34	CP818-10	31
		CP367-1.....	34	CP818-12.....	31
		CP390-1.....	49	CP818-15.....	31
		CP390-2	49	CP818-20.....	31
		CP390-3	50	CP821	24
		CP390-5	50	CP821E.....	71
		CP390-7	50	CP822-10.....	27
		CP390-8	49	CP822-12	27
		CP390L26	50	CP822-14	27
		CP391E.....	13, 49, 50, 70, 73	CP825.....	25
		CP391M	13, 49, 50, 70, 73	CP919	33
		CP391V.....	13, 49, 50, 70, 73	CP919A.....	33
		CP392-1R.....	46	CP921.....	36
		CP392-2R.....	46	CP922	35
		CP392-3R	47	CP922A.....	35

CP

CP16.....	33
CP16-1.....	33
CP17	27
CP17-1	27
CP17-2.....	27
CP17-3.....	27
CP21-3	28
CP21A-3.....	28
CP37	40
CP310.....	26
CP310D.....	26

CP922B.....	35
CP931.....	37
CP931-1.....	37
CP931-3.....	38
CP931-5.....	38
CP933-14.....	42
CP933-16.....	43
CP933-18.....	44
CP934.....	42
CP934-1.....	42
CP936.....	43
CP938-1.....	40
CP941.....	27
CP984.....	31
CP984-1.....	31
CP985.....	23
CP988-15.....	42
CP988-18.....	44
CP988-20.....	45
CP997.....	34
CP1107.....	51

M

M832.....	41
M833.....	41

MCEN

MCEN39L.....	69, 71
MCEN136SC.....	21, 95
MCEN770J30.....	22
MCEN770J40.....	22

MCL

MCL1BIS.....	71
MCL4.....	71
MCL5.....	71
MCL7.....	71
MCL10.....	66
MCL11.....	68
MCL12.....	67
MCL15.....	67
MCL16.....	68
MCL17.....	68
MCL18.....	67
MCL19.....	67
MCL19BIS.....	67
MCL25.....	67
MCL29.....	67
MCL30.....	67
MCL31.....	68
MCL33.....	67

MCL34.....	73
MCL35.....	9, 61
MCL37.....	62
MCL37C.....	62
MCL37CF.....	62
MCL37D.....	62
MCL37DF.....	62
MCL37G.....	62
MCL38N ^(D)	9, 61
MCL42.....	62
MCL46.....	64
MCL46A.....	64
MCL47.....	64
MCL48.....	71
MCL49.....	60
MCL49F.....	60
MCL51.....	62
MCL52.....	62
MCL53.....	62
MCL54.....	62
MCL55.....	74
MCL55-1.....	74
MCL55-2.....	74
MCL55-3.....	74
MCL55B.....	74
MCL55R.....	74
MCL55T4.....	74
MCL55T5.....	74
MCL55T6.....	74
MCL55U.....	74
MCL56BL.....	68
MCL56BR.....	68
MCL56PL.....	69
MCL56PR.....	69
MCL57.....	68
MCL58.....	72
MCL59.....	73
MCL62.....	73
MCL63.....	63
MCL63F.....	63
MCL64.....	63
MCL64F.....	63
MCL65A.....	64
MCL65AF.....	64
MCL65AS.....	64
MCL67.....	67
MCL68.....	67
MCL69.....	67
MCL75.....	61
MCL76.....	9, 61
MCL77.....	63
MCL78.....	63
MCL79.....	63
MCL81BL.....	68

MCL81BR.....	68
MCL81PL.....	69
MCL81PR.....	69
MCL82.....	68
MCL83.....	64
MCL83-1.....	64
MCL84.....	64
MCL88.....	60
MCL88-1.....	60
MCL88-2.....	60
MCL89.....	64
MCL89-1.....	9, 60, 64
MCL89-2.....	9, 64
MCL92-1.....	69
MCL93.....	68
MCL93-2.....	68
MCL94.....	68
MCL94G.....	71
MCL94IG.....	71
MCL94IP.....	69
MCL94IPR.....	69
MCL98.....	72
MCL100.....	9, 66
MCL100T15.....	66
MCL100T20.....	66
MCL101.....	72
MCL102.....	72
MCL103.....	66
MCL110.....	59
MCL111.....	59
MCL112.....	59
MCL112F.....	59
MCL112H.....	58, 59
MCL120.....	65
MCL121.....	65
MCL122.....	65
MCL123.....	65
MCL124.....	65
MCL124FL.....	65
MCL124FR.....	65
MCL124ST.....	65
MCL125.....	65
MCL125FL.....	65
MCL125FR.....	65
MCL125ST.....	65
MCL170 ^{(D)(t)}	9, 61
MCL171 ^{(D)(t)}	9, 61
MCL173 ^{(D)(t)}	9, 61
MCL174 ^{(D)(t)}	9, 61
MCL197 ^{(D)(t)}	9, 61
MCL200.....	5
MCL201.....	5
MCL205.....	70
MCL206.....	8

^(t) Not a medical product

^(D) Distributed by Integra MicroFrance SAS (France) - For corresponding manufacturer part numbers, see table in annex

MCLT21	82
MCLT21R	82
MCLT30	82
MCLT40	82
MCLT40R	82
MCLT50	82
MCLT50R	82

MCLW

MCLW10	72
MCLW11	72

MCM

MCM1R	21
MCM4BISR	20
MCM4R	20
MCM7BISR	21
MCM7R	21
MCM9 ^(D)	20
MCM10-0-5	20
MCM10-1-0	20
MCM12R	21
MCM13	20
MCM13-1	20
MCM25-3	9, 21
MCM970	21
MCM973D3	20
MCM973D5	20

MCO

MCO201-2-5	22
MCO201-3-0	22
MCO305	23
MCO731 ^(D)	93
MCO770-1-5	22
MCO770-2-0	22
MCO770-2-5	22
MCO770-3-0	22
MCO770-3-5	22
MCO770-4-0	22
MCO771-2-5	22
MCO771-3-0	22
MCO771-4-0	22
MCO803	23
MCO979	25
MCO988	25

MCR

MCR2A	3
MCR3A	3

P

P761-7	53
P761-8	53
P762-2	54
P762-4	54
P763	55
P764-1	54
P764-3	54
P764-5	54
P764-7	54
P764-11	54
P765-14	55
P765-16	55
P769	55
P770	57
P771	57

S

SM63 ^(D)	71
SM64 ^(D)	71
SM65 ^(D)	71

^(D) Distributed by Integra MicroFrance SAS (France) - For corresponding manufacturer part numbers, see table in annex



**Table for corresponding
manufacturer part numbers
For information purposes only**

Integra MicroFrance® product reference	Corresponding manufacturer part number
1003IG	M3IG
1003LI	M3LI
1004IG	M4IG
1005I	M5I
7798T	101
7798T1	101 B
7872-24	1224
7876-100	310
7876-120	312
7876-160	316
7876-60	306
7876-80	308
7960T40	731901
MCL170 ⁽¹⁾	CO101
MCL171 ⁽¹⁾	CO201
MCL173 ⁽¹⁾	CO100
MCL174 ⁽¹⁾	CO200
MCL197 ⁽¹⁾	CO103
MCL38N	EC-BLU50U090
MCM9	201/A
MCO731	430490
SM63	SM63
SM64	SM64
SM65	SM65

⁽¹⁾ Not a medical device

Global alphabetical index

A

Abitbol	64, 66, 70
Adapter	
<i>Adapter for connection holder and mouth-gag frame</i>	7, 8
<i>Adapter for endoscope for connection light fiber</i>	61
<i>Adapter for fiberoptic</i>	9, 61
<i>Adapter luer-lock for tube insert cleaning port</i>	69, 71, 87
<i>Adapter-Luer-lock angled adapter</i>	75
<i>Adapter-Luer-lock long connector</i>	75
Adenoid curette	15, 16
Adenoid punch	18
Adenotome	16
Adson	12, 41, 46, 49
Adson-Brown	41
Adson-Tubiana	41
Aesculap	13, 46, 47, 48, 49, 50, 70, 73, 86
Allis	56, 91
Allis-Coakley	12
Approximator	20
April	5

B

Babcock	57, 87
Backauss	56
Ball dissector	75
Barraquer-Comtet	21
Barraya	42, 43, 44
Becker	51
Belghiti	48
Benninger	78
Berchtold	13, 46, 47, 48, 49, 50, 70, 73, 86
Bipolar	
<i>Bipolar Cable</i>	46, 47, 48, 73, 86
<i>Bipolar forceps</i>	46, 47, 73, 86
<i>Bipolar irrigation forceps</i>	48
Birket	11
Bizeau	30
Blade holder for knife	69
Blade	
<i>Micro Otologic blade spear sterile disposable</i>	69
<i>Replacement blades for pylorotom</i>	85
<i>Tonsil blade</i>	17
Blitzer	72
Blondiau	13

Boettcher	34
Bouchayer	9, 61, 63, 66, 67, 68, 72, 74, 96
Bourgeois	11
Bovie	13, 49, 50, 70, 73
Bowa	13, 46, 47, 48, 49, 50, 70, 73, 86
Brasnu	9, 64, 66
Bregeat	35
Brophy	34
Brünings	17

C

Cable	
<i>Bipolar cable</i>	46, 47, 48, 73, 86
<i>Monopolar cable</i>	13, 49, 50, 70, 73
Camo®	3, 4, 5, 9
Canuyt	2
Carpenter	13
Casiano	74
Castroviejo	40
Chabolle	3
Chambon	50
Chaput	56
Chatelier	11
Clamp	20
Claoué	43
Conmed	13, 49, 50, 70, 73
Cottle	23, 43
Cotton carrier	75
Crile	54
Crile-Wood	51, 52
Cup	93
Curette	
<i>Blunt curette</i>	13
<i>Curved curette</i>	75

D

Dauphin	59
Dautrey	31
Davis-Boyle	4
De Lagausie	92
Debakey	42, 44, 45
Dédo-Frèche	64
Descottes	32
Desmarres	27
Dilator	19

Dissector	
<i>Curved dissector</i>	19
<i>Dissector</i>	92
<i>facial nerve dissector</i>	19
Dousset	48
Doyen	2, 6

E

Elevator	
<i>Angled elevator</i>	68, 69
<i>Curved elevator</i>	23, 68, 69, 82
<i>Curved elevator and Pilar retractor</i>	13, 14
<i>Double-ended elevator</i>	13, 23
<i>Elevator and dissector</i>	13
<i>Elevator suction tube with finger control</i>	13
<i>Septum elevator graduated</i>	23
<i>Thyroplasty elevator</i>	75

Elevator suction tube

<i>Suction tube elevator malleable</i>	82
<i>Monopolar elevator suction tube</i>	13
Elhadad	90
Emc	46, 47, 48, 73, 86
Erbe	13, 46, 47, 48, 49, 50, 70, 73, 86

F

Farabeuf	25, 27
Ferris-Smith	12
Fiberoptic	9, 61
Fisher	14
Fleury	23, 25
Forceps	
<i>Adenoid forceps</i>	11, 12
<i>Alligator forceps</i>	59, 67, 70, 76, 78, 92
<i>Babcock forceps</i>	46, 91
<i>Bipolar forceps</i>	46, 47, 73, 86
<i>Bipolar irrigation forceps</i>	48
<i>Columella dissecting forceps</i>	43
<i>Crocodile forceps</i>	58, 59
<i>Cup forceps</i>	58, 59, 67, 76, 78, 79, 80
<i>Delicate forcep</i>	41
<i>Dissecting forceps</i>	20, 40, 41, 42, 43, 44, 45
<i>Fenestrated forceps</i>	81, 91, 92
<i>Fixation forceps with lock</i>	43
<i>Forceps serrated jaws</i>	79, 80, 81
<i>Forceps with teeth</i>	55, 56, 57
<i>Grasping forceps</i>	91
<i>Haemostatic forceps</i>	11, 12, 53, 54, 55, 57
<i>Heart-shaped forceps</i>	67

<i>Indirect alligator forceps</i>	77
<i>Indirect cupped forceps</i>	77
<i>Indirect heart-shaped forceps</i>	77
<i>Jewelers forceps</i>	20
<i>Heart-shaped forceps with suction</i>	70
<i>Monopolar forceps</i>	49, 50, 70, 81
<i>Retractor forceps</i>	68
<i>Sponge and fragment forceps</i>	12
<i>Tonsil forceps</i>	11, 12
Fox	33
Frèche	73
Freer	23

G

Garabédian	62, 66, 71
Garcin	62
Gayet	48
Gilbert O'Brien	20
Gillies	27
Graefe	43
Grasper	76, 78
Grooved director	19
Guerrier	19

H

Halsey	51
Halsted	53
Halsted-Mosquito	53
Handle	
<i>Angled handle</i>	88
<i>Axial handle</i>	89
<i>Ergonomic handle</i>	90
<i>Handle for suction tube</i>	85
<i>Handle for tonsil blades</i>	17
<i>Scalpel handle</i>	13, 24, 71
<i>Stylus handle with ratchet for inserts</i>	69, 71
Hartmann-Mosquito	53
Heavy	25
Henke	13
Henry	81
Hook	
<i>Blunt hook</i>	71
<i>Double hook</i>	75
<i>Monopolar hook</i>	81, 85
<i>Round sharp hook</i>	27
House	30
Howarth	23
Humby	27

Hurd	13, 14
Huttenbrink	66

I

Injection needle	72, 74, 75, 77
Injector	
<i>Injector</i>	74
<i>Injector Oro-Tracheal</i>	74
<i>Injector-Luer-lock adapter for pistol</i>	74
Insert	87
Instrument holder	75, 77
Irrigation tube	20

J

Jackson	59
Jako	80
Jankowski	22
Jennings	6
Joseph	26, 33, 34, 36
Jost	13

K

Kelly	54
Kilner	3
Kilner-jost	34
King	18
Kleinsasser	79
Knapp	28
Knife	
<i>Flap Knife</i>	75, 77
<i>Knife blade lancet</i>	68
<i>Knife blade sterile disposable</i>	71, 72
<i>Knife round curved</i>	72
<i>Lancet knife handle and 3 blades</i>	68
<i>Oval knife</i>	71
<i>Retractable knife</i>	85
<i>Sharp knife</i>	75
<i>Tonsil knife</i>	13, 14
<i>Vascular knife</i>	75, 77
Kocher	54

L

Laborde	19
Lacau	60
Laforce	16
Lamidey	13, 46, 47, 48, 49, 50, 70, 73, 86
Laryngeal dilator	77
Laryngeal sprinkler	72

Laryngoscope	
<i>Anterior commissure laryngoscope</i>	65
<i>Diverticuloscope</i>	60
<i>Dual suction tube replacement</i>	65
<i>Endoscope handle for Hypopharyngoscope and Esophagoscope</i>	58, 59
<i>Esophagoscope</i>	58
<i>Hypopharyngoscope</i>	59
<i>Laryngoscope</i>	62, 63, 64
<i>Laryngoscope arm holder</i>	9, 61
<i>Light fiber for laryngoscope</i>	9, 62, 63, 64, 65
<i>Light fiber for diverticuloscope</i>	60
<i>Light fiber for Esophagoscope</i>	58
<i>Light fiber for Hypopharyngoscope</i>	59
<i>Posterior commissure laryngoscope</i>	64
<i>Suction tube for diverticuloscope</i>	60
<i>Suction tube for endoscopes</i>	9, 60, 64
<i>Suction tube for laryngoscope</i>	64
<i>Vallecula laryngoscope</i>	65
Le Mée	10
Lecouteur	10
Legent	62
Léger	36
Lempert	22, 25
Lérault	13
Leriche	53
Lermoyez	15
Leroux-Robert	32
Lowinger	72
Lusk	16

M

Magnan	46
Martel	55
Martin	13, 46, 47, 48, 49, 50, 70, 73, 86
Masson	6
Mayo	39
Mayo-Hegar	51
McCabe	19
McIndoe	42, 43
McKenty	23
Meltzer	18
Metzenbaum	37, 38
Middleton	16
Mirror	75

Monopolar	
<i>Alligator forceps</i>	70
<i>Monopolar cable</i>	13, 49, 50, 70, 73
<i>Monopolar elevator suction tube</i>	13
<i>Monopolar forceps</i>	49, 50, 70
<i>Monopolar hook</i>	81, 85
<i>Monopolar pick</i>	13, 73
<i>Monopolar suction tube</i>	73
Montupet	84, 85, 91, 92
Morinière	7, 8
Mosnier	32
Mosquito	53
Moure	15, 19
Mouth guard	3, 4, 5, 9
Mouth-gag	
<i>Dental mouth-gag guard</i>	3, 4, 5, 9
<i>Mouth-gag frame</i>	3, 4, 5, 7, 8
<i>Mouth-gag blade</i>	3, 4, 8
<i>Mouth gag ring blade</i>	3, 4, 6, 7, 8
<i>Mouth-gag mini-invasive surgery complete</i>	8
<i>Mouth-gag with tongue depressor</i>	6
<i>Palatine blade for mouth-gag</i>	3
<i>Tightening key for mouth-gag frame</i>	8
Mustard	61
N	
Needle-driver	78
Needle-holder	
<i>Needle-holder diamond jaws</i>	51
<i>Needle-holder smooth jaws</i>	21
<i>Needle-holder serrated jaws</i>	68
<i>Tungsten needle-holder</i>	51, 52, 69, 71, 92
<i>Tungsten needle-holder insert</i>	69, 71
Négus	11
O	
O'Brien	21
Obwegeser	26
Obwegeser-Tessier	26
Offret	33
Olympus	9, 61
Ombredanne	57
Operating room table clamp	61
Oro-tracheal	74
O'Shaugnessy	19

P	
Parsons	72
Partensky	48
Péan	55
Peanut holder	82
Peretti	73
Pérouse	69
Pessey	32
Pick	13, 73
Pignat	63
Plate for chest holder	9, 61
Plester	25
Portmann	10, 11
Potts-Smith	44
Précelle	43
Probe	
<i>Double probe</i>	72
<i>Round probe</i>	81

R	
Ragnell	36
Raspatory	
<i>Curved raspatory</i>	23, 25, 26
<i>Straight raspatory</i>	26
Redon	19
Reinberg	92
Retractor	
<i>Articulated self-retaining retractor</i>	30
<i>Blunt retractor</i>	27, 28, 32, 71, 82
<i>Double retractor</i>	27, 28, 31, 32
<i>Lid retractor</i>	27
<i>Malleable blade retractor</i>	31
<i>Self-retaining retractor</i>	29
<i>Sharp retractor</i>	27, 28
<i>Tracheal retractor sharp hook</i>	19
<i>Vascular strip retractor</i>	30
Reynolds	36
Reyt	60
Robotic	
<i>Robotic ball hook elevator</i>	82
<i>Robotic Bivalve Retractor</i>	82
<i>Robotic malleable nerve eye suction tube</i>	82
<i>Robotic muscle retractor</i>	82
<i>Robotic suction elevator malleable</i>	82
Rochester-Péan	54
Ronis	18

Ruault	13
Ryder	51

S

Sage	18
Sataloff	65, 66, 75, 76, 77
Schmidt	11, 12
Schmidt-Boettcher	12
Scissors	
Angled scissors	68, 80
Atraumatic scissors	21
Blunt curved micro scissors	21
Curved scissors	19, 21, 33, 34, 35, 36, 37, 38, 39, 68, 79, 80, 81
Curved scissors insert	87
Indirect scissors	77
Micro scissors	21, 68, 72, 78, 79, 80
Nasal scissors	36
Straight scissors	33, 34, 35, 37, 39, 91, 92
Tenotomy scissors	35
Sealing cap	83, 84
Sébileau	23, 25
Seemann-Seiffert	6
Senn-Miller	28
Shea	35
Shear	19
Sickle knife	
Curved sickle knife	75, 77
Sickle knife sharp	71
Straight sickle knife	75, 77
Silicone cover	9, 21
Sluder	17
Soubrane	48
Spatula	75
St Claire Thompson	12
Sterilization case	
Stainless steel sterilization case	9, 58, 77, 94
Plastic sterilization case	21, 95, 96
Stevens	35
Storz	9, 13, 46, 47, 48, 49, 50, 61, 70, 73, 86
Stratte	52
Streiff	33
Suction irrigation tube	
Blunt eyes cannula graduated	85
Blunt eyes suction irrigation tube	85
Suction irrigation tube with finger control	22
Suction tube	

Blunt eyes suction tube	9, 58, 59, 60, 66
Blunt suction tube removable tip	14
Dual suction tube	66
French velvet eye suction tube	66
Indirect suction tube	77
Insulated suction tube	66, 70
Monopolar suction tube	73
Nerve eye suction tube	82
Suction tube	66
Suction tube with finger control	22, 66
Surgical instrument paraffin oil	93
Sutter	13, 46, 47, 48, 49, 50, 70, 73, 86
Suture knot-pusher	78

T

Table	61
Terrier	55
Terris	82
Tongue depressor	
Double tongue depressor	2, 10
Fenestrated tongue depressor	2
Tongue depressor with suction tube and basket	10
Tonsil snare	17, 18
Toriumi	95
Towel clamp	55, 56
Tray	93
Trocar	
Tip trocar	81, 83, 84
Body trocar	84
Magnetic trocar head	83
Magnetic valve for trocar head	83
Silicone valve for trocar head	83, 84
Smooth cannula	83
Trocar holder ring	81
Tyding	18

V

Vacher	17
Valleylab	13, 46, 47, 48, 49, 50, 70, 73, 86
Vanas	21
Volkman	28

W

Weitlaner	29
Weitlaner-Beckmann	30
Wertheimer	22
White	11
Wire	
<i>Snare wire</i>	17, 18
<i>Wire</i>	18
Wolf	9, 13, 46, 47, 48, 49, 50, 61, 70, 73, 86
Woo	72
Wormald	21, 95

Y

Yankauer	14
----------	----



Alphabetical index
Search by name

A

Abitbol	Alligator forceps	70
	Insulated suction tube with finger control	66, 70
	Laryngoscope	64
	Laryngoscope 4 channels	64
	Heart-shaped forceps monopolar with suction	70
	Light fiber for laryngoscope	64
	Suction tube for laryngoscope	64
	Monopolar fenestrated forceps	70
Adson	Bipolar forceps	46
	Dissecting forceps	41
	Haemostatic forceps	12
	Monopolar forceps	49
Adson-Brown	Dissecting forceps	41
Adson-Tubiana	Delicate forceps serrated jaws	41
	Dissecting forceps	41
Aesculap	Bipolar cable	46, 47, 48, 73, 86
	Monopolar cable	13, 49, 50, 70, 73
Allis	Forceps with teeth	56, 91
Allis-Coakley	Tonsil forceps	12
April	Mouth-gag frame	5

B

Babcock	Haemostatic forceps	57
	Insert insulated tube	87
Backauss	Towel clamp	56
Barraquer-Comtet	Needle-holder	21
Barraya	Dissecting forceps	42, 43, 44
Becker	Needle-holder	51
Belghiti	Bipolar irrigation forceps	48
Benninger	Downbiting cup forceps	78
	Alligator forceps	78
	Heart-shaped grasper	78
	Micro scissors	78
	Needle-driver	78
	Suture knot-pusher	78
Berchtold	Bipolar cable	46, 47, 48, 73, 86
	Monopolar cable	13, 49, 50, 70, 73
Birket	Haemostatic forceps	11
Bizeau	Articulated self-retaining retractor	30
Blitzer	Knife sterile disposable sickle tip	72
Blondiau	Blunt curette	13
Boettcher	Curved scissors pointed blades	34

Bouchayer	Alligator forceps	67
	Angled elevator	68
	Micro scissors	68
	Injection needle	72, 74
	Cup forceps	67
	Elevator	68
	Heart-shaped forceps	67
	Knife blade lancet	68
	Lancet knife handle and 3 blades	68
	Laryngoscope	63
	Laryngoscope arm holder	9, 61
	Light fiber for laryngoscopes	63
	Needle-holder	68
	Plate for chest holder	9, 61
	Retractor forceps	68
	Sterilization case	96
	Suction tube	66
Bourgeois	Tonsil forceps	11
Bovie	Monopolar cable	13, 49, 50, 70, 73
Bowa	Bipolar cable	46, 47, 48, 73, 86
	Monopolar cable	13, 49, 50, 70, 73
Brasnu	Blunt eyes suction tube	9, 66
	Posterior commissure laryngoscope	64
Bregeat	Curved scissors	35
Brophy	Curved scissors pointed blades	34
	Straight scissors pointed blades	34
Brünings	Snare wire	17
	Tonsil snare	17
C		
Camo®	Single use dental mouth guard	3, 4, 5, 9
Canuyt	Fenestrated tongue depressor	2
Carpenter	Double-ended elevator	13
Casiano	Transcervical laryngeal injection medialization needle	74
	Transcervical laryngeal injection medialization needle handle	74
	Transcervical laryngeal injection medialization needle trocar obturator	74
Castroviejo	Dissecting forceps horizontal teeth and plateform	40
	Dissecting forceps oblique teeth and plateform	40
Chabolle	Mouth-gag ring blade	3
Chambon	Monopolar forceps smooth jaws	50
Chaput	Forceps with teeth	56
Chatelier	Adenoid forceps spoon jaws	11
Claoué	Dissecting forceps	43
Conmed	Monopolar cable	13, 49, 50, 70, 73

Cottle	Columella dissecting forceps	43
	Septum elevator gratuated	23
Crile	Haemostatic forceps curved jaws	54
	Haemostatic forceps straight jaws	54
Crile-Wood	Tungsten needle-holder	51, 52

D

Dauphin	Hypopharyngoscope	59
	Light fiber for Hypopharyngoscope	59
Dautrey	Double retractor blunt	31
Davis-Boyle	Left mouth-gag frame	3
	Mouth-gag blade	3
	Mouth-gag blade with suction tube	3
De Lagausie	Alligator forceps serrated jaws	92
	Dissector	92
	Fenestrated forceps	92
	Straight scissors	92
Debakey	Dissecting forceps serrated jaws	42, 44, 45
Dédo-Frèche	Laryngoscope	64
	Light fiber for laryngoscope	64
	Suction tube for laryngoscope	64
Descottes	Double retractor blunt	32
Desmarres	Blunt retractor	27
	Lid retractor	27
Dousset	Bipolar irrigation forceps smooth jaws	48
Doyen	Double tongue depressor	2
	Mouth-gag	6

E

Elhadad	Ergonomic handle	90
Emc	Bipolar cable	46, 47, 48, 73, 86
Erbe	Bipolar cable	46, 47, 48, 73, 86
	Monopolar cable	13, 49, 50, 70, 73

F

Farabeuf	Curved raspatory	25
	Double retractor blunt	27
Ferris-Smith	Sponge and fragment forceps	12
Fisher	Tonsil knife curved serrated blades	14
Fleury	Curved elevator	23
	Curved raspatory	25
Fox	Curved scissors pointed blades	33
	Straight scissors pointed blades	33
Frèche	Monopolar electrod pick	73
Freer	Double-ended elevator	23

G

Garabédian	Blunt eyes suction tube	66
	Laryngoscope blunt	62
	Scalpel handle	71
	Stylus handle with ratchet for inserts	71
	Tungsten needle-holder	71
	Tungsten needle-holder insert straight serrated jaws	71
Garcin	Laryngoscope	62
Gayet	Bipolar irrigation forceps	48
Gilbert O'Brien	Approximator	20
Gillies	Round sharp hook	27
Graefe	Fixation forceps with lock	43
Guerrier	S curved scissors blunt tip	19
	Tracheal retractor sharp hook	19

H

Halsey	Tungsten needle-holder	51
Halsted	Haemostatic forceps	53
Halsted-Mosquito	Haemostatic forceps	53
Hartmann-Mosquito	Haemostatic forceps	53
Heavy	Curved raspatory	25
Henke	Double-ended elevator	13
Henry	Blunt tip trocar	81
	Curved micro scissors	81
	Fenestrated forceps monopolar	81
	Forceps serrated jaws	81
	Monopolar hook	81
	Round probe	81
	Trocar holder ring	81
House	Vascular strip retractor	30
Howarth	Double-ended elevator	23
Humby	Sharp retractor	27
Hurd	Curved elevator and Pilar retractor	13, 14
Huttenbrink	Dual suction tube	66

J

Jackson	Alligator forceps serrated jaws	59
Jako	Micro scissors	80
	Micro cup forceps	80
	Micro forceps serrated jaws	80
	Suction tube with finger control	22
Jankowski	Suction tube with finger control	22
Jennings	Mouth-gag	6
Joseph	Curved raspatory	26
	Curved scissors blunt tip	36
	Straight raspatory	26
	Scissors pointed blades	33, 34
Jost	Elevator and dissector	13

K

Kelly	Haemostatic forceps	54
Kilner	Left mouth-gag frame	3
	Mouth-gag ring blade	3
	Palatine blade for Mouth-gag	3
Kilner-jost	Curved scissors pointed blades	34
King	Adenoid punch	18
Kleinsasser	Cup forceps	79
	Micro forceps serrated jaws	79
	Micro left forceps serrated jaws	79
	Micro right forceps serrated jaws	79
	Micro scissors	79
Knapp	Blunt retractor	28
	Sharp retractor	28
Kocher	Haemostatic forceps	54

L

Laborde	Tracheal dilator	19
Lacau	Articulated diverticuloscope without fiber	60
	Light fiber for diverticuloscope	60
Laforce	Adenotome	16
Lamidey	Bipolar cable	46, 47, 48, 73, 86
	Monopolar cable	13, 49, 50, 70, 73
Le Mée	Tongue depressor	10
Lecouteur	Double tongue depressor with basket	10
Legent	Laryngoscope blunt	62
	Light fiber for laryngoscope	62
Léger	Curved scissors blunt tip	36
Lempert	Curved raspatory	25
	Suction tube with finger control	22
Lérault	Monopolar elevator suction tube	13

Leriche	Haemostatic forceps	53
Lermoyez	Adenoid curette	15
Leroux-Robert	Blunt retractor	32
Lowinger	Double probe	72
Lusk	Adenoid curette	16

M

Magnan	Bayonet bipolar forceps	46
Martel	Forceps with teeth	55
Martin	Bipolar cable	46, 47, 48, 73, 86
	Monopolar cable	13, 49, 50, 70, 73
Masson	Mouth-gag with tongue depressor	6
Mayo	Scissors beveled blades	39
Mayo-Hegar	Tungsten needle-holder	51
McCabe	facial nerve dissector	19
McIndoe	Dissecting forceps	42, 43
McKenty	Curved double raspatory	23
Meltzer	Adenoid punch	18
Metzenbaum	Scissors blunt tip	37, 38
Middleton	Adenoid curette	16
Montupet	Babcock forceps	91
	Body trocar silicon valve smooth cannula	84
	Body trocar silicon valve threaded cannula	84
	Fenestrated forceps	91
	Monopolar hook	85
	Needle-holder straight tungsten jaws	92
	Pyramidal trocar tip	84
	Straight scissors serrated blades	91
Morinière	Adapter for connection holder and mouth-gag frame	7, 8
	Mouth-gag blade	8
	Mouth-gag ring blade	7, 8
	Mouth-gag frame	7, 8
	Mouth-gag mini-invasive surgery complete	8
	Tightening key for Mouth-gag frame	8
Mosnier	Double retractor blunt	32
Mosquito	Haemostatic forceps	53
Moure	Adenoid curette	15
	Adenoid curette with basket	15
	Shear serrated blades	19
Mustard	Table	61

N

Négus	Haemostatic forceps	11
--------------	---------------------	----

O

O'Brien	Needle-holder	21
Obwegeser	Curved raspatory	26
Obwegeser-Tessier	Sharp curved raspatory	26
Offret	Straight scissors pointed shorts blades	33
Olympus	Adapter for fiberoptic	9, 61
Ombredanne	Forceps with teeth	57
Oro-tracheal	Injection needle sterile disposable	74
	Injector with curved and straight cannula	74
O'Shaugnessy	Curved dissector	19

P

Parsons	Laryngeal sprinkler	72
Partensky	Bipolar irrigation forceps bayonet fenestrated jaws	48
Péan	Haemostatic forceps serrated jaws	55
Peretti	Bipolar forceps	73
Pérouse	Angled elevator	69
	Elevator curved	69
	Stylus handle without ratchet for inserts	69
	Tungsten needle-holder insert	69
Pessey	Blunt retractor	32
Pignat	Laryngoscope	63
	Light fiber for laryngoscope	63
Plester	Curved raspatory	25
Portmann	Tongue depressor	10
	Tonsil forceps with teeth	11
Potts-Smith	Dissecting forceps	44
Précelle	Dissecting forceps serrated angled jaws	43

R

Ragnell	Nasal scissors curved	36
Redon	Curved dissector	19
Reinberg	Needle-holder straight tungsten jaws	92
Reynolds	Curved scissors blunt tip	36
Reyt	Diverticuloscope	60
	Light fiber for diverticuloscope	60
	Suction tube for diverticuloscope	60
Rochester-Péan	Haemostatic forceps	54
Ronis	Adenoid punch	18
Ruault	Tonsil knife blunt tip	13
Ryder	Tungsten needle-holder	51

S

Sage	Tonsil snare	18
	Wire	18
Sataloff	Alligator forceps	76
	Anterior commissure laryngoscope	65
	Ball dissector	75
	Cotton carrier	75
	Collagen injection needle	75
	Curved curette	75
	Injection needle	77
	Curved sickle knife	75, 77
	Spatula	75
	Double hook	75
	Downbiting cup forceps	76
	Dual suction tube replacement	65
	French velvet eye suction tube	66
	Indirect alligator forceps	77
	Indirect cupped forceps curved left	77
	Indirect heart-shaped forceps	77
	Indirect scissors	77
	Indirect suction tube	77
	Instrument holder	75, 77
	Laryngeal dilator	77
	Light fiber replacement for laryngoscope	65
	Luer-lock adapter	75
	Mini Micro Flap Knife	75, 77
	Mirror	75
	Percutaneous injection needle	75
	Heart-shaped grasper	76
	Sharp right angled knife	75
	Stainless steel sterilization case	77
	Straight sickle knife	75, 77
	Thyroplasty elevator	75
	Vallecula laryngoscope	65
Vascular knife	75, 77	
Schmidt	Tonsil haemostatic forceps	11, 12
Schmidt-Boettcher	Tonsil haemostatic forceps	12
Sébileau	Curved elevator	23
	Curved raspatory	25
Seemann-Seiffert	Mouth-gag	6
Senn-Miller	Double retractor	28
Shea	Curved scissors blunt tip	35
Sluder	Handle for tonsil blades	17
	Tonsil blade	17
Soubrane	Bipolar irrigation forceps smooth jaws	48

St Claire Thompson	Adenoid forceps open jaws	12
Stevens	Tenotomy scissors blunt tip	35
Storz	Adapter for endoscope for connection light fiber	61
	Adapter for fiberoptic	9, 61
	Bipolar cable	46, 47, 48, 73, 86
	Monopolar cable	13, 49, 50, 70, 73
Stratte	Tungsten needle-holder	52
Streiff	Scissors pointed blades	33
Sutter	Bipolar cable	46, 47, 48, 73, 86
	Monopolar cable	13, 49, 50, 70, 73
T		
Terrier	Haemostatic forceps	55
Terris	Blunt curved elevator	82
	Blunt retractor	82
	Nerve eye suction tube with finger control	82
	Peanut holder	82
	Robotic ball hook elevator	82
	Robotic Bivalve Retractor	82
	Robotic malleable nerve eye suction tube	82
	Robotic muscle retractor	82
	Robotic suction elevator malleable	82
	Suction tube elevator malleable	82
Toriumi	Sterilization case	95
Tyding	Tonsil snare straight tip	18
V		
Vacher	Tonsil snare	17
Valleylab	Bipolar cable	46, 47, 48, 73, 86
	Monopolar cable	13, 49, 50, 70, 73
Vanas	Micro scissors	21
Volkman	Sharp retractor	28
W		
Weitlaner	Self-retaining retractor	29
Weitlaner-Beckmann	Articulated self-retaining retractor	30
Wertheimer	Suction tube with finger control	22
White	Tonsil forceps with teeth	11
Wolf	Adapter for fiberoptic	9, 61
	Bipolar cable	46, 47, 48, 73, 86
	Monopolar cable	13, 49, 50, 70, 73
Woo	Micro scissors	72
Wormald	Silicone sterilization case	21, 95

Y

Yankauer

Blunt suction tube curved removable tip

14

Integra® MicroFrance®

Integra ENT - Throat catalogue

Manufacturers :



Integra MicroFrance SAS (France)
Le Pavillon ■ 03160 Saint Aubin le Monial ■ France



Integra York PA, Inc
589 Davies Drive
York, PA 17402 ■ USA



Integra LifeSciences Sciences (France) SAS
Immeuble Séquoia 2
97 Allée Alexandre Borodine
Parc Technologique de la Porte des Alpes
69800 Saint Priest ■ France
Tél. : +33 (0)4 37 47 59 00 ■ Fax : +33 (0)4 37 47 59 30



Swann Morton Ltd
Penn Works ■ Owlerton Green ■ Sheffield
South Yorkshire S6 2BJ ■ Royaume Uni

Manufacturers with CE Class I products only :



Agencinox
Zone Industrielle
89110 Aillant sur Tholon ■ France



Chemische Fabrik Dr. Weigert GmbH & Co.
Mühlenhagen
D-20539 Hamburg ■ Allemagne



Moria S.A.
15, rue Georges Besse
92160 Antony ■ France



Directa AB
Box 723
19427 Upplands Vasby ■ Suède



Sunoptic Technologies
6018 Bowdendale Avenue
Jacksonville 32216 ■ Florida USA



RMS - UK Limited
28 Trinity Road ■ Nailsea
Somerset BS48 4NU ■ Royaume Uni

Availability of these products might vary from a given country or region to another, as a result of specific local regulatory approval or clearance requirements for sale in such country or region.

- Consult product labels and inserts for any indications, contraindications, hazards, warnings, precautions, and instructions for use.
- Non contractual document. The manufacturer reserves the right, without prior notice, to modify the products in order to improve their quality.
- Warning: Applicable laws restrict these products to sale by or on the order of a physician.

Additional information for EMEA Customers only :

Products mentioned in this document are CE class I, Is, IIa or IIb devices. Contact Integra should you need any additional information on devices classification. All the medical devices mentioned on this document are CE marked according to European council directive 93/42/EEC on medical devices and its relatives. References that are not medical devices are identified with the indication "NOT A MEDICAL DEVICE".

Products marked with the symbol ^(®) are distributed by Integra MicroFrance SAS (France)

Date of last révision : 01/2018

For more information, please contact customer service :

Europe, Middle-East, Africa

International : +33 (0) 437 47 59 50 ■ +33 (0) 437 47 59 25 (Fax) ■ csmea@integralife.com
France : +33 (0) 437 47 59 10 ■ +33 (0) 437 47 59 29 (Fax) ■ custsvcf@integralife.com
United Kingdom : +44 (0) 1264 345 780 ■ +44 (0) 1264 363 782 (Fax) ■ custsvcs.uk@integralife.com
Germany : +49 (0) 2102 5535 6200 ■ +49 (0) 2102 5536 636 (Fax) ■ custsvcg@integralife.com
Benelux : +32 (0)2 257 4130 ■ +32 (0)2 253 2466 (Fax) ■ custsvcbenelux@integralife.com
Italy : +39 (0)2 577 8921 ■ +39 (0)2 575 113 71 (Fax) ■ custsvcitaly@integralife.com
integralife.eu/contact

Integra and the Integra logo are registered trademarks of Integra LifeSciences Corporation or its subsidiaries in the United States and/or other countries.

MicroFrance is a trademark of Integra LifeSciences Corporation or its subsidiaries. All other trademarks and product names are the property of their respective owners.

© 2018 Integra LifeSciences Corporation. All rights reserved.

0335699-2-EN

DOCUMENT FOR USE IN EUROPE, MIDDLE-EAST AND AFRICA ONLY.